

MDC-211-ZT

User Manual

Warranty

All products manufactured by ICP DAS are under warranty regarding defective materials for a period of one year, beginning from the date of delivery to the original purchaser.

Warning

ICP DAS assumes no liability for any damage resulting from the use of this product. ICP DAS reserves the right to change this manual at any time without notice. The information furnished by ICP DAS is believed to be accurate and reliable. However, no responsibility is assumed by ICP DAS for its use, or for any infringements of patents or other rights of third parties resulting from its use.

Copyright

Copyright © 2018 by ICP DAS. All rights are reserved.

Trademarks

Names are used for identification purposes only and may be registered trademarks of their respective companies.

Technical Support

If you have any problems, feel free to contact us via email at service@icpdas.com.

Table of Contents

1. Introduction	3
1.1. Introduction to MDC-211-ZT	3
1.2. Product Features.....	4
1.3. Specifications	6
1.4. Size (Unit : mm)	7
1.5. Configuration Instructions	8
2. Getting Started With MDC-211-ZT	9
2.1. Preparation.....	10
2.2. Login MDC-211-ZT Web Interface	13
2.3. Set Port Information	14
2.4. Set MDC-211-ZT as Modbus Master	17
2.5. Set MDC-211-ZT as Modbus Slave	19
2.6. Check Modbus RTU Device Communication Status	21
2.6.1. Check polling status of Modbus command	21
2.6.2. Inquire Corresponding Modbus Register Address	23
2.6.3. Testing I/O Channel Status of Modbus RTU Device	24
3. Export and Import the System Settings	25
3.1. Export and Import the Configurations	25
3.2. Format Descriptions for the Configuration File (*.csv)	27
4. Parameter Descriptions	32
4.1. Communication Interface Parameter Descriptions	32
4.1.1. ZigBee Communication Interface.....	32
4.1.2. Serial Port Communication Interface	35
4.2. Modbus Protocol Parameter Descriptions	36
4.2.1. Modbus Master Setting Parameters	36
4.2.2. Modbus Slave Setting Parameters	37

5. FAQ	38
Q1 - What are the maximum numbers of polling definition and Internal Register in a MDC-211-ZT?	38
Q2 - What is the maximum number of data can be accessed in one command from a Modbus Master device?	38
Q3 - How are the Internal Registers corresponding to the polled data in a MDC-211-ZT?	38
Q5 - How to read each MDC-211-ZT command status via the Modbus communication?	40
Q6 - How to update the firmware?	42
6. Appendix	44
6.1. LED Indicator State Descriptions	44

1. Introduction

This section describes the functions, features, software, and hardware specifications of the MDC-211-ZT Modbus data concentrator.

1.1. Introduction to MDC-211-ZT

◆ Functions

MDC-211-ZT Modbus data concentrator developed by ICP DAS, with Ethernet, ZigBee Wireless, RS-232 and RS-485 communication interfaces, can link the Modbus RTU devices to the Ethernet network. MDC-211-ZT can read the data of Modbus RTU device according to the user-defined command table, and integrate the data of different Modbus RTU devices into the format of the continuous address so that the remote monitor host can connect to MDC-211-ZT from Ethernet to access the data of multiple Modbus RTU devices at once.

Through MDC-211-ZT's Modbus data centralized management function, as well as the Ethernet network convenient link and the communication ability, can quickly establish the stable remote monitoring system, let the user be able to easily simplify the data acquisition difficulty, and reduces the Ethernet network traffic load, enhances the system efficiency.

◆ Advantages

The advantages of MDC-211-ZT Modbus data concentrator, not only to help users manage the Modbus RTU devices near the RS-232 and RS-485, even in the distance tough cabling environment, can through the ZigBee wireless mesh network communication advantages, easy to link the remote distributed ZT-2000 I/O series modules with the general Modbus RTU devices.

In particular, in the widely used Supervisory Control and Data Acquisition (SCADA), with simple settings, MDC-211-ZT Modbus data concentrator can link the distributed Modbus RTU devices and the ZigBee I/O modules to the Ethernet network, which is the best solution for the user to establish the remote monitoring control system quickly.

1.2. Product Features

◆ Support Modbus RTU Master

The ZigBee, RS-485, or RS-232 on the MDC-211-ZT can be set as Modbus Master. MDC-211-ZT can read the data of the Modbus RTU device according to the user-defined command table, and integrate the data of different Modbus RTU devices into the format of the continuous address for centralized management.

◆ Support Modbus TCP/RTU Slave

The ZigBee, RS-485, RS-232 or Ethernet on the MDC-211-ZT can be set as Modbus Slave, so the control host can access multiple Modbus RTU devices via MDC-211-ZT at once.

By establishing the function of Modbus Master and Modbus Slave, the Modbus data monitoring control system will be more efficient, stable and flexible to meet the diverse application sites.

◆ Support Web-based UI Operations

MDC-211-ZT provides a simple, friendly Web interface (UI), users can login the MDC-211-ZT Web page via a Web Browser to set up and real-time detect the MDC-211-ZT for the communication status and update frequency of each Modbus RTU command.

The screenshot displays the web interface for configuring Modbus settings and monitoring internal registers. The left panel shows the 'ZigBee' configuration tab with the following settings:

- Modbus Mode: Modbus Master
- Modbus Timeout: 200 (ms)
- Modbus Retry: 3
- Polling Interval: 0 (ms)

Below these settings is a table for 'Modbus Device' configuration:

Name	Address	0x	1x	3x	4x	
ZT-2060	0x01	4	6			
ZT-2060	0x02	2/2	6			
ZT-2043	0x03	14				

The right panel shows two 'Internal Register' monitoring windows. The top window is for 'ZigBee' and the bottom for 'RS-485'. Each window includes a 'RESET' button and a table of registers with their status.

Internal Register (ZigBee)

ID	Number	Remote	MDC-211-ZT	Status
01	#001	[00000:00003]	[00000:00003]	GOOD
	#002	[10000:10005]	[10000:10005]	GOOD
	#003	[00000:00001]	[00004:00005]	GOOD
02	#004	[00002:00003]	[00006:00007]	GOOD
	#005	[10000:10005]	[10006:10011]	GOOD
03	#006	[00000:00013]	[00008:00021]	GOOD

Internal Register (RS-485)

ID	Number	Remote	MDC-211-ZT	Status
05	#007	[30000:30007]	[30000:30007]	GOOD
06	#008	[40000:40003]	[40000:40003]	GOOD

◆ Support Parameter Setting via CSV File

CSV (Comma-Separated Values) is a text file format that can be edited in spreadsheet software or plain text files and has the advantage of being easy to use, read and maintain. MDC-211-ZT parameter setting includes the Modbus TCP communication ID and port number, the Serial port communication parameters and the Modbus RTU commands that settings can also be edited in a *.csv file and import into the MDC-211-ZT from the Web UI, and then start to monitor the data of the remote Modbus RTU devices.

	A	B	C	D	E	F	G	H
9	#	SerialPort						
10	#	BaudRate	BaudRate	DataBit	Parity	StopBit		
11	*	RS-232	115200	8	0	1		
12	*	RS-485	115200	8	0	1		
13	#							
14	#	Modbus						
15	#	PortName	PortNo.	ModbusMc	ModbusID	Retry	Timeout	Interval
16	*	ZigBee	0	1	1	3	150	0
17	*	RS-232	1	2	1	3	200	20
18	*	RS-485	2	1	1	3	100	10
19	*	Ethernet	N/A	N/A	1			
20	#							
21	#	ModbusDevice						
22	#	PortNo.	ModbusSl	ModuleNa	FunctionC	RegStartAc	RegCount	
23	*	0	1	ZT-2060	1	0	4	
24	*	0	1	ZT-2060	2	0	6	
25	*	0	2	ZT-2060	1	0	2	

◆ Support ZigBee Communication Protocol

ZT series module of ICP DAS includes a variety of ZigBee to Modbus Digital/Analog I/O modules, and also provides many ZigBee to RS-232/RS-485/Ethernet converter that can upgrade the normal Modbus devices to ZigBee wireless devices.

The advantages of ICP DAS's ZT series products are its ZigBee low cost, low power consumption features, FCC ID certification, and wireless communication capabilities up to 700 meters (Line of Sign, LOS) standard transmission distance, plus the dynamics mesh network that allows users to easily monitor Modbus device information in environments where cabling is not easy.

1.3. Specifications

MDC-211-ZT	
Radio Standard	
RF Channel	16
Antenna (2.4 GHz)	5 dBi Omni-Directional antenna
Transmit Power	11 dBm
Transmit Range (LOS)	700 m (Typical)
Ethernet Network	
Port	x1, 10/100 Base-TX
Protocol	Modbus TCP Slave
Serial port (COM)	
RS-232	x1, (TxD, RxD and GND)
RS-485	x1, (D+, D-)
Baud Rate	1200 ~ 115200 (bps)
Data Format	N81, N82, O71, O81, E71, E81, S71, S81, M71, M81
Protocol	Modbus RTU Master/Slave
Polling Definition	Up to 240 Modbus command definitions for all ZigBee/RS-232/ RS-485 ports
Shared Memory	9600 registers for each of AI, AO, DI and DO data
Institutions	
Casing	Metal
Dimensions (L x W x H)	120 mm x 33 mm x 116 mm
Installation	DIN-Rail
Power	
Protection	Power reverse polarity protection
EMS Protection	ESD, Surge, EFT
Required Supply Voltage	+10 V _{DC} ~ +30 V _{DC}
Power Consumption	5 W @ 24 V _{DC}
Environment	
Operating Temperature	-25°C ~ +75°C
Storage Temperature	-30°C ~ +80°C
Humidity	10~90% RH, Non-condensing

1.4. Size (Unit : mm)

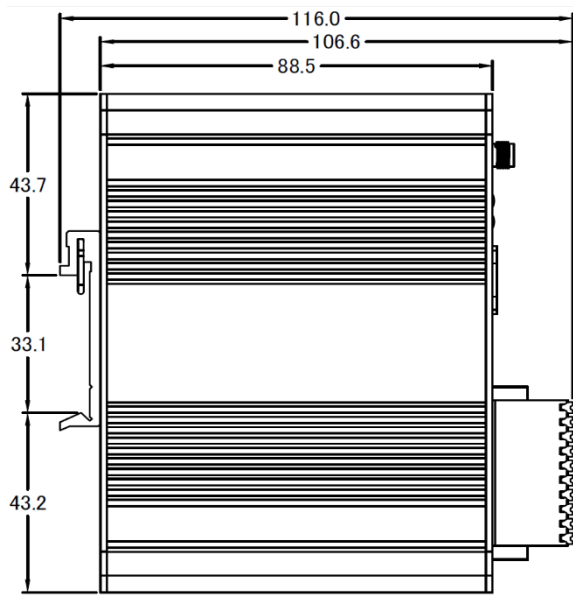

Left view

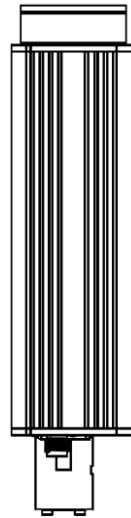

Top view

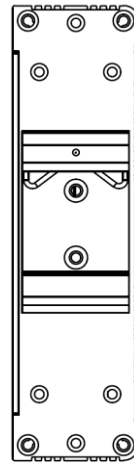

Post view

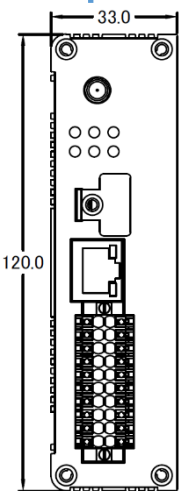
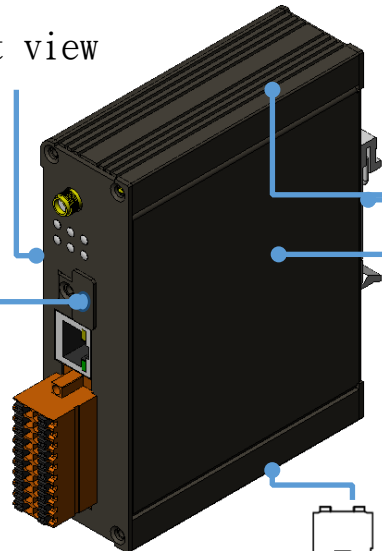

Front view

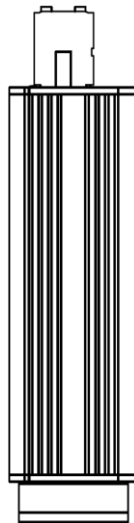

Bottom view

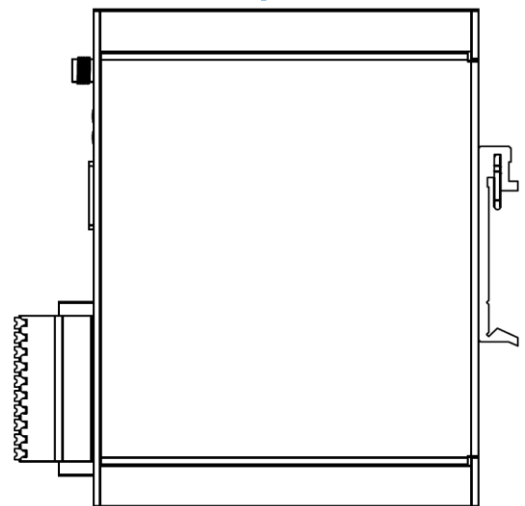

Right view

2. Getting Started With MDC-211-ZT

This chapter mainly describes the operation process of the MDC-211-ZT, such as, how to use the MDC-211-ZT Web interface via browser, and set up the Modbus Master and Modbus Slave function for the Modbus data concentrator.

◆ MDC-211-ZT Setting Flowchart

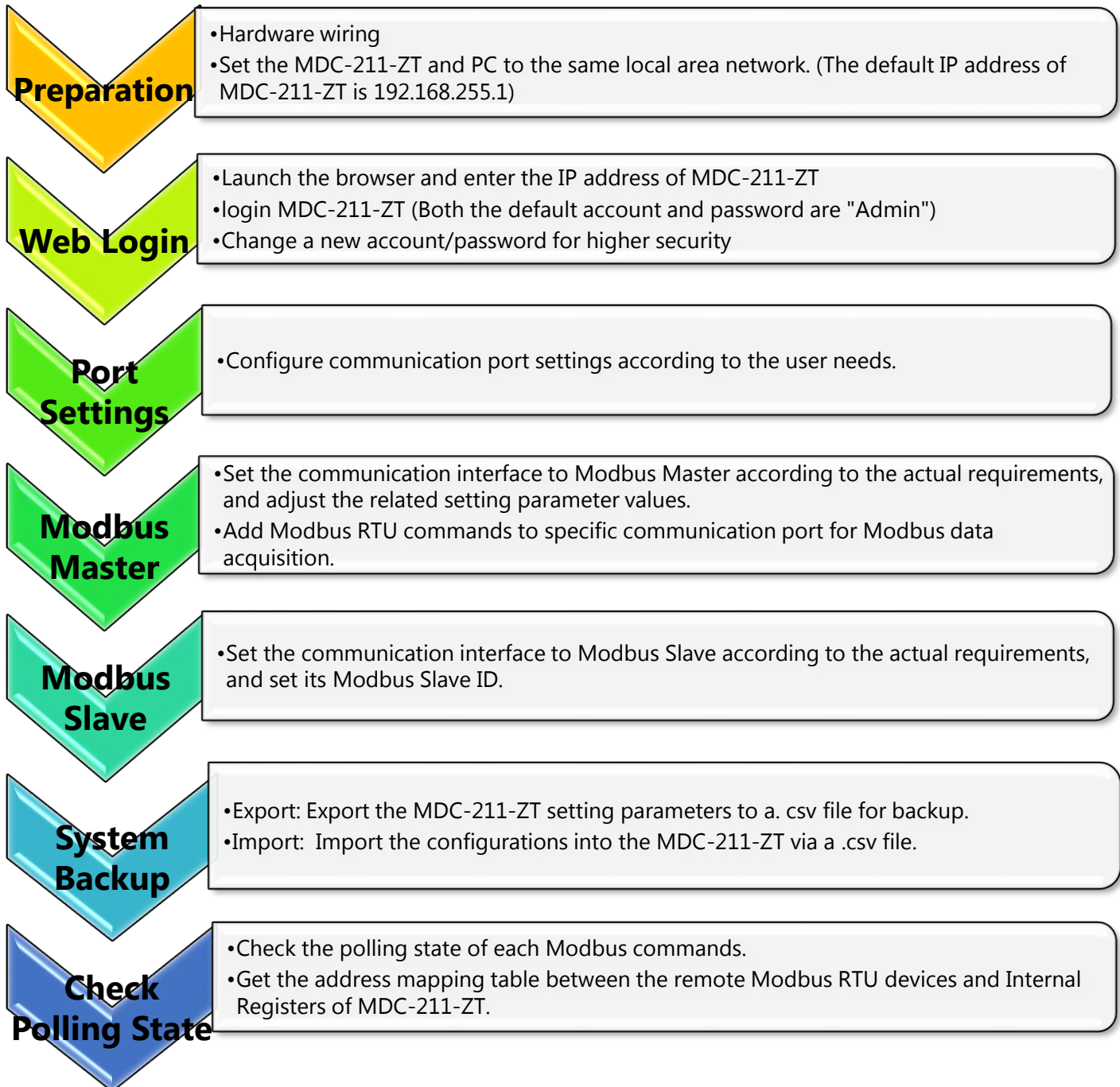

2.1. Preparation

Before setting up the MDC-211-ZT, please complete the necessary preparation, including hardware wiring, IP address settings, and so on, this section describes each.

◆ Hardware Wiring

Please follow Figure 2.1 wiring diagram, to wire the following items:

1. Power Supply : +10 VDC ~ +30 VDC
2. RS-485 : D+ & D-
3. RS-232 : TxD / RxD / GND
4. Ethernet : Connect the MDC-211-ZT and computer into the same LAN through cable or Ethernet Switch/Hub.

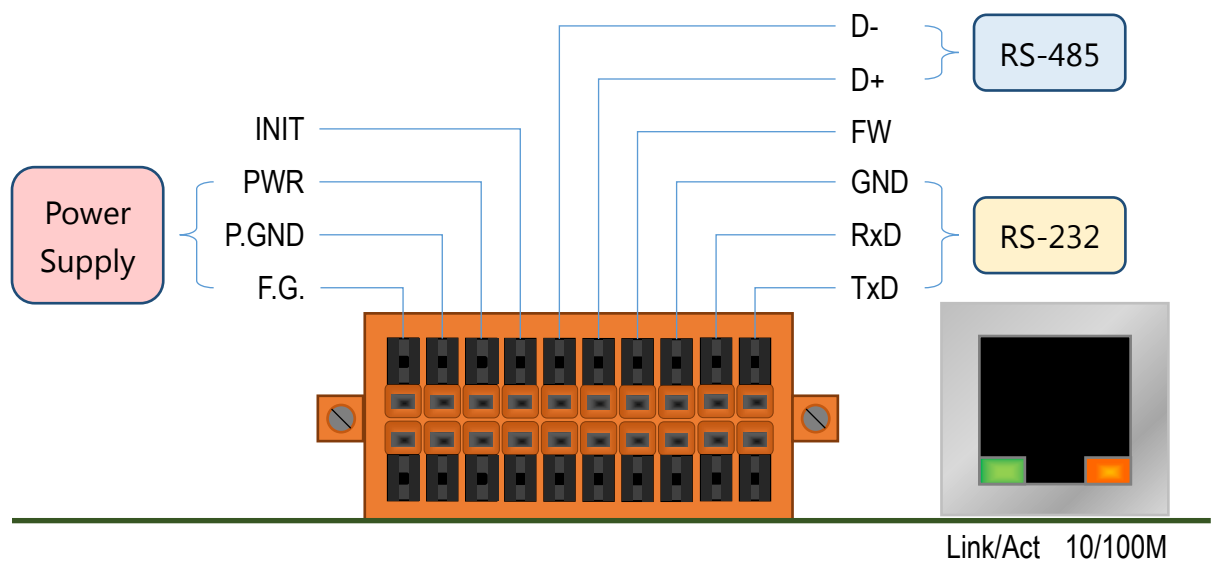

Figure 2.1 MDC-211-ZT Wiring Diagram

◆ Modifying IP address

Before connecting the MDC-211-ZT, please set the MDC-211-ZT to be the same LAN as the PC. Table 2.1 shows the default network setting of MDC-211-ZT. If it is in the different network area, please adjust network settings by the following software.



eSearch Utility software download link:

https://www.icpdas.com/tw/product/guide+Software+Utility_Driver+eSearch__Utility

Table 2.1 Factory default network settings of MDC-211-ZT

IP	192.168.255.1
Mask	255.255.0.0
Gateway	192.168.0.1

The following steps show how to modify the MDC-211-ZT network settings through eSearch Utility:

Steps 1 Click "Search Server" button to search for MDC-211-ZT module

Steps 2 Select "MDC-211-ZT", and click "Configuration (UDP)" button, as shown in Figure 2.2

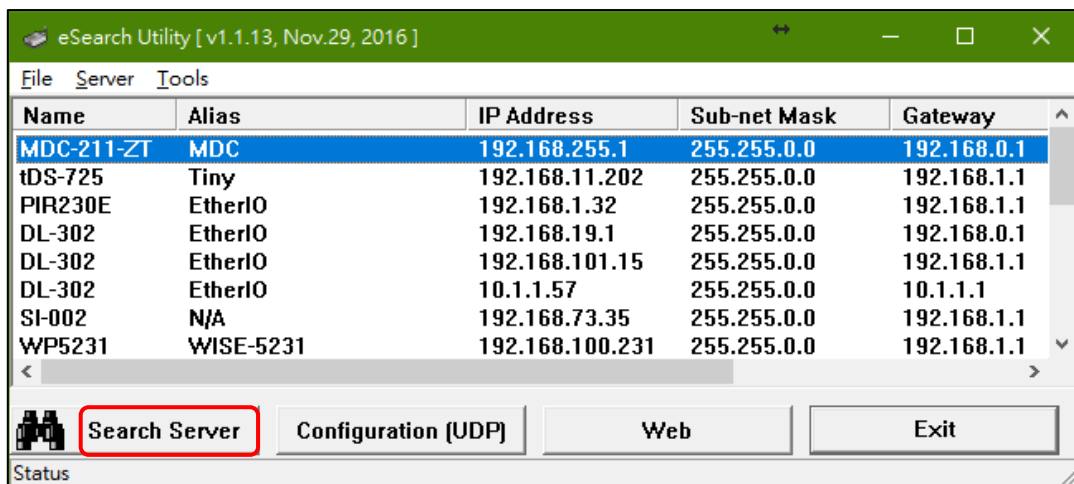

Diagram 2.2 eSearch Utility operator interfaces

Step 3 Configure the network parameters in the pop-up settings window, and click "OK" button to modify the network settings, as shown in Figure 2.3.

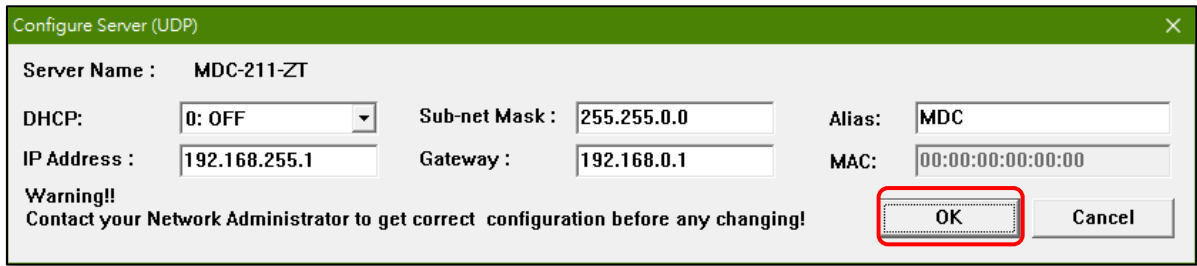

Figure. 2.3 Network parameter setting interface

Step 4 Finally, click "Search Server" button again to find the MDC-211-ZT module, to confirm that the network settings has been modified successfully.

2.2. Login MDC-211-ZT Web Interface

This section describes how to login the MDC-211-ZT Web interface.

Step1 Once the PC and MDC-211-ZT are in the same LAN, user can login the MDC-211-ZT by entering the IP address on Web browser (IE11/Chrome/Firefox, resolution 800 x 600 or more is recommended), the login screen is shown as Figure 2.4:

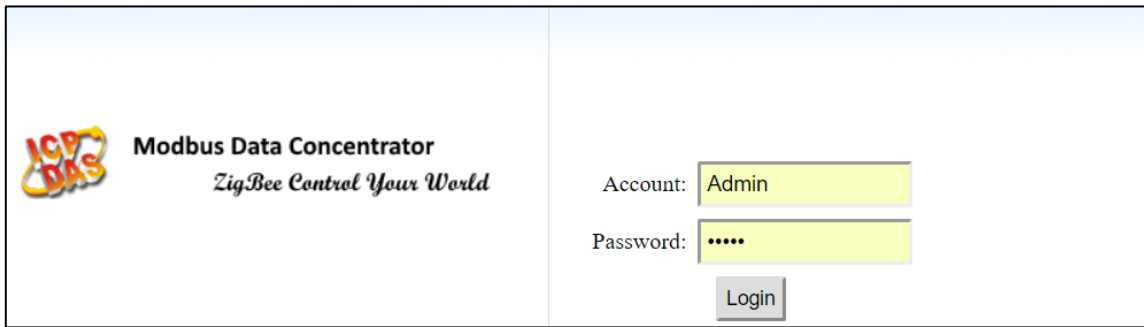

Figure 2.4 Product Login Page

Step2 Enter the account and password for the MDC-211-ZT Web page (case-insensitive) and click the "Login" button.

- Default Account : Admin
- Default Password : Admin

Step3 Click "System Information" → "Account Management" to modify account and password for higher security, as shown in Figure 2.5

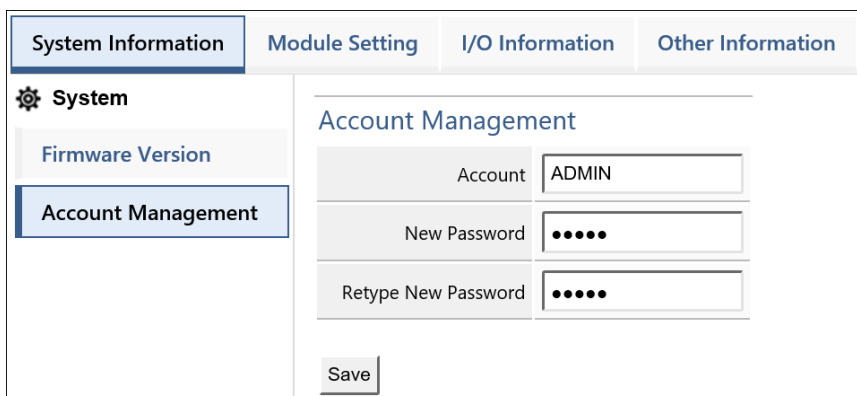

Figure 2.5 Account Management

2.3. Set Port Information

MDC-211-ZT provides one port ZigBee, one port Ethernet, one port RS-232 and one port RS-485 communication interface, this section introduces the configuration procedure for these communication interface.

◆ ZigBee Port Setting

Click "Module Setting" → "ZigBee", to read the current ZigBee setting parameters, if user want to adjust the ZigBee settings, click the "Modify" button to switch to the configuration page, as shown in Figure 2.6.

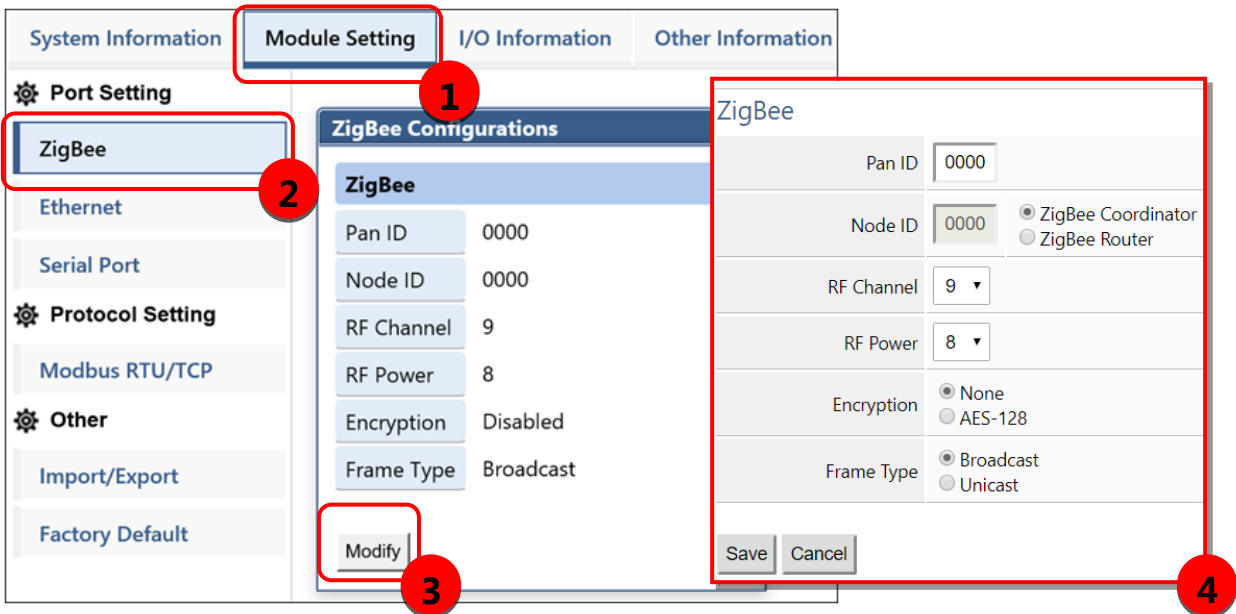

Figure 2.6 Steps to switch to the ZigBee configuration page

For the description of the ZigBee settings, please refer to section "4.1.1 ZigBee Communication Interface". After modifying the setting parameters, please remember to click "Save" button to save the changes, or click the "Cancel" button to discard the configuration and return to the previous page.

NOTE - The new ZigBee settings will take effect immediately after configuration without restarting the power of the MDC-211-ZT.

◆ Ethernet Port Setting

Click "Module Setting" → "Ethernet", to read the current Ethernet setting parameters, if user want to adjust the Ethernet settings, click the "Modify" button to switch to the configuration page, as shown in Figure 2.7.

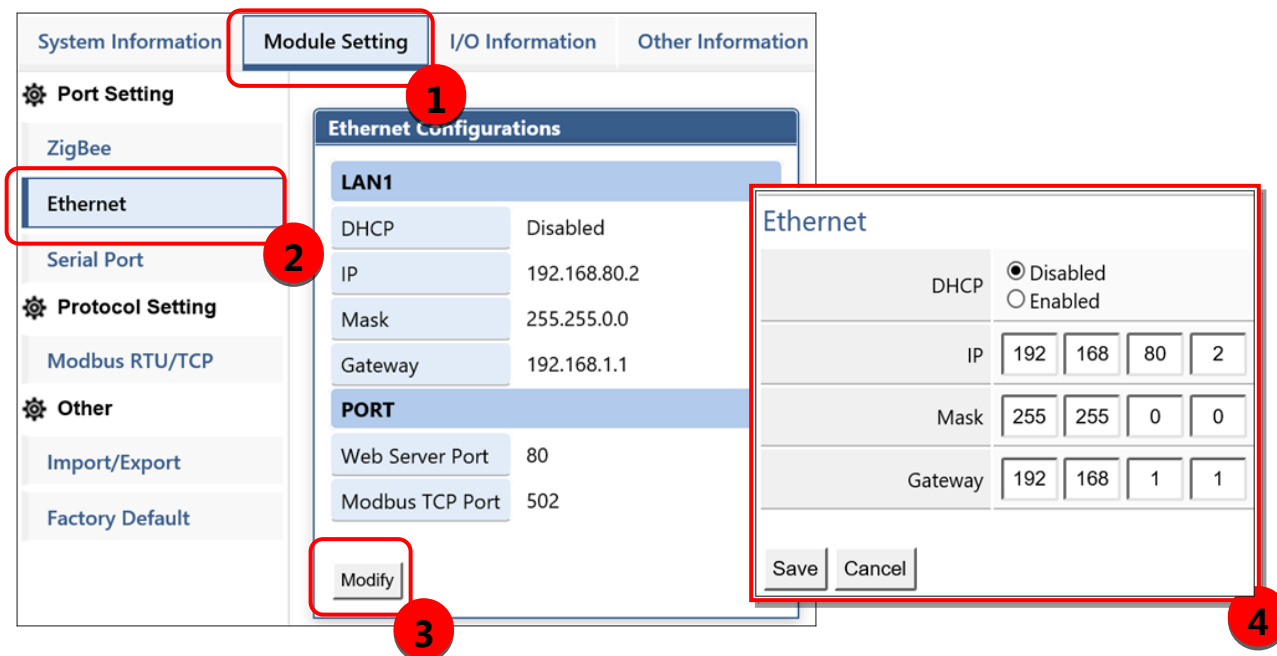

Figure 2.7 Steps to switch to the Ethernet configuration page

After modifying the setting parameters, please remember to click "Save" button to save the changes, or click the "Cancel" button to discard the configuration and return to the previous page.

NOTE - The new Ethernet settings only take effect after restarting the power of the MDC-211-ZT.

◆ Serial Port Setting

Click "Module Setting" → "Serial Port", to read the current RS-232 and RS-485 setting parameters, if user want to adjust the configurations of Serial Port, click the "Modify" button to switch to the configuration page, as shown in Figure 2.8.

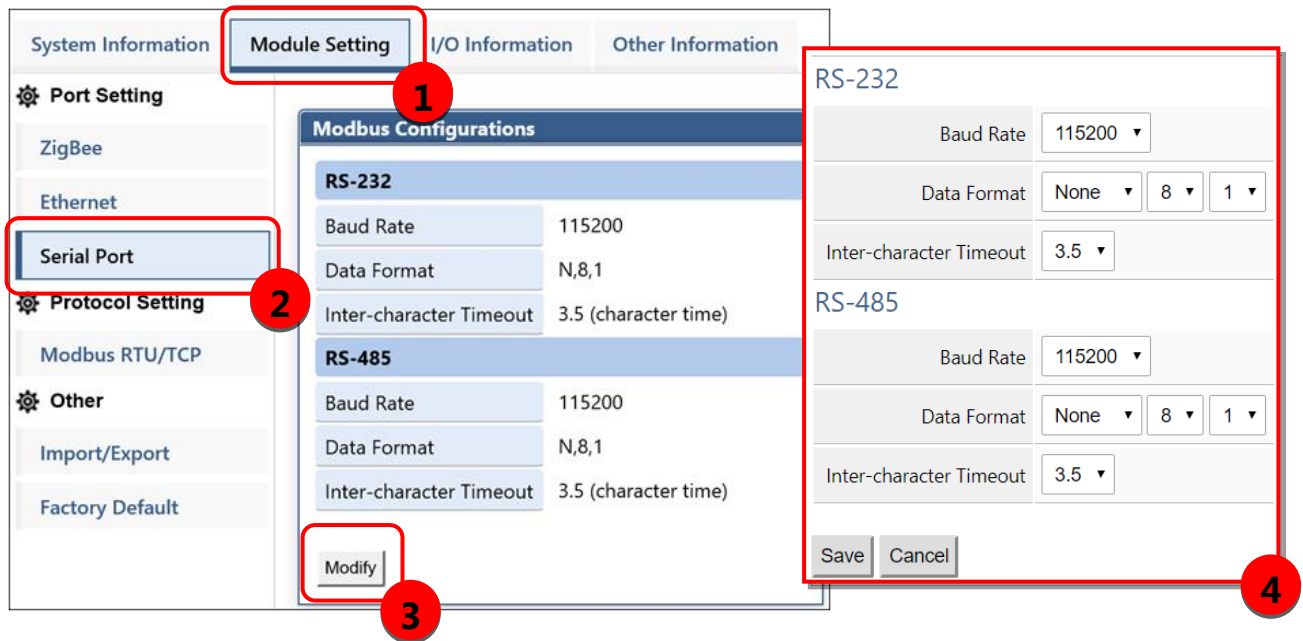

Figure 2.8 Steps to switch to the Serial Port configuration page

For the description of the Serial Port settings, please refer to section "4.1.2 Serial Port Communication Interface". After modifying the setting parameters, please remember to click "Save" button to save the changes, or click the "Cancel" button to discard the configuration and return to the previous page.

NOTE - The new Serial Port settings will take effect immediately after configuration without restarting the power of the MDC-211-ZT.

2.4. Set MDC-211-ZT as Modbus Master

Each ZigBee/RS-232/RS-485 communication interface on MDC-211-ZT can be either set as Modbus Master or Modbus Slave. This section describes how to set the communication interface as the Modbus Master, and add the Modbus RTU devices to be monitored.

◆ Read current Modbus protocol setting values

Click "Module Setting" → "Modbus RTU/TCP", to read the current setting parameters of the Modbus RTU/TCP protocol for each communication interface, if user want to modify these configurations, click the "Modify" button to switch to the configuration page, as shown in Figure 2.9.

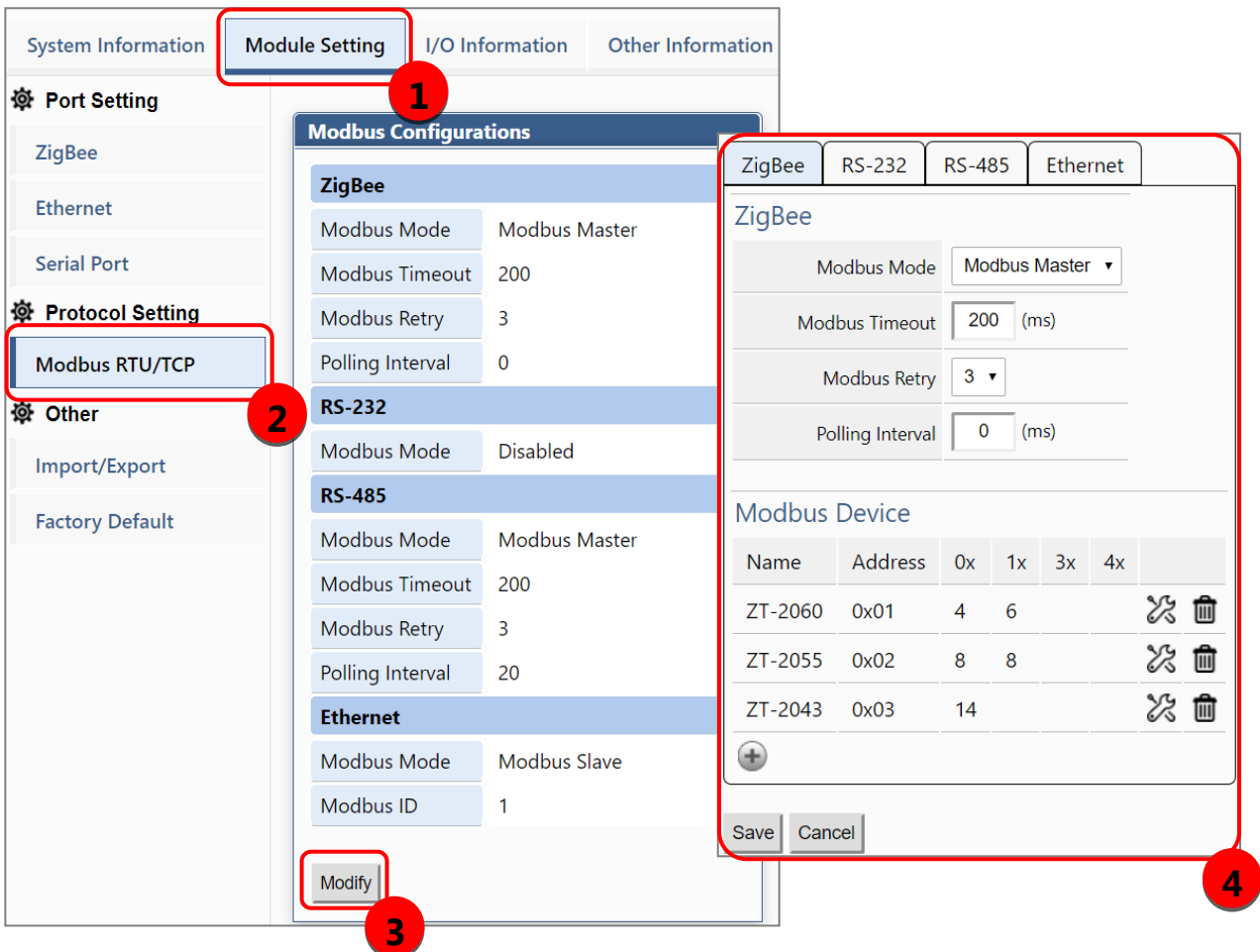

Figure 2.9 Steps to switch to the Modbus protocol configuration page

◆ **Set the specified communication interface as Modbus Master**

Click the "Module Setting" → "Modbus RTU/TCP" → "ZigBee/RS-232/RS-485", to select the to "Modbus Master" in the "Modbus Mode" configuration field. For the description of the Modbus Communication Interface settings, please refer to section "4.2 Modbus Protocol Parameter Descriptions".

◆ **Add the Modbus RTU devices that want to control**

Step1 After setting the protocol to Modbus Master (refer to Figure 2.9), click the icon " + " at the bottom of "Modbus Device" to add a Modbus RTU Slave device and give the module name (up to 12 ASCII characters) and Modbus address (the Slave station number (1~255) of the Modbus RTU).

Step2 Following the Figure 2.10, click the icon " + " at the bottom of Modbus RTU Slave module to add a Modbus RTU Register, and set the Modbus Function Code, Start address, Length and Range of the Register.

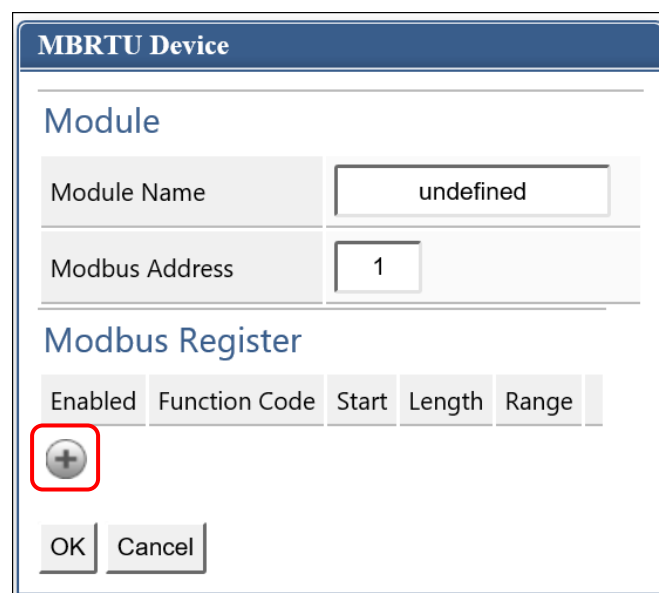

Figure 2.10 Add Modbus RTU Slave Module/Register window

Step3 After settings, click "OK" for saving the changes. If you want to discard the changes please click "Cancel" go back to the previous page. If you want to remove the Modbus register, click the icon "🗑️".

2.5. Set MDC-211-ZT as Modbus Slave

One of the MDC-211-ZT ZigBee/RS-232/RS-485 ports can be set as Modbus Master or Modbus Slave (Ethernet port can only be used as Modbus Slave). This section describes how to set the communication interface as Modbus Slave.

◆ Set communication interface to Modbus Slave

Click "Module Setting" → "Modbus RTU/TCP" → click "Modify" → Select the one of the " ZigBee / RS-232 / RS-485" and set "Modbus Status" as Modbus Slave. Finally, set the station number (1~255) of MDC-211-ZT as the Modbus Slave.

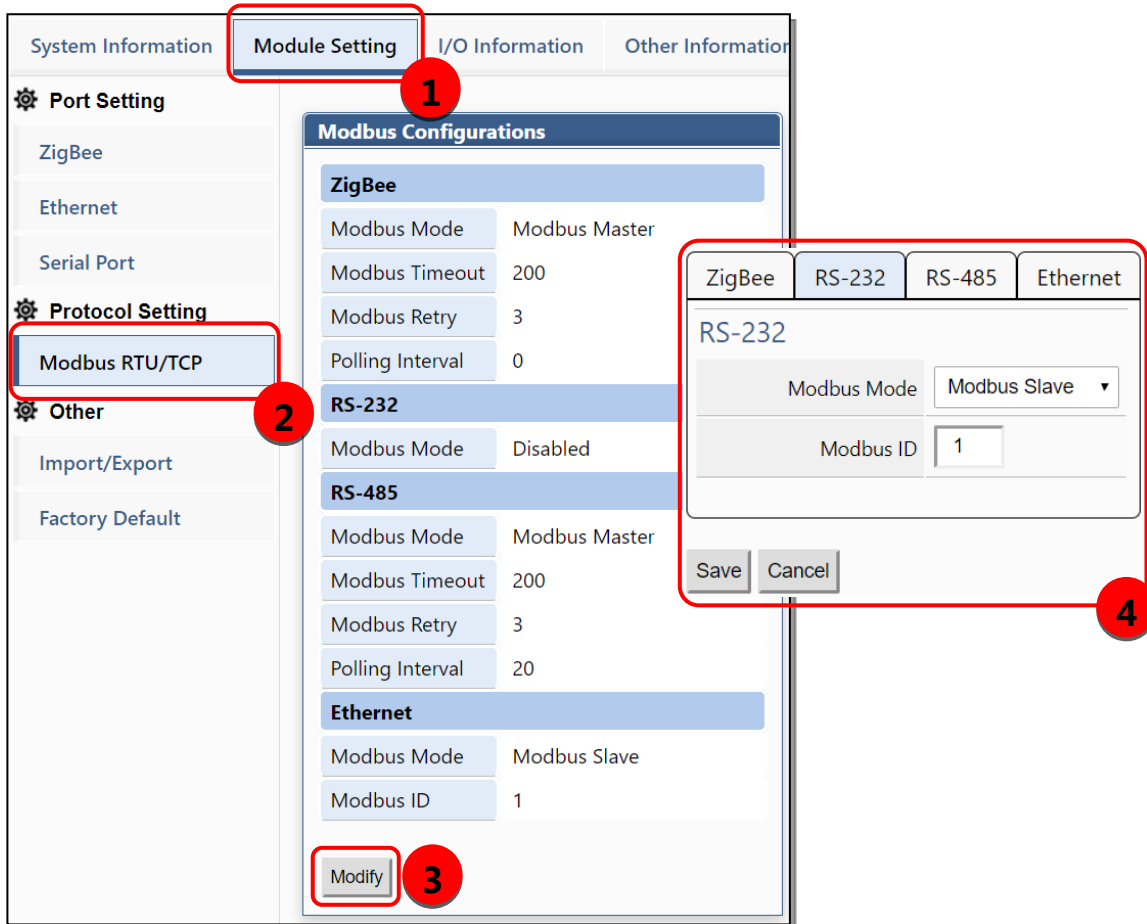

Figure 2.11 Modbus RTU/TCP Protocol parameter setting page

◆ **Modbus Internal Register Address of MDC-211-ZT**

When MDC-211-ZT as Modbus Slave, the external controller can indirectly read the data of the Modbus RTU devices, for its corresponding Modbus Register information, refer to "2.6.2 Inquire Modbus Inner- register address of the corresponding relationship".

2.6. Check Modbus RTU Device Communication Status

The user can view and monitor the status of each Modbus command directly on the MDC-211-ZT Web interface. This section describes how to check the Modbus command status, real-time monitor the I/O channel status of Modbus RTU device, and inquire the relationship for the Modbus RTU device I/O and the MDC-211-ZT Internal Register address.

2.6.1. Check polling status of Modbus command

Click "I/O Information" → "Internal Register", the browser will load the Modbus command real-time information as Figure 2.12, the descriptions please see Table 2.2.

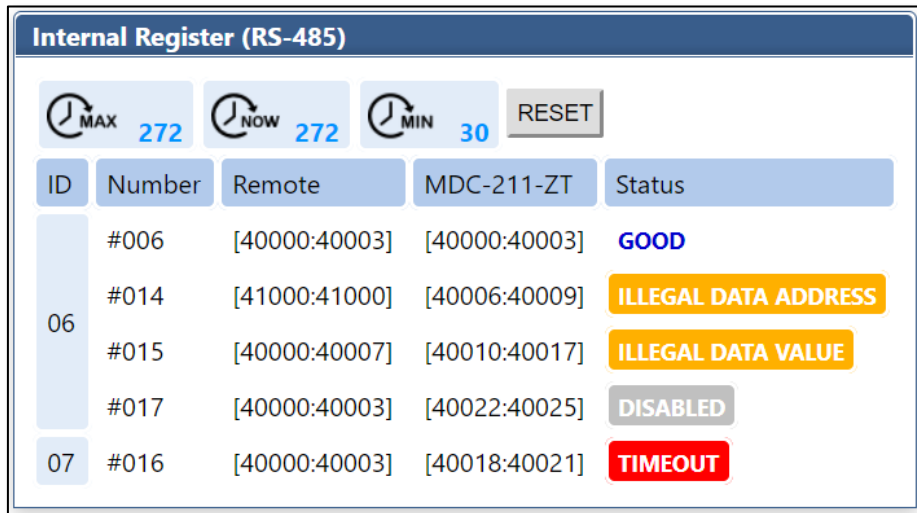

Figure 2.12 Modbus Command Communication real-time Status page

Table 2.2 I/O information real-time display description

Item	Description
ID	Modbus RTU Slave Module Station number
Number	MDC-211-ZT Modbus Command Polling order and corresponding Internal Register order
Remote	Modbus RTU Slave Module Register address
MDC-211-ZT	MDC-211-ZT Internal Register address
Status	Modbus Command Polling status

If want to inquire the Modbus command communication status between MDC-211-ZT and Modbus RTU devices, please refer to the "Status" item:

- (1) If the "Status" item displays **GOOD**, means the command is connected and reading data currently.
- (2) If the "Status" item displays **DISABLED**, means the command was disabled by the user.
- (3) If the "Status" item displays **TIMEOUT**, means the command was timeout and the device did not respond, please check the module wiring, and the following Modbus RTU device settings those need to be consistent with the settings in MDC-211-ZT.
 - Baud Rate
 - Data Format (Data Bit / Parity / Stop Bit)
 - Station number (ID) of the Modbus RTU Slave device
- (4) If the "Status" item displays **ILLEGAL DATA FUNCTION**, represents Modbus Exception code 01, which means the command connection was established, but the Modbus RTU device of the communication target does not support the function code, please recheck the Modbus command parameters.
- (5) If the "Status" item displays **ILLEGAL DATA ADDRESS**, represents Modbus Exception Code 02, which means the command connection was established, but the Modbus RTU device of the communication target does not support the Starting Register address, or exceeds the legal Register range (Starting + Length) , please recheck the Modbus command parameters.
- (6) If the "Status" item displays **ILLEGAL DATA VALUE**, represents Modbus Exception Code 03, means the command connection was established, but the Quantity of the command access Register is not valid, please recheck the Modbus command parameters.
- (7) If the "Status" item displays **CRC ERROR**, means the Modbus CRC code error and the communication may be disturbed abnormally.

2.6.2. Inquire Corresponding Modbus Register Address

When the users define a Modbus command, MDC-211-ZT automatically generates the corresponding Internal Register address according to the order of the Modbus command. The users only need to select "I/O Information" → "Internal Register", the browser will automatically load the Modbus Register mapping table.

Table 2.3 Modbus Command Definition Example

#	PortNo.	ModbusSlaveID	ModuleName	FunctionCode	RegStartAddr	RegCount
*	0	1	ZT-2060	1	0	4
*	0	1	ZT-2060	2	0	6
*	0	2	ZT-2060	1	0	4
*	0	2	ZT-2060	2	0	6
*	0	3	ZT-2043	1	0	14
#						

For example of the table 2.3 above, the browser will load the Modbus Register mapping table as Figure 2.13. The "Remote" item in the mapping table represents the Register address of the Modbus RTU device; the "MDC-211-ZT" item represents the corresponding Internal Register address. The users can access Internal Register address in the "MDC-211-ZT" item via the Modbus protocol to control the entity Modbus RTU device.

ID	Number	Remote	MDC-211-ZT	Status
01	#001	[00000:00003]	[00000:00003]	GOOD
	#002	[10000:10005]	[10000:10005]	GOOD
02	#003	[00000:00003]	[00004:00007]	GOOD
	#004	[10000:10005]	[10006:10011]	GOOD
03	#005	[00000:00013]	[00008:00021]	GOOD

Figure 2.13 Modbus Register Mapping Table in Web Interface

2.6.3. Testing I/O Channel Status of Modbus RTU Device

MDC-211-ZT can real-time control the I/O channel of Modbus RTU devices via the standard Modbus protocol, and also provide Web UI to real-time control the Modbus I/O channel status. As Figure 2.14, users only need to click "I/O Information" and select the Modbus RTU device want to control, the Web UI will display the pre-set Modbus command and real-time display that Modbus device I/O channel status. The user can directly click I/O channel to change the I/O channel status.

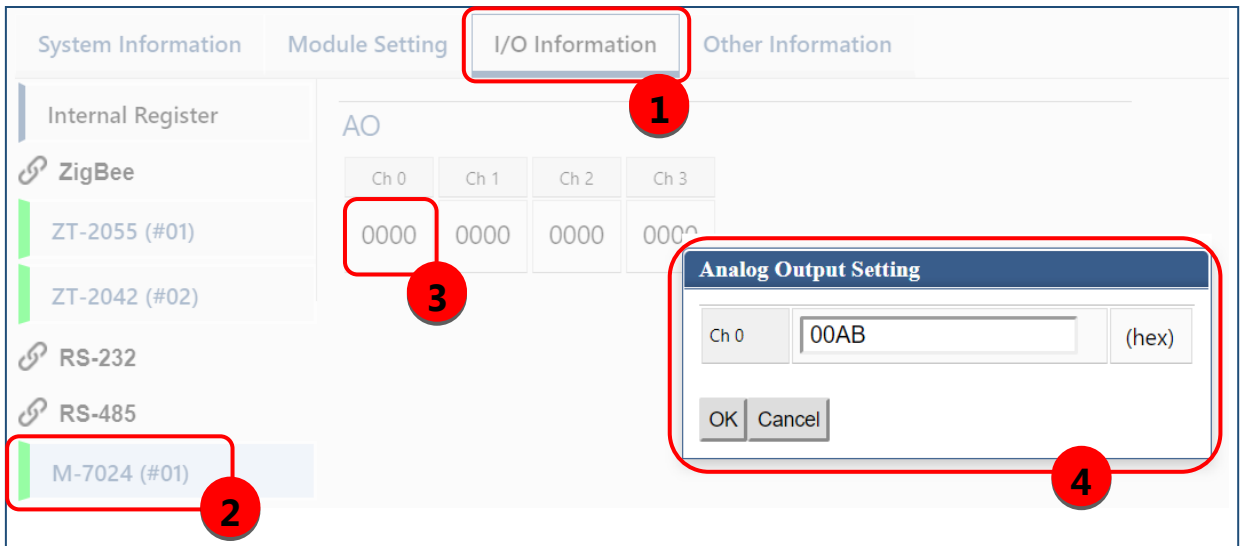
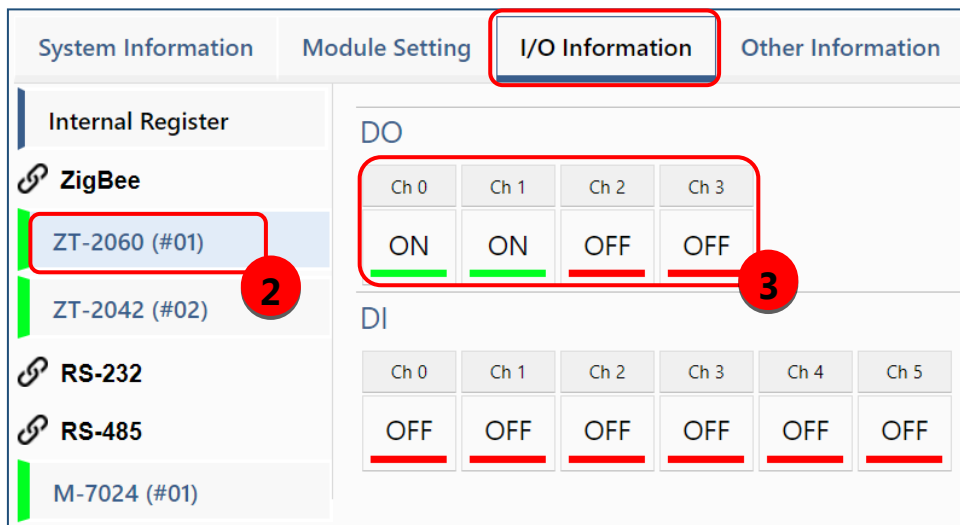

Figure 2.14 Modbus I/O information real-time display page

3. Export and Import the System Settings

The user can set up MDC-211-ZT via the Web UI, and also can export the configuration to a *.csv file in the local computer for backup. More, the user can directly edit the setting parameters in a *.csv file and import the *.csv file into the MDC-211-ZT module to complete the module setting.

This chapter introduces how to export and import the *.csv file, and describes the format and setting code for the *.csv file, and some setting recommendations.

NOTE - *.csv file is a text file format that can be edited in spreadsheet software or plain text files and has the advantage of being easy to use, read and maintain. It uses commas "," to separate each column in a plain-text editor.

3.1. Export and Import the Configurations

This section describes the process to import and export the module configuration.

◆ Export

As Figure 3.1, select "Module Setting" → "Import/Export" → "Export" to export the configurations of MDC-211-ZT to a *.csv file.

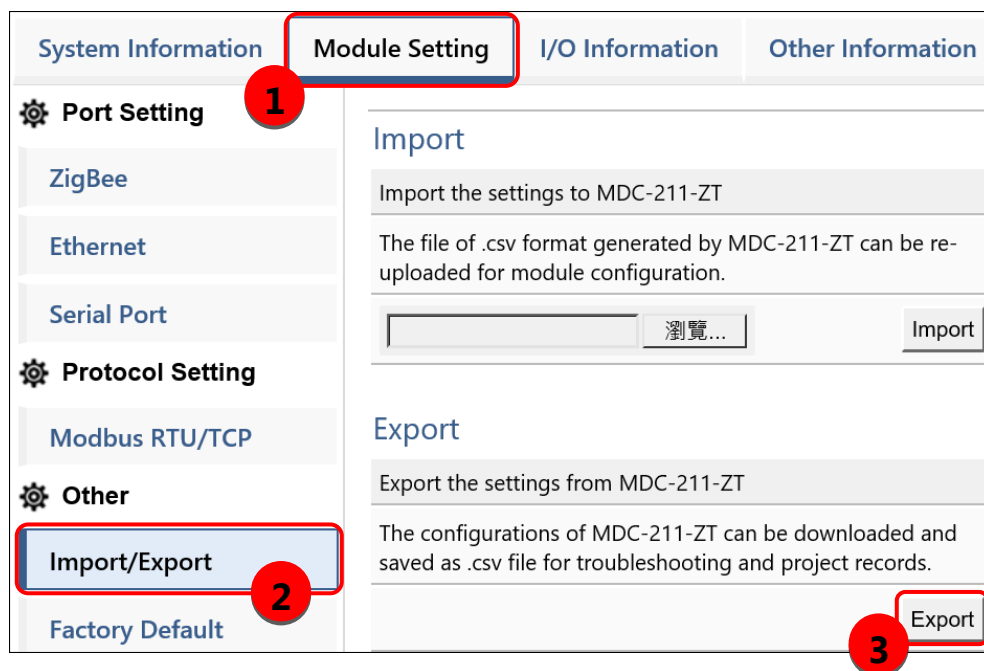

Figure 3.1 Module Setting Export page

◆ Import

As Figure 3.2, click "Module Setting" → "Import/Export" → "Choose file" → "Import", then the *.csv file can be uploaded into MDC-211-ZT and set up immediately.

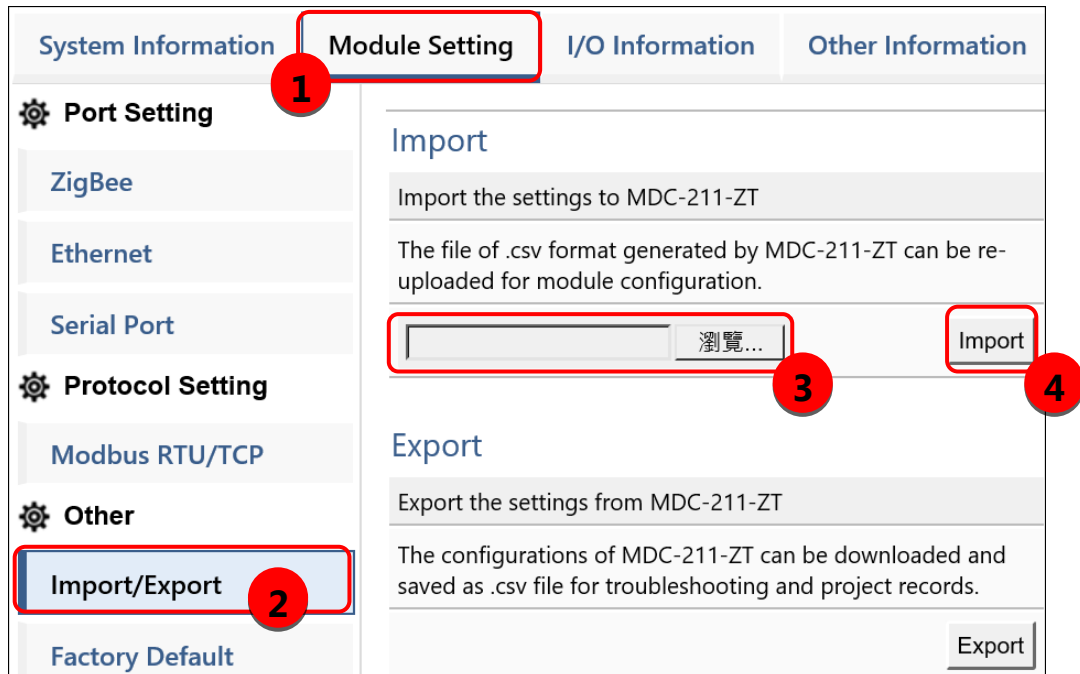

Figure 3.2 Module Setting Import page

3.2. Format Descriptions for the Configuration File (*.csv)

If the user wants to set up MDC-211-ZT through the *.csv configuration file, the user can export a *.csv file from the Web Interface as the configuration template. For the detail steps, please refer to "3.1 Export and Import the Configurations".

The MDC-211-ZT configuration file includes all setting parameters. The label name and order must be the same as the example in Figure 3.3. Below will introduce the settings of ZigBee, Serial port and Ethernet, and the settings for Modbus Master and Modbus Slave.

NOTE - *.csv template can be got via the MDC-211-ZT Web Interface (refer to Section 3.1).

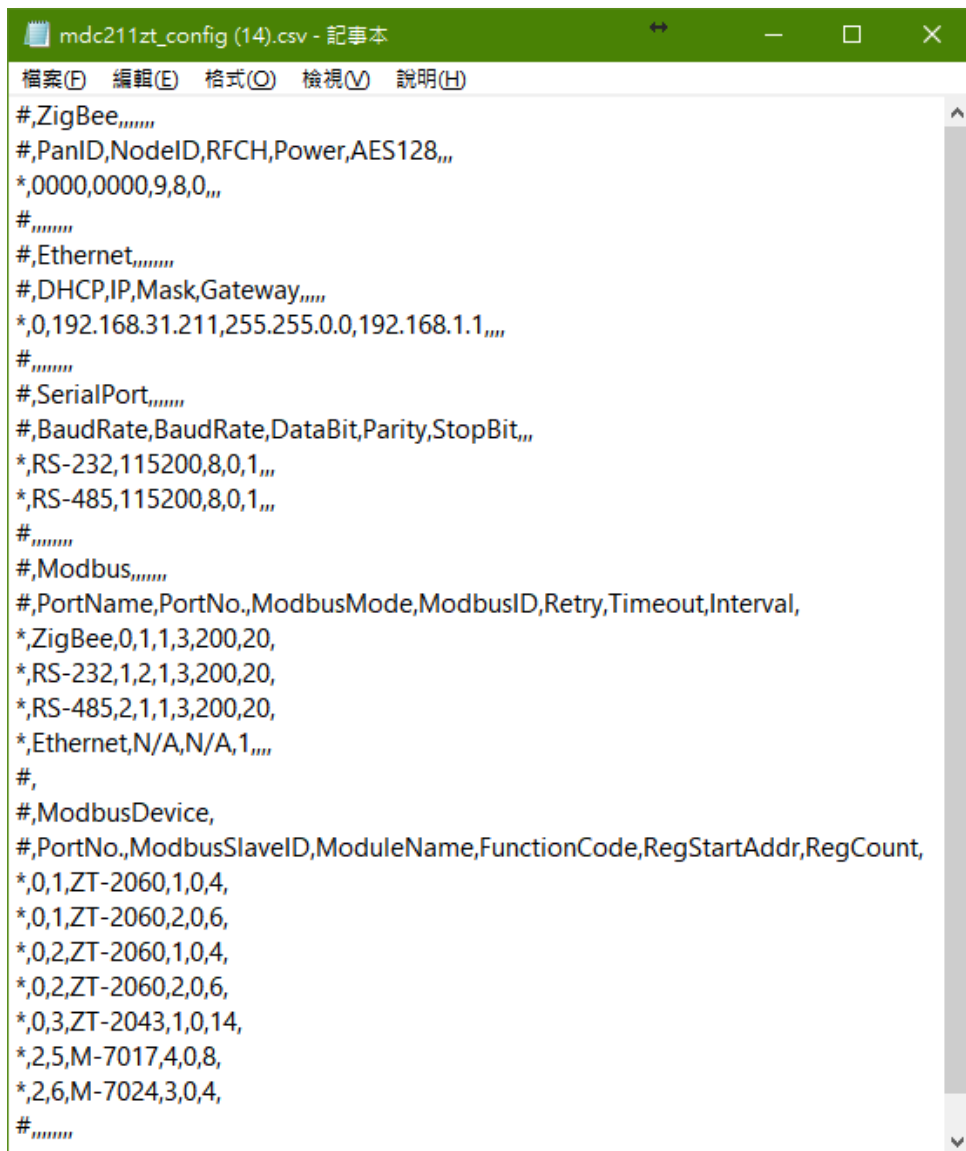

```
mdc211zt_config (14).csv - 記事本
檔案(F) 編輯(E) 格式(O) 檢視(V) 說明(H)
#,ZigBee,,,,,,
#,PanID,NodeID,RFCH,Power,AES128,,,
*,0000,0000,9,8,0,,,
#,,,,,,
#,Ethernet,,,,,,
#,DHCP,IP,Mask,Gateway,,,,
*,0,192.168.31.211,255.255.0.0,192.168.1.1,,,
#,,,,,,
#,SerialPort,,,,,,
#,BaudRate,BaudRate,DataBit,Parity,StopBit,,,
*,RS-232,115200,8,0,1,,,
*,RS-485,115200,8,0,1,,,
#,,,,,,
#,Modbus,,,,,,
#,PortName,PortNo.,ModbusMode,ModbusID,Retry,Timeout,Interval,
*,ZigBee,0,1,1,3,200,20,
*,RS-232,1,2,1,3,200,20,
*,RS-485,2,1,1,3,200,20,
*,Ethernet,N/A,N/A,1,,,
#,
#,ModbusDevice,
#,PortNo.,ModbusSlaveID,ModuleName,FunctionCode,RegStartAddr,RegCount,
*,0,1,ZT-2060,1,0,4,
*,0,1,ZT-2060,2,0,6,
*,0,2,ZT-2060,1,0,4,
*,0,2,ZT-2060,2,0,6,
*,0,3,ZT-2043,1,0,14,
*,2,5,M-7017,4,0,8,
*,2,6,M-7024,3,0,4,
#,,,,,,
```

Figure 3.3 MDC-211-ZT configuration file (*.csv)

◆ ZigBee Communication Settings

The first part is for ZigBee settings. ZigBee parameter descriptions may refer to "4.1.1 ZigBee Communication Interface", the label name and setting descriptions see Table 3.1 below.

#	ZigBee					
#	PanID	NodeID	RFCH	Power	AES128	FrameType
*	0	0	9	8	0	0
#						

Table 3.1 ZigBee settings and descriptions

Item	Label Name	Valid Code & Range
Pan ID	<i>PanID</i>	0000 ~ 3FFF
Node ID	<i>NodeID</i>	Coordinator: 0000 Router: 0001 ~ FFF7
RF Channel	<i>RFCH</i>	0 (2405 MHz) ~ F (2480 MHz)
RF Power	<i>Power</i>	0 (min.) ~ F (max.); default 8 (compatible with the CE/FCC specification limitation)
Encryption	<i>AES128</i>	0 (Disable)/1 (Enable)
Frame Type	<i>FrameType</i>	0 (Broadcast)/1 (Unicast)

◆ Ethernet Communication Settings

The second part is for Ethernet settings. Ethernet label name and setting descriptions please see table 3.2 below.

#	Ethernet			
#	DHCP	IP	Mask	Gateway
*	0	192.168.255.1	255.255.0.0	192.168.0.1
#				

Table 3.2 Ethernet settings and descriptions

Item	Label Name	Valid Code & Range
DHCP	<i>DHCP</i>	0 (Disable) / 1 (Enable)

NOTE – The IP, Mask and Gateway should be set up according to the local network.

◆ Serial Port Communication Settings

The third part is for Serial port settings. Serial port parameter descriptions may refer to "4.1.2 Serial Port Communication Interface", the label name and setting descriptions please see table 3.3 below.

#	SerialPort					
#	PortName	BaudRate	DataBit	Parity	StopBit	CharTime
*	RS-232	115200	8	0	1	3.5
*	RS-485	115200	8	0	1	3.5
#						

Table 3.3 Serial port settings and descriptions

Item	Label Name	Note
Port Name	<i>PortName</i>	The name of the Serial port; the location and content are unmodifiable.
Baud Rate	<i>BaudRate</i>	115200 / 57600 / 38400 / 19200 / 9600 / 4800 / 2400 / 1200 (Unit: bps)
Data Format	<i>DataBit</i>	7 / 8
	<i>Parity</i>	0 (None) / 1 (Odd) / 2 (Even) / 3 (Mark) / 4 (Space)
	<i>StopBit</i>	0 / 1 / 2
Inter-character Timeout	<i>CharTime</i>	1.5 ~ 10 (Unit: Character Time)

◆ Modbus Mode Settings

The fourth part is for Modbus mode settings. Modbus parameter descriptions may refer to Section 4.2, the label name and setting descriptions please see Table 3.4 below.

#	Modbus						
#	PortName	PortNo.	ModbusMode	ModbusID	Retry	Timeout	Interval
*	<i>ZigBee</i>	0	1	1	3	200	30
*	<i>RS-232</i>	1	0	1	3	150	0
*	<i>RS-485</i>	2	1	1	3	150	20
*	<i>Ethernet</i>	N/A	N/A	1			
#							

Table 3.4 Modbus protocol settings and descriptions

Item	Label Name	Note
Port Name	<i>PortName</i>	The name of the Modbus communication port; the location and content are unmodifiable.
Port Number	<i>PortNo.</i>	The number of the Modbus communication port; the location and content are unmodifiable.
Modbus Mode	<i>ModbusMode</i>	0 (Disable) / 1 (Modbus Master) / 2 (Modbus Slave) Ethernet fixed to Modbus Slave, no need to set
Modbus Retry	<i>Retry</i>	0 ~ 9
Modbus Timeout	<i>Timeout</i>	0 ~ 65535
Polling Interval	<i>Interval</i>	0 ~ 65535

◆ Modbus Command Settings

The fifth part is for Modbus command settings. The label name and setting descriptions please see Table 3.5 below.

#	ModbusCommand					
#	PortNo.	ModbusSlaveID	ModuleName	FunctionCode	RegStartAddr	RegCount
*	0	1	ZT-2060	1	0	4
*	0	1	ZT-2060	2	0	6
-	0	2	ZT-2043	1	0	14
*	2	1	M-7017	4	0	8
*	2	2	M-7024	3	0	4
#						

Table 3.5 Modbus RTU device settings and descriptions

Item	Label Name	Note
Port Number	<i>PortNo.</i>	0 (ZigBee) / 1 (RS-232) / 2 (RS-485)
Modbus Slave ID	<i>ModbusSlaveID</i>	1 ~ 255
Module Name	<i>ModuleName</i>	Up to 12 ASCII characters
Function Code	<i>FunctionCode</i>	1 (Read/Write DO) / 2 (Read DI) / 3 (Read/Write AO) / 4 (Read AI)
Starting Address	<i>RegStartAddr</i>	0 ~ 65535
Quantity of Register	<i>RegCount</i>	1 ~ 64

[Note] The first column of the *.csv file has different meanings. It marks as:

"#": means the system-defined label; do not change the name and location (order).

"*": means the data that the user enabled.

"-": means the data that the user does not enable.

4. Parameter Descriptions

This chapter introduces a variety of setting parameters and examples for the users to follow and set up the modules.

4.1. Communication Interface Parameter Descriptions

4.1.1. ZigBee Communication Interface

◆ Parameter descriptions

Table 4.1 shows the descriptions for the ZigBee parameters, setting range and notes.

Table 4.1 ZigBee related parameter descriptions

Item	Description	Note
Pan ID	ZigBee	Setting range: 0x0000 ~ 0x3FFF
	Network ID	Must set the same Pan ID in the same domain network
Node ID	ZigBee	Coordinator/Host: Fixed to 0x0000 Router/Slave: setting range within 0x0001 ~ 0xFFFF7
	Node ID	No duplicate node number under the same domain network
RF Channel	Radio Frequency	Setting range: 0 ~ F (2405~2480 MHz)
	Channel	Must set to the same if in the same domain network
RF Power	Transmit Power	Signal strength from small to large: 0~F. Factory default: 8 (Compatible with the FCC specification limitation)
		This parameter is only for testing purposes. If the users change it that is a personal behavior, the ICP DAS cannot guarantee that the user-changed parameter is still compatible with the FCC specification limitation, and ICP DAS assumes no legal liability for any damage resulting from the change of the parameter.
Encryption (AES 128)	Communication Encryption	Enable or disable
		Must set to the same if in the same domain network

Frame Type	ZigBee Frame Type	Broadcast or unicast
		Only the ZigBee coordinator need to be set

The "Frame Type" parameter in Table 4.1 is the packet type for the wireless data transmission. In general, please select "Broadcast"; but in some case of the communication range is small and the number of nodes is large, select the "Unicast" can reduce the data traffic of the ZigBee wireless network and thus improve communication efficiency, as shown in Figure 4.1.

Note 4.1: If using ZT-2551/ZT-2571 modules to connect Modbus RTU devices in the ZigBee network, be sure to set the "Frame Type" parameter of MDC-211-ZT to "Broadcast".

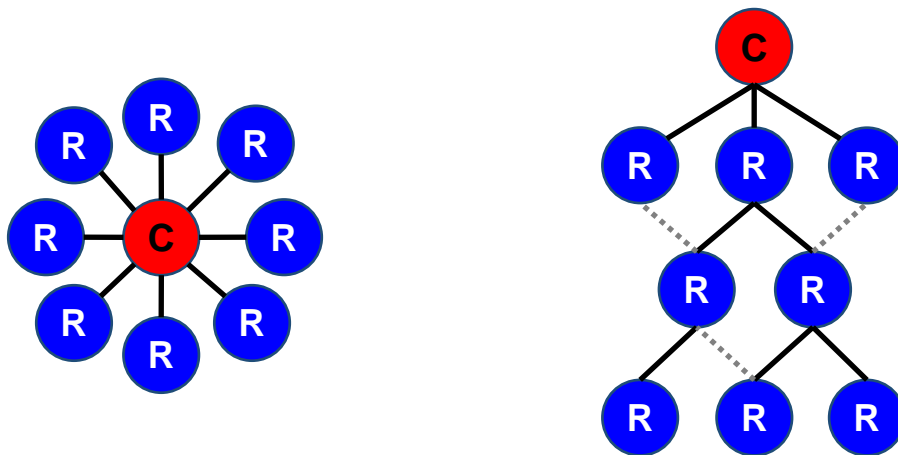

Figure 4.1 The star topology on the left figure is suitable to use the unicast packet; the tree/mesh topology on the right figure is suitable to use the broadcast packet.

◆ Example

The following table is a setting example to set the MDC-211-ZT as a ZigBee coordinator, and recommend the parameter values for the ZT-2000 series module. For the detail setting of ZT-2000 series module, please refer to its user manual.

Table 4.2 MDC-211-ZT and ZT-2551/ZT-2571 example

Item	MDC-211-ZT	ZT-2551 ZT-2571	ZT-2055	ZT-2060
Pan ID	0x0000			
Node ID	0x0000	0x0001	0x0002	0x0003
RF Channel	0x09			
RF Power	0x08	0x08	0x08	0x08
Encryption (AES 128)	Disabled	Disabled	Auto	Auto
Frame Type	Broadcast	N/A	N/A	N/A
Application Mode	N/A	Transparent	Modbus	Modbus

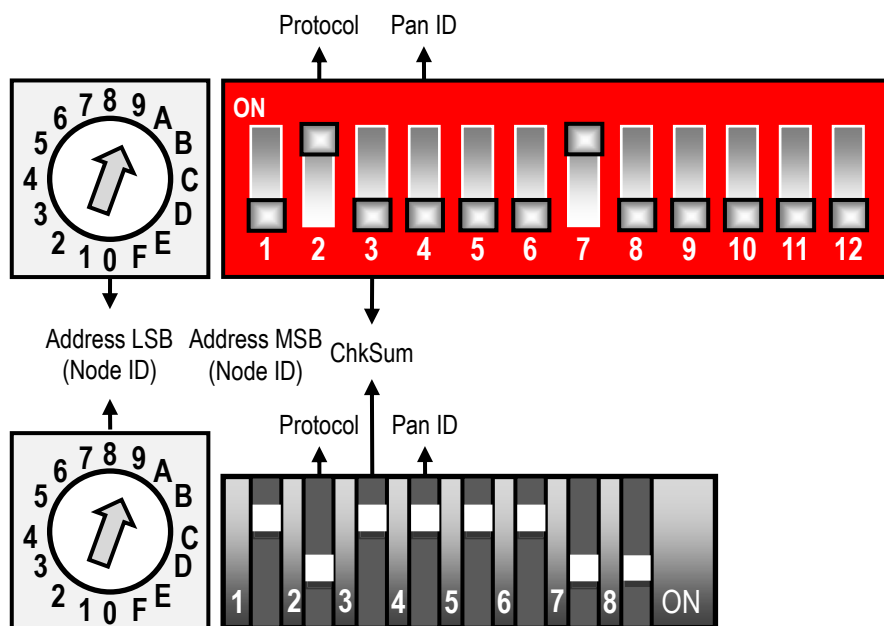

Figure 4.2 ZT-2055 (upper) and ZT-2060 (bottom) Set parameters diagram

4.1.2. Serial Port Communication Interface

◆ Parameter description

Table 4.3 below is the descriptions for the Serial port parameters and setting notes.

Table 4.3 Serial port related parameter descriptions

Project	Description	Note
Baud Rate	Communication Baud rate	Support eight kinds of communication baud rate - 115200 / 57600 / 38400 / 19200 / 9600 / 4800 / 2400 / 1200 bps
		Please set the same as the Modbus RTU device
Data Format	Communication Data format	Support five kinds of parity check codes - None / Odd / Even / Mark / Space Supports 7/8 data bit Support 0/1/2 stop bit
		Set the same with the connected Modbus RTU device
Inter-character Timeout	Timeout for ending command reception	Valid range is 1.5 to 10 character-time
		The default is the standard Modbus communication protocol 3.5 character time, the user can adjust according to the requirement

◆ Set Example

Table 4.4 shows a setting example to set the RS-485 of MDC-211-ZT as a Modbus Master, and the recommend parameter values for the Serial port.

Table 4.4 MDC-211-ZT and M-7000/PLC setting example

Project	MDC-211-ZT	M-7017	M-7060	PLC
Baud Rate	115200			
Data Format	N,8,1			
Inter-character Timeout	3.5	N/A	N/A	N/A

4.2. Modbus Protocol Parameter Descriptions

MDC-211-ZT is a Modbus data concentrator with Zigbee / RS-232 / RS-485 / Ethernet interfaces. The users need to set a communication interface to Modbus Master / Modbus Slave (The interface not used can be set to "Disabled"). The following sections describe the parameters for setting to Modbus Master and Modbus Slave.

4.2.1. Modbus Master Setting Parameters

◆ Parameter Description

Table 4.5 shows the descriptions for the Modbus Master setting parameters and the setting notes.

Table 4.5 Modbus Master related parameter descriptions

Item	Description	Note
Modbus Timeout	Polling Timeout	It is the maximum time for waiting the response from Modbus RTU device. If there is no response after the time expires, it is considered as timeout and execute the next command.
		Users can change the value as needed.
Modbus Retry	Number of polling Retries	When the number of command timeouts exceeds the number of retries, the MDC-211-ZT regards the Modbus RTU device as offline and performs the following two operations: a. Suspend this polling command for 10 seconds until the device is back online again b. The status of the Modbus command can be read via the Internal Register of MDC-211-ZT, where the Register value of 0xFFFF is represented the timeout. (For more information can see Chapter 5. FAQ-Q5)
		The default of Modbus Retry is 3 times, users can change the value as needed
Polling Interval	Polling Interval	The interval time for command polling to avoid communication signal collisions.
		Users can change the value as needed

◆ Example

Table 4.6 below is a setting example to set MDC-211-ZT to Modbus Master, and the recommend parameters.

Table 4.6 MDC-211-ZT and M-7000 or PLC communication setting example

Project	ZigBee	RS-485	RS-232
Modbus Timeout	200	150	150
Modbus Retry	3	3	3
Polling Interval	30	20	0

4.2.2. Modbus Slave Setting Parameters

◆ Parameter description

Table 4.7 below is the descriptions for Modbus Slave setting parameters and the setting notes.

Table 4.7 Modbus Master related parameter descriptions

Item	Description	Note
Modbus ID	Modbus	The station number for setting MDC-211-ZT to Modbus
	Station	Slave
	Number	Users can change the value as needed (1~255)

5. FAQ

Q1 - What are the maximum numbers of polling definition and Internal

Register in a MDC-211-ZT?

The maximum number of polling definition in a MDC-211-ZT is 240 commands, each definition can access up to 64 Internal Registers. Each of the four tables (DI/DO/AI/DO) can store up to 9600 Internal Registers for polled data.

Q2 - What is the maximum number of data can be accessed in one

command from a Modbus Master device?

By the Modbus TCP protocol, the maximum amount of Internal Registers that one Modbus command can access is 255 of function code 01 and 02, and 126 of function code 03 and 04.

Q3 - How are the Internal Registers corresponding to the polled data in a

MDC-211-ZT?

Please refer to the "2.6.2 Inquire Corresponding Modbus Register Address" for the detail information.

Q4 - How to write data to output channels on a Modbus RTU Slave device?

◆ Web Interface Operation

Refer "2.6.3 Testing I/O Channel Status of Modbus RTU Device" for the detail information.

◆ Modbus TCP/RTU Protocol

The users can write data with corresponding function code 05/06/15/16 to the mapping addresses of MDC-211-ZT Internal Register, and then can control the output channels of the Modbus RTU Slave devices.

ID	Number	Remote	MDC-211-ZT	Status
01	#001	[00000:00003]	[00000:00003]	GOOD
	#002	[10000:10005]	[10000:10005]	GOOD
02	#005	[00000:00003]	[00004:00007]	GOOD
	#006	[10000:10005]	[10006:10011]	GOOD
03	#007	[00000:00013]	[00008:00021]	GOOD

Figure 5.1 Modbus Internal Register table in Web interface

【Example】 In Figure 5.1 above, it is assumed that the Modbus slave ID of MDC-211-ZT is 0xAA. At the same time it is also acting the Modbus Master, the command of number #007 controls the DO channel of I/O device (e.g. ZT-2043, 14-ch DO).

Originally, the PC uses the function code 15 to control the Internal Register [00000:00013] of Modbus RTU device (Modbus ID: 03) directly. When the MDC-211-ZT is added as a modbus data concentrator, the PC needs to poll the MDC-211-ZT instead. Therefore, the command needs to be changed according to the corresponding Internal Register table above, to control the Internal Register [00008:00021] of MDC-211-ZT (Modbus ID: AA). The commands as shown below:

Original command	03 0F 00 00 00 0E 02 FF 3F + CRC16
New command	AA 0F 00 08 00 0E 02 FF 3F + CRC16

Q5 - How to read each MDC-211-ZT command status via the Modbus

communication?

MDC-211-ZT can view the real-time status of each Modbus command directly in a Web UI, and also store the status in the Internal Register starting with the address 39600 (0x2580), that meaning the Modbus Master can use function code 04 to read the command status. One command can read up to 126 Internal Register data.

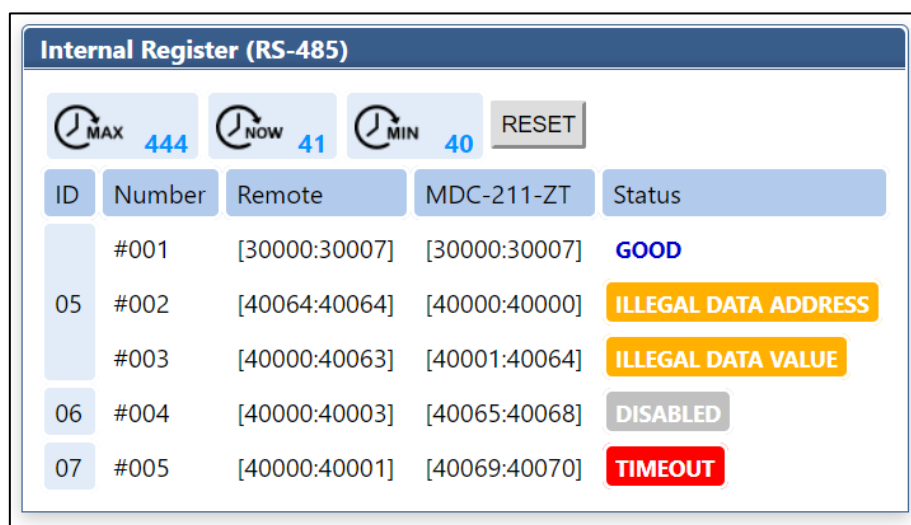

Figure 5.2 Modbus command real-time status example

For example of Figure 5.2 above, Modbus Master uses the function code 04 to read the connection status from 39600 as Table 5.1.

Table 5.1 The corresponding Internal Register address of the command status

Command No.	Addresses	State Code	Web Page Display
#001	39600	00 00	GOOD
#002	39601	83 02	ILLEGAL DATA ADDRESS
#003	39602	83 03	ILLEGAL DATA VALUE
#004	39603	FF 00	DISABLED
#005	39604	FF FF	TIMEOUT

The descriptions for the Read status:

- 0: Indicates that the connection is in normal status.
- 0xFFFF: Connection Timeout
- 0xFF00: Command not enabled (Disabled)
- 0x8XYY: Communication error. X-function code, YY– Error code, as Table 5.3 below

Table 5.3 Error code of the command status

Error Code	Name	Description
01	Illegal Function	This function code is not supported
02	Illegal Data Address	Illegal data address
03	Illegal Data Value	Illegal data value
04	Illegal Response Length	The requested data length exceeds the allowable length of the Modbus protocol.
0F	CRC Error	CRC error for the command response

Q6 - How to update the firmware?

Mdc-211-ZT can update the firmware via a software tool (Windows) by the following steps:

(1) Please go to the file center of the MDC-211-ZT product website to download the latest version of firmware and software (FW_Update_Tool) to your computer.

- **Product website:** <https://www.icpdas.com/en/product/MDC-211-ZT>

(2) Short the FW with GND of MDC-211-ZT and turn on the power. When the six LEDs of MDC-211-ZT turn blinking alternately, the MDC-211-ZT is successfully entered the firmware updating mode.

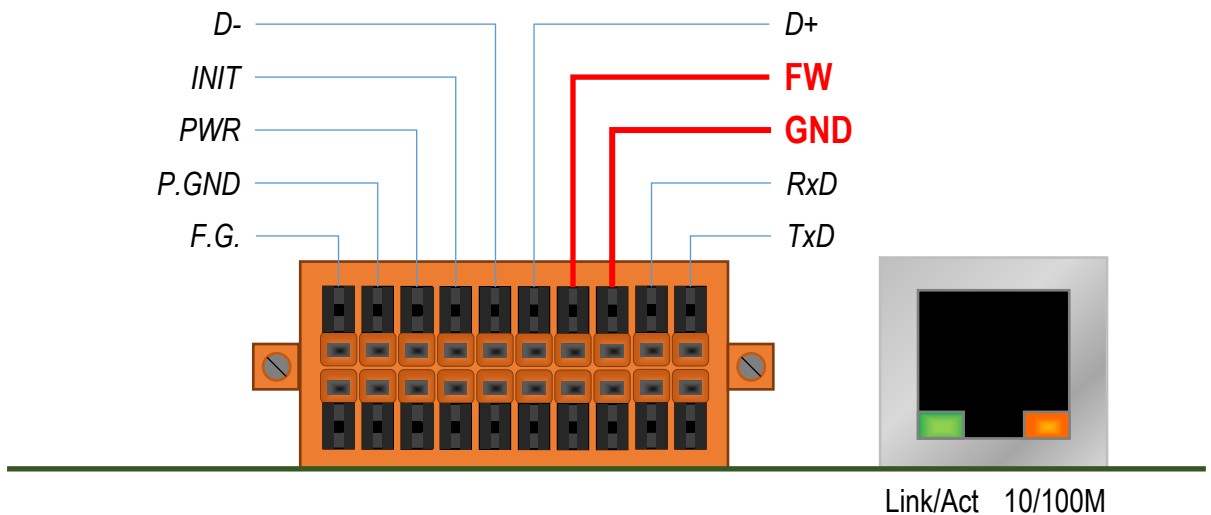

(3) Execute "FW_Update_Tool.exe" with the administrator privileges (👤) and follow the steps as Figure 5.3:

In "Download Interface", select a network port for connecting to MDC-211-ZT.

In "Firmware Path", select the latest firmware update file (MDC211ZT_xxxx.fw).

In "Firmware Update", click "Update" to start the firmware updating.

(4) When the update is completed, "Update OK" will be displayed in the "FW_Update_Tool" window to indicate that the firmware updating is successful. Next, remove the short connection between FW and GND, and reboot the power supply, then check the current firmware version on the Web interface.

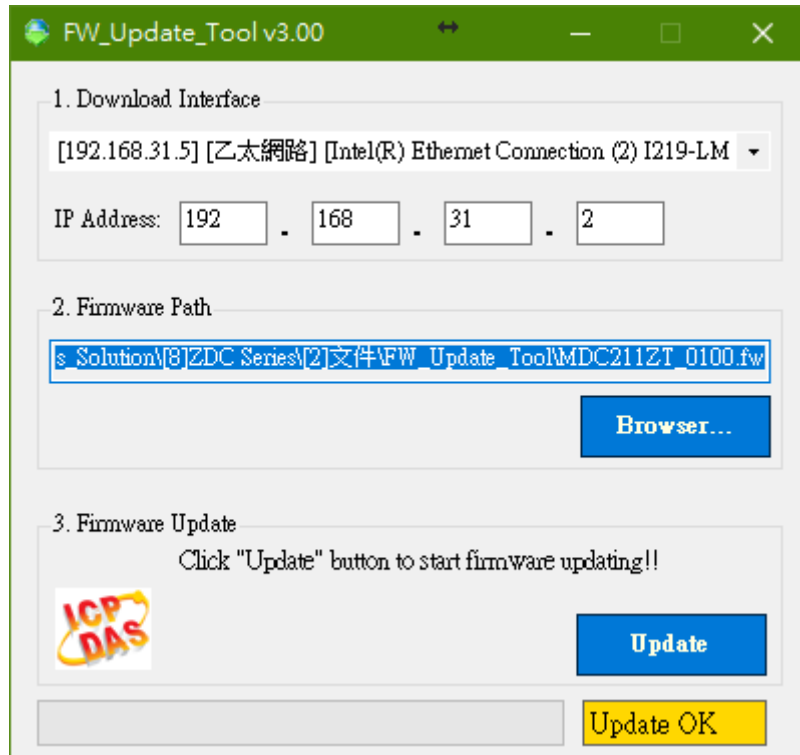

Figure 5.3 FW_Update_Tool firmware update steps

6. Appendix

6.1. LED Indicator State Descriptions

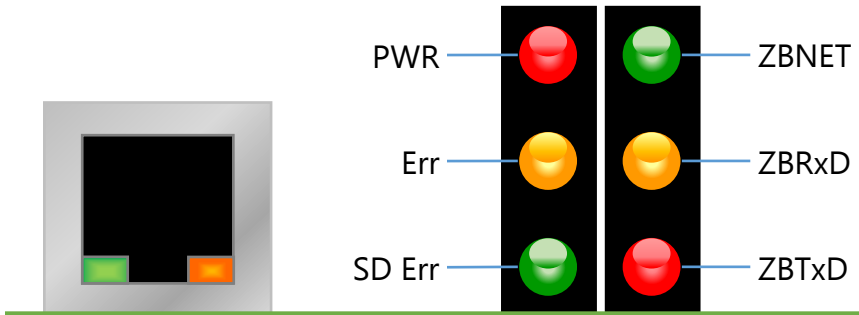

Figure 6.1 LED position diagram

Table 6.1 LED Description

LED Indicator	State	Description
ZBNET	[ZigBee Coordinator (Host)] ZigBee Network / Signal State Indicator	
	Steady Lit	ZigBee network has been established
	Blink to Steady Lit	Rejoin ZigBee network or it was occupied
	[ZigBee Router (Slave)] ZigBee Network / Signal State Indicator	
	Steady Lit	Signal strength good
	Blinking (500 ms.)	Signal strength general
	Blinking (1 sec.)	Signal strength weak
	Blinking (2 sec.)	Signal strength poor or no ZigBee network
ZBRxD	ZigBee Communication LED (Receive)	
	Blinking	Receiving ZigBee data
	Steady Unlit	Waiting to receive ZigBee data
ZBTxD	ZigBee Communication LED (Transmit)	
	Blinking	Transmitting ZigBee data
	Steady Unlit	Waiting to transmit ZigBee data

PWR	Steady Lit	Firmware loaded correctly
	Steady Unlit	Firmware loaded failed
	Blinking (1s)	Already short the FW pin to P.GND, but the Ethernet doesn't be connected
Err	Steady Unlit	No errors
	Blinking (500 ms)	There are Modbus command polling errors
SD	Function reserved	

【Other】 If the above six LEDs are blinking alternately, the module is into the firmware update mode (bootloader), which can update the firmware with the "FW_Update_Tool". For more information please refer to the FAQ - Q6.