

# UA-2800 User Manual

V1.0, 2024/11

## IIoT Communication Server



**UA-2841M**

Technique: Sun Chen; Translation & Edition: Eva Li;  
R&D Dept., ICP DAS CO., LTD.  
Latest edited by: Eva Li; V1.0, 11/2024

## Warranty

All products manufactured by ICP DAS are under warranty regarding defective materials for a period of one year, starting from the date of delivery to the original purchaser.

## Warning

ICP DAS CO., LTD. assumes no liability for damages consequent to the use of this product. ICP DAS CO., LTD. reserves the right to change this manual at any time without notice. The information furnished by ICP DAS CO., LTD. is believed to be accurate and reliable. However, no responsibility is assumed by ICP DAS CO., LTD. for its use, or for any infringements of patents or other rights of third parties resulting from its use.

## Copyright

© Copyright 2015 by ICP DAS CO., LTD. All rights reserved worldwide.

## Trademark

The names used for identification only maybe registered trademarks of their respective companies.

## License

The user can use, modify and backup this software on a single machine. The user may not reproduce, transfer or distribute this software, or any copy, in whole or in part.

## Technical Output:

Please contact local agent or email problem-report to [service@icpdas.com](mailto:service@icpdas.com) .

For more product information, please refer to <https://www.icpdas.com> .

# Table of Contents

<b>Table of Contents</b> .....	<b>3</b>
<b>Document Version Modify List:</b> .....	<b>7</b>
<b>1. Introduction: UA-2800 IIoT Communication Server</b> .....	<b>8</b>
1.1 Introduction .....	8
1.2 Features .....	9
Function Features .....	10
1.3 Specifications.....	13
Hardware Specifications: UA-2800 Series .....	13
Software Specifications: UA-2800 Series .....	15
1.4 Appearance / Pin Assignment .....	17
1.5 Dimensions .....	18
<b>2. Quick Start 1: Hardware/Network Connection</b> .....	<b>19</b>
2.1 Hardware Connection .....	19
2.1.1 Preparations for Devices.....	19
2.1.2 Hardware Wiring .....	19
2.2 Network Connection.....	20
2.2.1 Connection by Factory Default Settings (For New UA).....	21
2.2.2 Connection by Utility Searching .....	24
<b>3. Quick Start 2: Web UI / Setting Steps</b> .....	<b>27</b>
3.1 Web UI Environment Overview .....	28
3.2 Setting Steps for Project / List.....	29
3.3 Project Setting – A Quick Setup Example.....	32
Step 1. Controller COM Port Setting.....	33
Step 2. Module Setting .....	34
Step 3. OPC UA Connection .....	37
Step 4. OPC UA Certificate .....	38
Step 5. Enable Converting Module .....	39
Step 6. Save Project.....	40
Step 7. Run the Project .....	40
<b>4. Function Wizard: Project Quick Setup</b> .....	<b>41</b>
4.1 [Module Communication Conversion] Category .....	43
4.2 [Module Connecting to Azure] Category .....	45

4.3 [Data Log] Category.....	47
4.4 [PID] Category .....	49
4.5 [APP Message Notify] Category.....	51
4.6 [MQTT_Customized] Category.....	52
<b>5 Main Menu: Parameter Settings .....</b>	<b>53</b>
5.1 Main Menu: System Setting .....	53
5.1.1 Controller Service Setting .....	54
5.1.2 Time Setting.....	55
5.1.3 Network Setting.....	57
5.1.4 Account Setting.....	61
5.1.5 Boot .....	62
5.1.6 COM Port Interface Setting.....	63
5.1.7 Web Secure .....	64
5.2 Main Menu: Module Setting.....	65
5.2.1 Modbus RTU (Master).....	66
** Scaling.....	71
** Bitwise .....	72
5.2.2 Modbus TCP (Master).....	73
** Scaling.....	78
** Bitwise .....	79
5.2.3 Modbus ASCII (Master).....	80
5.2.4 MQTT Module .....	85
5.2.5 EtherNet/IP ICP DAS Module.....	89
5.2.6 XV Module .....	93
5.2.7 Internal Module .....	96
5.3 Main Menu: IoT Platform Setting.....	100
5.3.1 MQTT Local Broker.....	101
5.3.2 MQTT Remote Broker.....	102
5.3.3 MQTT Group Connection.....	106
5.3.4 MQTT Connection - Microsoft Azure Platform .....	110
5.3.5 OPC UA Connection - Local Server .....	113
5.4 Main Menu: Convert Setting.....	116
5.4.1 OPC UA and Modbus RTU/ASCII Conversion.....	118
5.4.2 OPC UA and Modbus TCP Conversion .....	121

5.4.3 OPC UA and MQTT Conversion .....	124
5.4.4 OPC UA and EtherNet/IP Conversion .....	127
5.4.5 OPC UA and XV Module Conversion .....	130
5.4.6 OPC UA and Internal Conversion.....	132
5.4.7 MQTT and Modbus RTU/ASCII Conversion .....	135
5.4.8 MQTT and Modbus TCP Conversion .....	139
5.4.9 MQTT and EtherNet/IP Conversion.....	143
5.4.10 MQTT JSON and Modbus RTU/ASCII Conversion.....	147
5.4.11 MQTT JSON and Modbus TCP Conversion .....	150
5.4.12 MQTT Custom and IoT Cloud Conversion.....	153
5.4.13 SNMP and Modbus RTU Conversion .....	156
5.4.14 SNMP and Modbus TCP Conversion .....	159
5.5 Main Menu: Advanced Setting.....	162
5.5.1 PID Operation .....	163
5.5.2 IFTTT Condition Trigger .....	168
5.5.3 RESTful .....	175
5.5.4 SNMP Agent .....	178
5.5.5 Data Logger: Local Data Logger .....	180
CVS local data log file: fields and example .....	182
5.5.6 Data Logger: MS SQL.....	183
Offline Data Recovery Mechanism .....	186
MS SQL Remote Database Example Descriptions: .....	187
5.5.7 Data Logger: MySQL / MariaDB .....	189
MySQL/MariaDB Remote Database Example Descriptions: .....	192
5.5.8 Block List: Block Rule.....	196
5.5.9 Block List: Block Status.....	198
5.6 Main Menu: Logger Setting .....	199
5.6.1 Local Data Logger: RTU / TCP Module (Master) .....	200
5.6.2 MS SQL: RTU / TCP / MQTT Module (Master).....	203
5.6.3 MySQL / MariaDB: RTU / TCP / MQTT Module (Master).....	206
5.7 Main Menu: I/O Status .....	209
5.8 Main Menu: File Setting .....	210
5.8.1 Project File.....	211
5.8.2 OPC UA Certificate .....	212
5.8.3 MQTT Certificate.....	214

5.8.4 Log File Download .....	216
5.8.5 SNMP MIB File .....	217
5.8.6 Firmware Update .....	218
<b>6. Factory Setting Recovering and Firmware Updating.....</b>	<b>219</b>
6.1 Recovering to Factory Setting (Rotary Switch: 8).....	219
6.2 Updating Firmware A – via Web UI of UA.....	220
6.3 Updating Firmware B - via USB (Rotary Switch: 9) .....	221
<b>7 Security Certificate: Download / Upload.....</b>	<b>222</b>
OPC UA Server Certificate management.....	222
MQTT Client Certificate management.....	222
7.1 Download the Certificate from UA Controller .....	224
7.2 Upload the Certificate to UA Controller.....	225
7.2.1 OPC UA Certificate .....	225
7.2.2 MQTT Certificate.....	226
<b>Appendix A. MQTT JSON Format of the UA Series.....</b>	<b>227</b>
<b>Appendix B. Protocol Technical Reference .....</b>	<b>228</b>
<b>Appendix C. LED Indicators.....</b>	<b>229</b>
<b>Appendix D. Mounting the XV-board for UA Series .....</b>	<b>230</b>

## Document Version Modify List:

Version	Description
V1.0	Date: 2024/11 1. Appendix C: change RUN LED to “ON” and waiting for “30 seconds”.
	Date: 2024/01. 1. Update software security function * OPC UA Server: add 3 items * MQTT Broker: support TLS version 1.3 * MQTT Client: support TLS version 1.3
	Date: 2023/07 First Version. UA-2800 has the following new functions comparing with the UA-2200/2500 series: 1. Serial port name: UA-2800 uses “ <b>COM#</b> ” (UA-2200/5200 uses “ttyO#”). 2. Storage: UA-2800 adds <b>SSD</b> , in addition to the Micro SD. 3. New function: <b>SNMP</b> communication protocol Add new Wizard <b>SNMP</b> example (CH4.1) Add new function <b>SNMP [Convert Setting]</b> (CH5.4.13~5.4.14) Add new function <b>SNMP Agent [Advanced Setting]</b> (CH5.5.4) Add new function <b>SNMP MIB File [File Setting]</b> (CH5.8.5) 4. New function: <b>RESTful [Advanced Setting]</b> Web communication service for easy access to device data. (CH5.5.3)

# 1. Introduction: UA-2800 IIoT Communication Server

This chapter introduces UA-2800 series and its functions, software/hardware specifications.

## 1.1 Introduction

**UA-2800 Series** is a series of **IIoT (Industrial IoT) Communication Server** for integrating the system and devices of IT and OT. UA features the IIoT Gateway function that allows users to access the remote I/O modules and controllers via Modbus TCP/RTU/ASCII, MQTT, and EtherNet/IP communication protocols. IIoT gateway function can also convert these I/O data to OPC UA or MQTT protocols for the needs of connecting with the MES, ERP, SCADA and Cloud services. Besides, UA features the Data Logger function that allows users to write the I/O data directly into the remote database, and save to the local file as the historical records. UA supports Cloud platform that can connect to Amazon AWS, Microsoft Azure or other Cloud platforms to send over the I/O data; and support Cloud logic service platform “IFTTT” which can connect many web APPs that allows users to receive first-hand notification messages through the most commonly used mobile APPs when an event triggered. UA Series enhances the networking and interoperability between IT and OT. Through UA series, users can easily deploy for Industrial IoT.

- **UA Series:**

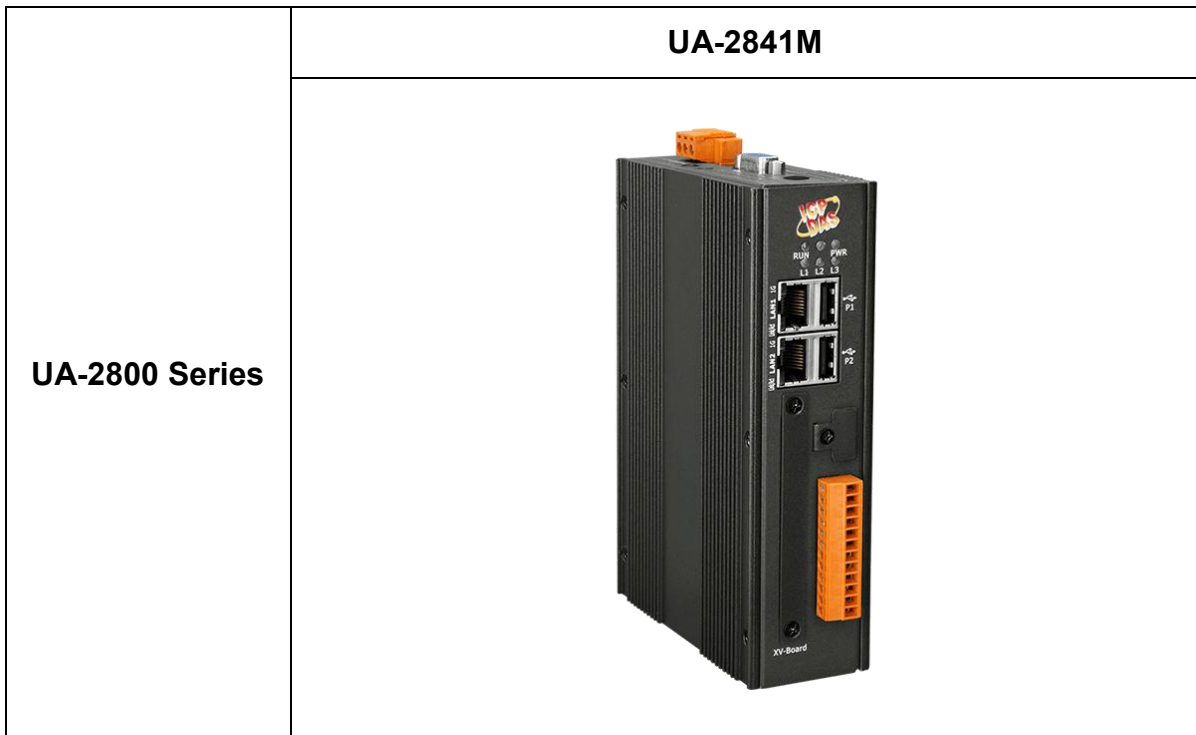

## 1.2 Features

### UA-2800 Series Features

- Simultaneous Writing for Remote Database and Local Data Logger
- Offline Data Recovery Mechanism for Remote Database
- Support to Enable OPC UA, MQTT, SNMP and RESTful at the Same Time
- MQTT Broker (Including WebSocket)
- Support a Complete Information Protection Mechanism
  - HTTPS, SNMP v3, Communication Encryption, Block List
- IoT Cloud Platform Connection
  - Microsoft Azure, Amazon Web Services, IBM Bluemix, Alibaba Cloud
- IFTTT Logic Control Triggers the APP Notification Function
- PID Logic Operation Function

● **Function Features**

■ **Built-in OPC UA Server Service**

Compliable with IEC 62541 Standard. Provides functions of Active Transmission, Transmission Security Encryption (SSL/TLS), User Authentication (X.509 Certificates / Account password), Communication Error Detection and Recovery, etc. to connect SCADA or OPC UA Clients. Allowed up to 8000 OPC UA tags and up to 20 sessions for the OPC UA Client connection.

■ **Built-in MQTT Broker Service**

MQTT Broker (non-SSL & SSL/WebSocket) inside and compliable with MQTT V.3.1.1 protocol. Provides functions of IoT Active M2M Transmission, QoS (Quality of Service), Retain Mechanism, Identity Verification, Encryption, Last Will, MQTT Client Drivers, etc. The MQTT Broker supports 200 MQTT Client or device connections, not to over 400.

■ **Provide SNMP Agent function (For UA-2800)**

UA-2841M series products allow IT practitioners to manage various workplaces through ICP DAS NMC-9181 or third-party SNMP software.

■ **Provide RESTful API service interface (For UA-2800)**

Provide the device data in JSON format, letting the user access it from the outside through the HTTP protocol. And UA support to execute OPC UA, MQTT and RESTful API communication at the same time.

■ **Support to Enable OPC UA, MQTT, SNMP and RESTful at the Same Time**

■ **Support Ethernet and Serial Communication Modules**

- ▶ Ethernet : UA supports Modbus TCP, MQTT , and ICP DAS EtherNet/IP modules
- ▶ Serial : UA supports Modbus RTU/ASCII modules (Max. 3 Serial ports)
- ▶ UA Web UI : users can quickly set up the modules and display the real-time I/O status.
- ▶ Max. modules supported by each connection:

Communication UA Series	Ethernet			Serial
	MQTT	Modbus TCP	EtherNet/IP	Modbus RTU/ASCII
UA-2800	500	250	125	32 x 3(ports)
UA-2200/5200	200	100	50	32 x 3(ports)
UA-7200	200	100	50	32 x 1(port)

## ■ **Sensor Data Upload with Information Security**

In the era of cloud IoT, data transfer between sensors and cloud or graphical control platforms is a prerequisite for the operation of the IoT system, And enabling "sensor data upload" to be protected by security mechanisms is the priority of IoT systems. The HTTPS of the UA series protects web data from leakage while the "MQTT with SSL/TLS" and OPC UA Server features that the sensor's real-time data upload is transmitted through encryption to prevent theft and use by anyone. In addition, the UA-2841M supports SNMP (V3) agent (Enhanced security for SNMP protocol) information security protocol. Through the Firewall protection and Protocol data encryption mechanism provided by UA, it can meet the user's needs when building the IoT system.

## ■ **Save I/O Data Directly into Remote Database & Local Side LOG File**

UA series can collect devices I/O status and then directly save into remote side SQL Database. UA series can also save I/O data into a CSV log file on the local side. Furthermore, users can set the time interval of which CSV file to generate and divide on the local side.

## ■ **Offline Data Recovery Mechanism**

For general data collection, the sensor data will be sent to the control center and imported into the Database at cloud. But when the network experience a disconnection, the data transmitted during the offline period will be lost. UA Series supports the Offline Data Recovery mechanism. When experiences network disconnection, all data will be stored in the SD cards in UA Series. And when the network return to normal status, the data stored in SD card will be re-sent to UA, and imported into Database to ensure the integrity of historical data.

## ■ **Support Cloud Platforms Connection**

UA can actively connect to Amazon AWS, Microsoft Azure or other IoT Cloud platforms to send over the I/O data.

## ■ **Support Logic Control IFTTT to Send Event Messages to LINE... APPs**

UA can combine the IFTTT cloud platform functions and send messages over 460 Web APPs (such as Line, Twitter, etc.) when the special events occur. The device I/O change can be set to trigger the event of the IFTTT cloud service, and the IFTTT logic control (If This, Then That) will immediately let the pre-set Web Service (Such as LINE) send a message to one user or group to handle the event immediately.

- **Provide Function Wizard Web UI for easily step-by-step setup**

The Web UI of UA provides a wizard-like “Step Box” in the Function Wizard area to guide user step-by-step to complete the project or function. It provides many items for setting the Communication Conversion, Azure Connecting, Function Configuration, PID Operation, Condition Trigger the APP Message Notification, and will be more. It will help users to set projects easily and quickly.

- **Provide Internal Module that can create virtual variables as an intermediary for reading, writing, or data exchange**

Provides UA server settings for the Internal variables of the Internal virtual module, allowing two OPC UA Clients that cannot directly exchange data to communicate with each other and convert data messages through the Internal variables of the Internal module.

\* Create internal variables: 8 Internal virtual modules can be set, each module has 100 Internal variables (points).

\* Communication protocol conversion: Provides Internal to OPC UA Server communication conversion.

# 1.3 Specifications

## ● Hardware Specifications: UA-2800 Series

<b>Model</b>	<b>UA-2841M</b>
<b>Main Unit</b>	
CPU	ARM Quad-Core CPU, 1.6 GHz
System Memory	DDR4 SDRAM 2 GB
Storage	<ul style="list-style-type: none"> <li>· Flash 8 GB</li> <li>· microSD socket with one 4 GB microSD card (support up to 32 GB microSDHC card or 2 TB microSDXC card) mini PCIe Socket, Solid-state drive (SSD) can be expanded by accessories</li> </ul>
Non-Volatile Memory	FRAM 64 KB MRAM 128 KB
Real Time Clock	Provide second, minute, hour, date, day of week, month, year
<b>Display</b>	
Signal	VGA (Analog RGB), reserved
<b>LED Indicators</b>	
Status	<ul style="list-style-type: none"> <li>1 x PWR;</li> <li>1 x RUN;</li> <li>3 x User Defined LEDs</li> </ul>
<b>I/O Expansion</b>	
I/O Type	Support 1 optional XV-board to expand RS-485 or I/O ports (*1)
<b>COM Ports</b>	
Console Port	RS-232 (RxD, TxD and GND); Non-isolated
COM2	RS-232 (RxD, TxD and GND); Non-isolated
COM3	RS-485 ( Data+, Data- ); 2500 VDC isolated
COM4	RS-485 ( Data+, Data- ); 2500 VDC isolated
<b>HMI</b>	
Rotary Switch	1 x 10 Position (0 ~ 9)
<b>Ethernet</b>	
Ports	2 x RJ-45, 10/100/1000 Based-TX ( Auto-negotiating, Auto MDI/MDI-X, LED indicators )

<b>Model</b>	<b>UA-2841M</b>
<b>USB</b>	
Connector	2 x 2.0 host
<b>Power</b>	
Input Range	+12 ~ +48 VDC
Consumption	10 W
<b>Mechanical</b>	
Casing	Metal
Dimensions (mm)	42 x 164 x 129 (W x L x H)
Installation	DIN-Rail
<b>Environmental</b>	
Operating Temperature	-25 ~ +75°C
Storage Temperature	-40 ~ +80°C
Humidity	10 ~ 90% RH, non-condensing

## Specification Memo:

- \*1. Refers to the **UA website Supported List** for the available **XV-board** and supported **UA models**.

● Software Specifications: UA-2800 Series

Model	UA-2841M
<b>OS</b>	
Linux	Linux Kernel 5.10.72
<b>Protocol (Note 1, Note 2).</b>	
OPC UA Server	<ul style="list-style-type: none"> <li>● OPC Unified Architecture: 1.02</li> <li>● Core Server Facet</li> <li>● Data Access Server Facet</li> <li>● Method Server Facet</li> <li>● UA-TCP UA-SC UA Binary</li> <li>● User Authentication: Username/Password, X.509 Certificate</li> <li>● Security Policy:               <ul style="list-style-type: none"> <li>&gt; None</li> <li>&gt; Basic128Rsa15 (Sign / Sign &amp; Encrypt)</li> <li>&gt; Basic256 (Sign / Sign &amp; Encrypt)</li> <li>&gt; Basic256Sha256 (Sign / Sign &amp; Encrypt)</li> <li>&gt; Aes128_Sha256_RsaOaep (Sign / Sign &amp; Encrypt)</li> <li>&gt; Aes256_Sha256_RsaPss (Sign / Sign &amp; Encrypt)</li> </ul> </li> <li>● Recommend Max. 50 Client Sessions, and Max. 8000 Tags. (Without using encrypted communication)</li> </ul>
MQTT Broker	Support the MQTT v3.1.1 protocol, provide MQTT message transmission and distribution management, and support TLS(1.3)/SSL and Web Socket communications. Recommend to keep the connection number of Clients within 500. Max. 2100 Client Devices. (Note 1)
MQTT Client	Connect the MQTT Broker to read/control the devices supporting the MQTT protocol. Or connect the MQTT Broker to externally read/control the devices supporting other protocols that link with the UA series (MQTT Ver. 3.1.1; TLS Ver. 1.3). Max. 500 Connections. (Note 1)
Modbus TCP Master	To read or control the devices that support standard Modbus TCP Slave protocol. Recommend to keep the maximum number of devices within 250 connections.
Modbus RTU/ASCII Master	A max. of 3 ports: COM2, COM3, COM4 to connect other Modbus RTU Slave devices (e.g. M-7000). Recommend no more than 32 devices per port (32*3 port) for better communication quality.
EtherNet/IP Scanner	Support connect EIP-2000 series modules of ICP DAS. Recommend Max. 125 devices per UA.

Model	UA-2841M
XV-board	Support XV-board series modules of ICP DAS.
SNMP	Provide SNMP Agent service, for users to external access the devices connected with the UA through the SNMP communication. Max. 10 read commands and 10 write commands at the same time.
RESTful	Provide RESTful API service, for users to external access the devices connected with the UA through the HTTP communication. Max. 20 read commands and 1 write command at the same time.
Firewall	
Dynamic Block list	Set conditions to monitor the connection status of the service port. When the external IP connections exceed the condition setting value, the dynamic block list will automatically block the subsequent connection of the IP to avoid a large number of abnormal connections from blocking network services and protect system stability
Data Logger (Note 2)	
Local Data Logger	Record I/O data, and save to the local MicroSD card or SSD in CSV format.
Remote Database	Record I/O data, and send to the remote database of MS SQL / MySQL / MariaDB. Recommend Max. 2 Databases per Time, and Max. 1000 Tags.
Function (Note 2)	
Internal Module	Can create virtual variables as an intermediary for reading, writing, or data exchange.
PID Function	Combine the remote I/O devices for the PID logic control system.
IoT Service Integration (Note 2)	
Microsoft Azure	MQTT Service can connect to MS Azure IoT Hub for Cloud platform service.
Amazon Web Services	MQTT Service can connect to AWS IoT Core for Cloud platform service.
IBM Bluemix	MQTT Service can connect to IBM Bluemix for Cloud platform service.
IFTTT	Support Logic event sending to IFTTT Web platform. IFTTT Logic Trigger APP (Line, Twitter, Gmail ...)

**Note 1:** The specifications in the table are the maximum number of connections or usage when using a single Protocol.

**Note 2:** When using multiple Protocol functions, the user needs to control the device number to **under 80%** of the CPU usage. Please refer to the CPU Usage of the UA Web UI.

# 1.4 Appearance / Pin Assignment

## UA-2841M

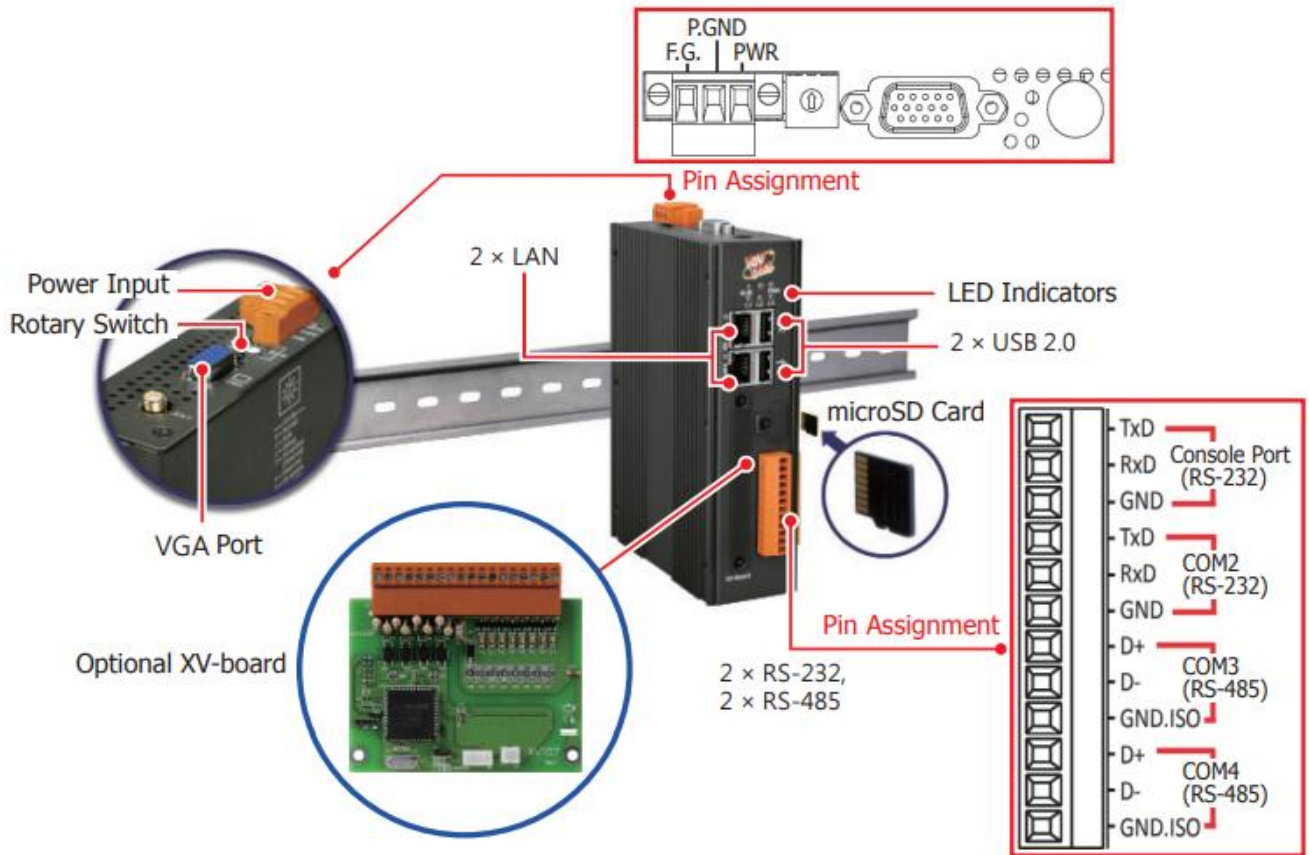

# 1.5 Dimensions

## UA-2841M

Unit: mm

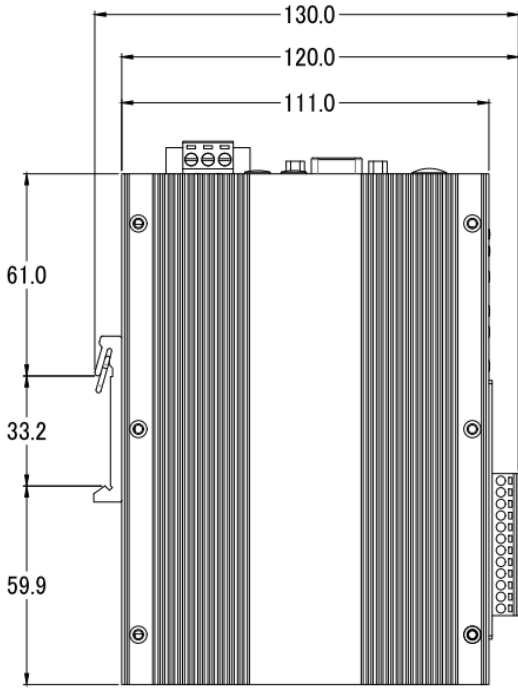

Left Side View

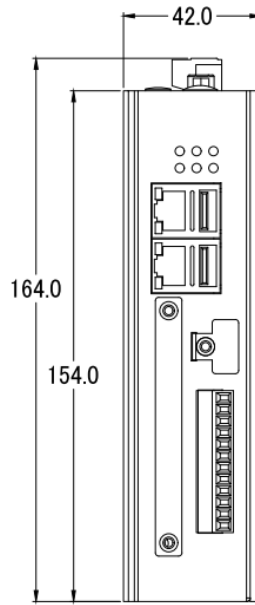

Front View

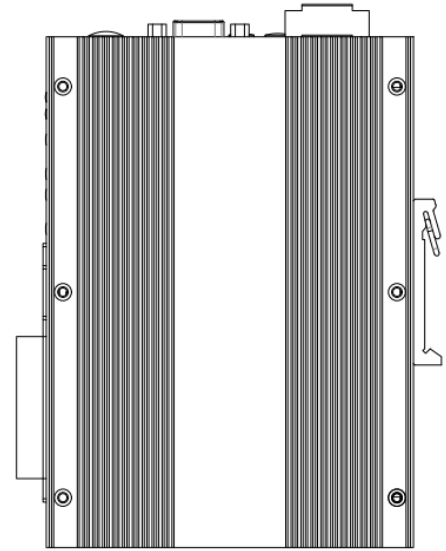

Right Side View

## 2. Quick Start 1: Hardware/Network Connection

This chapter describes the devices hardware connection, network connection and quick setting for the UA Controller, and how to connect to the UA controller web-based UI via a browser. Next chapter will set up web functions, and complete an example project.

### 2.1 Hardware Connection

This section describes the hardware wiring and connection for the UA Controller.

#### 2.1.1 Preparations for Devices

In addition to the UA series controllers (Ex: UA-2841M), please prepare the following:

1. **PC/NB**: Can connect to the network and set the network
2. **Ethernet Hub or Switch**: Ex: NS-205A, (or PoE Switch NSM-208PSE)
3. **Power Supply**: +12 ~ +48 VDC (Ex: MDR-60-24)

#### 2.1.2 Hardware Wiring

Connect the UA-2800 with the **LAN1** RJ-45 Ethernet port to an Ethernet hub/switch and PC. You can also link directly the UA to PC with an Ethernet cable.

After power is connected, please [ **wait 1 minute** ] for UA start-up procedure. When the "RUN/PWR" light ("RUN" "PWR" lights for UA-2800) starts flashing, it represents the boot is complete.

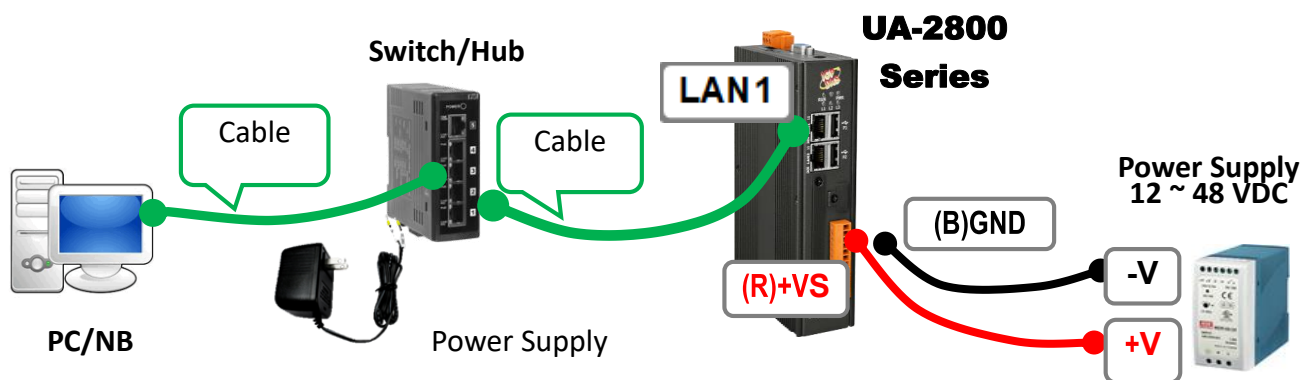

## 2.2 Network Connection

This section introduces how to connect to the UA Web User Interface (UA Web UI).

**Setting new UA or the new user please uses the method A in the Chapter 2.2.1** (The same method as the “UA Series Quick Start” manual).

**Other** users please see the following introductions to choose **method B(Sec.2.2.2)** or **C**.

The methods to login the UA series Web UI:

**A. Using Factory Default Setting:** Suitable for setting a new UA controller and the PC network IP is not in the same domain with UA. This method changes the PC network IP to be the same domain with the UA factory default network IP to login the Web UI. (Refer [Section 2.2.1](#))

**B. Using Software Utility:** Suitable for quick setting when many UA servers are in the network but the IP are unknown. UA Series provides a free software utility for auto searching UA controllers in the network and can quick jump to the login web page of UA. (Refer [Section 2.2.2](#))

**C. Using IP Address:** Suitable for the UA has a fixed IP and in the same domain with the PC. If the UA has a fixed IP and in the same domain with the PC, users can directly enter the IP in the address bar of a web browser and log in to the Web UI of the UA.

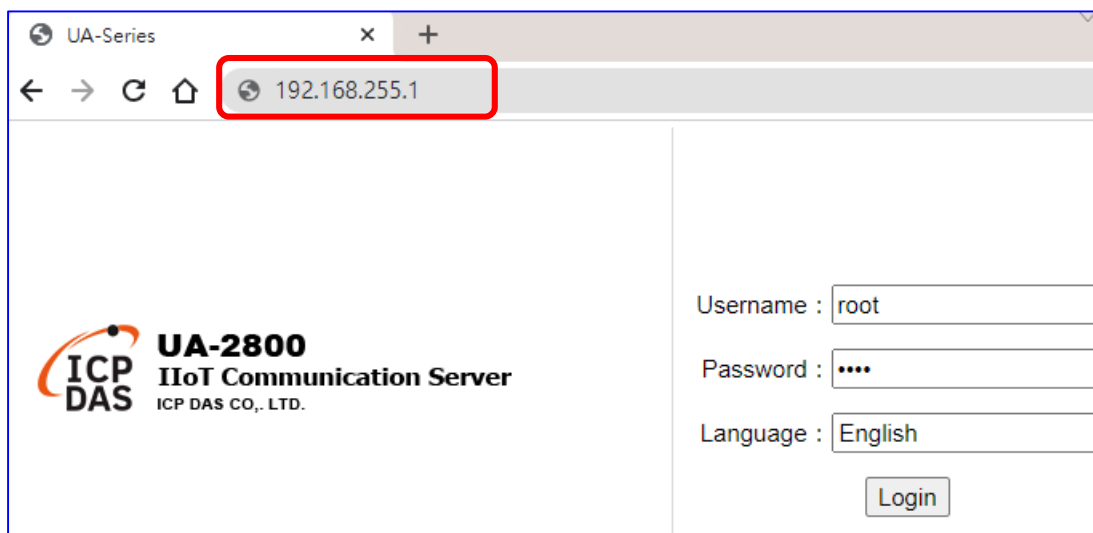

## 2.2.1 Connection by Factory Default Settings (For New UA)

The factory default settings of the UA series are as the following table:

Factory Default Settings of <b>UA Series</b>			
Network	IP	LAN1: 192.168.255.1 LAN2: 10.0.0.1	Assign UA a new IP setting according to your case. <b>UA-2800</b> series uses <b>LAN1</b> to connect PC.
	Mask	255.255.0.0	
	Gateway	LAN1: 192.168.1.1 LAN2: 10.168.1.1	
Web UI Account	Username	root	<b>After login, change the default username/password to use other functions.</b>
	Password	root	

### [Steps]

1. Change **PC's Network and Internet IP setting** to be **in the same network** with UA. **Note. Write down the PC's original IP settings before modifying. And change PC settings back after setting UA.**

EX:

Example: <b>PC's IP Setting Example</b>	
IP address	192.168.255.10
Subnet mask	255.255.0.0
Default gateway	192.168.1.1

Obtain an IP address automatically  
 Use the following IP address:

IP address:   
 Subnet mask:   
 Default gateway:

2. Make sure the UA and PC is connecting through Ethernet. And then open a PC side browser (Ex: Chrome, IE...). Type **UA's IP** <http://192.168.255.1> in the URL address. Use default Web UI username/password **root/root** to login the system.

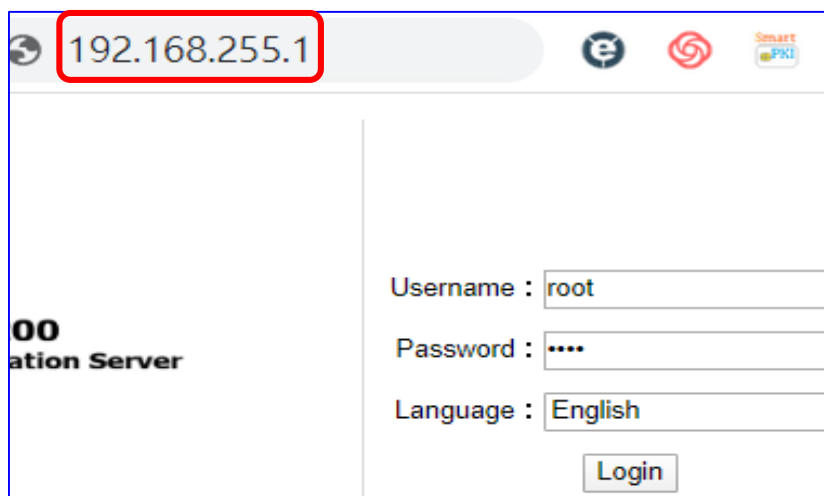

- Click **【System Setting】** → **【Account Setting】** to change the **default Username / Password** to use other functions (Functions will be gray before changed).

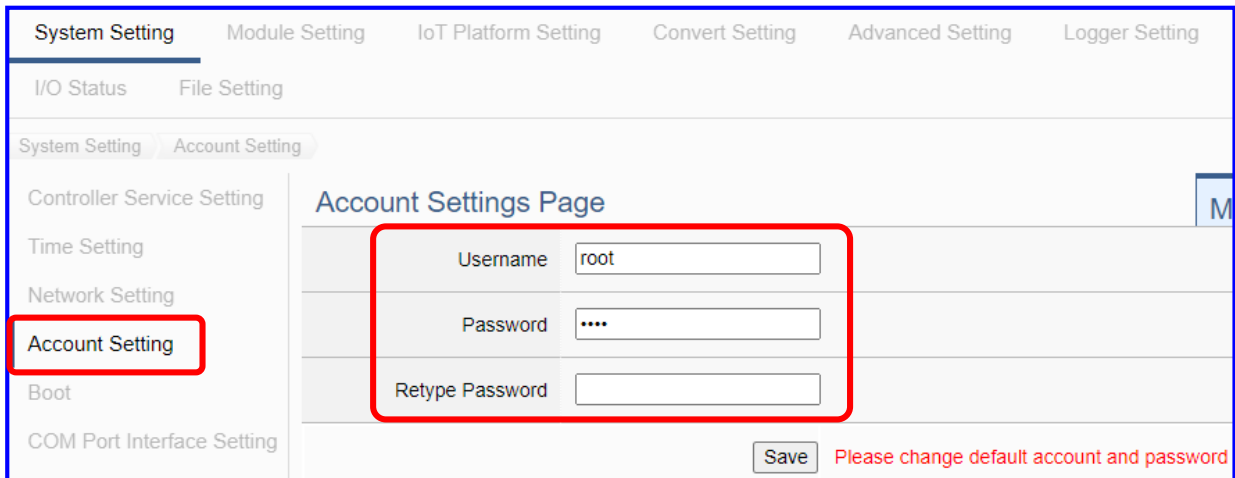

- Click **【System Setting】** → **【Time Setting】** , check if the **UA time** is correct. If not, **modify** or set **Time Synchronization**.

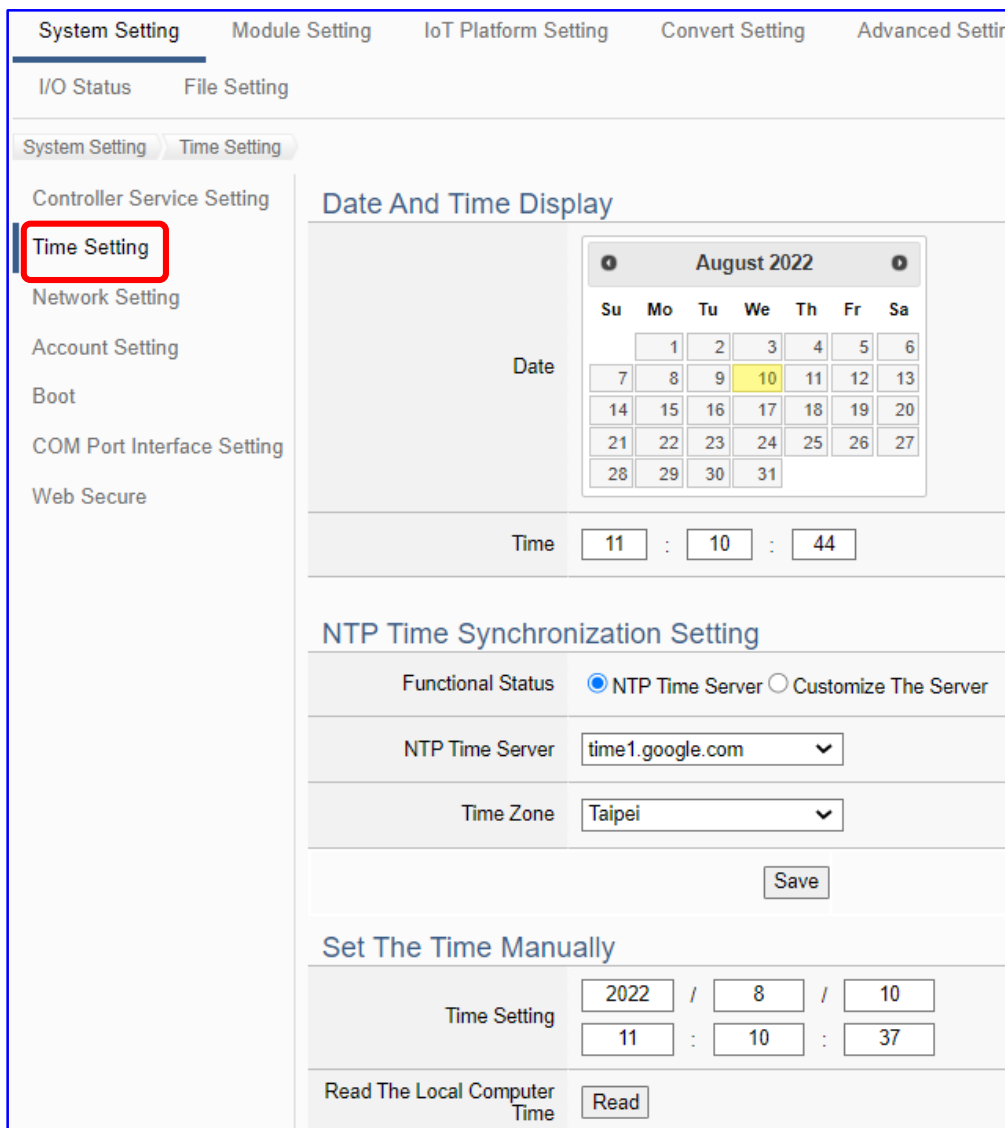

- Click **【System Setting】** → **【Network Setting】** > **【Network Setting(LAN1)】** to change the IP setting by user network.

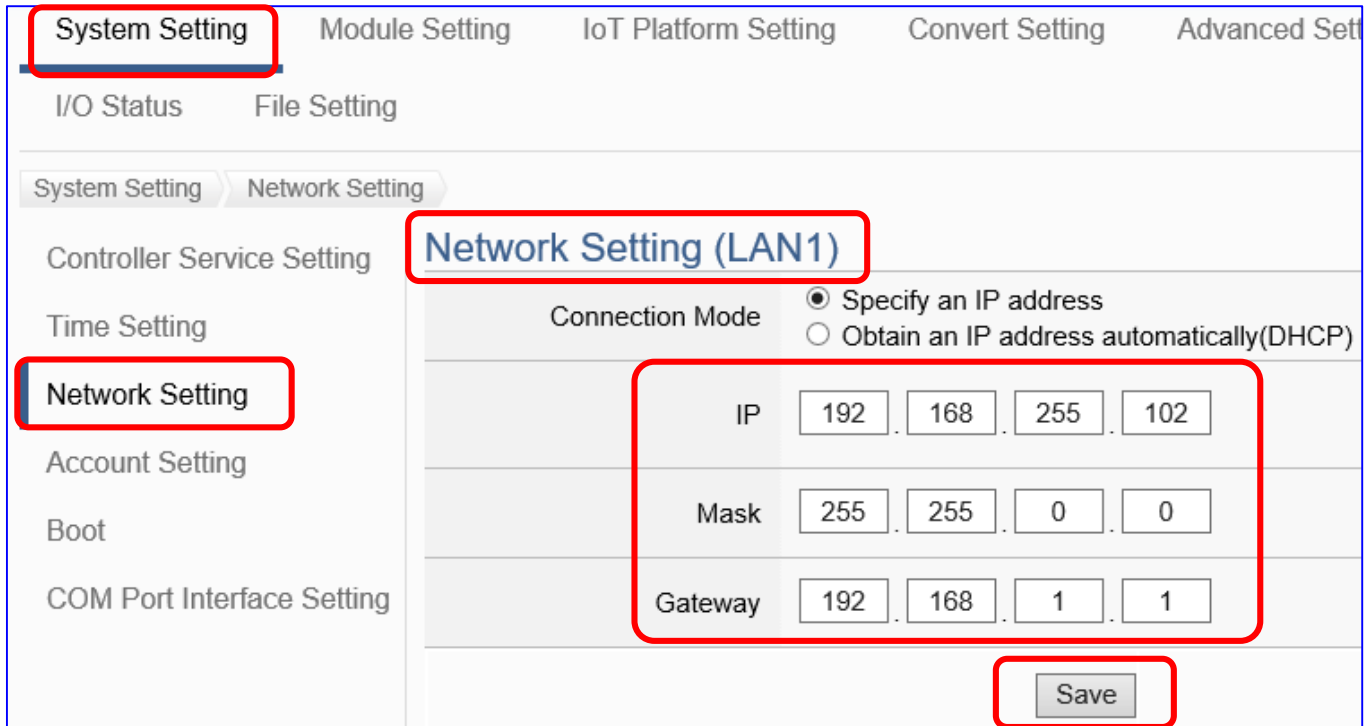

- Save the IP setting, restore the PC original IP settings, and type the **new IP** in the browser to login the Web UI of UA series. Then configure user's UA project.

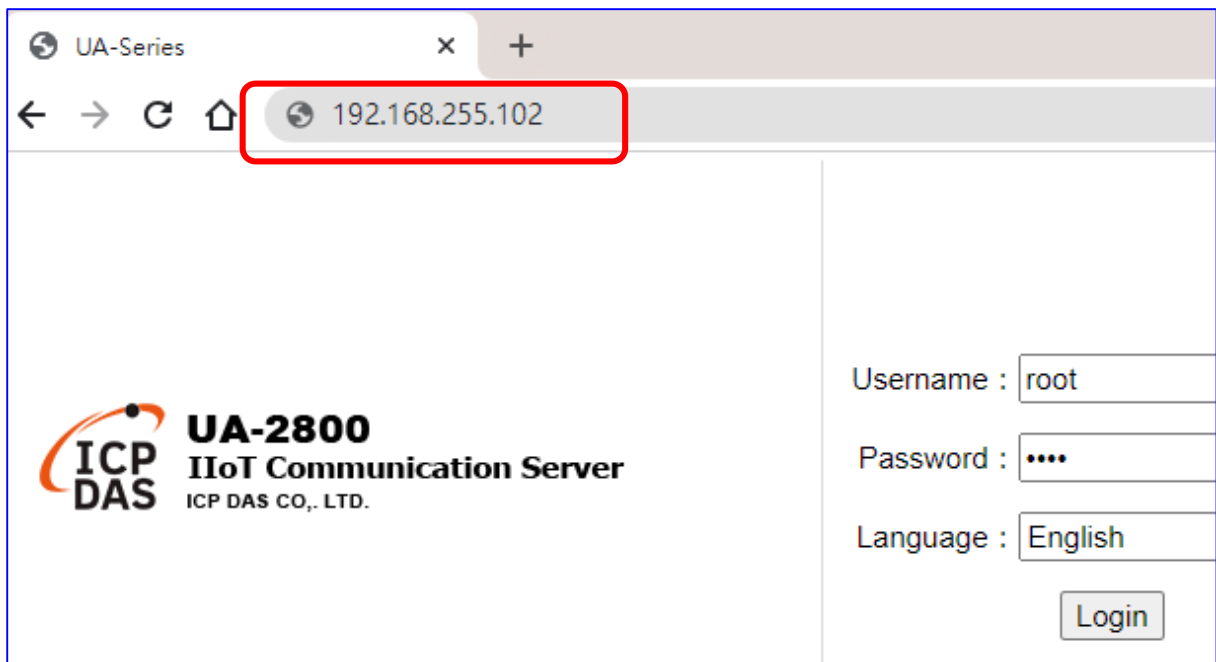

## 2.2.2 Connection by Utility Searching

Setting new UA or the new user please uses the method in the [Chapter 2.2.1](#). (A)

If the UA has a fixed IP and in the same domain as the PC, users can directly enter the IP in the address bar of a web browser and log in to the Web UI of the UA. (C)

This section introduces the 2nd method(B) that users use the UA Utility to search the Network IP. This method is suitable for connecting multiple UA series controllers to the Internet, but the IP addresses of UA are unknown or need to modify the UA quickly.

The Utility is a free tool software to quickly search each UA/BRK/UA-IO series on the network and connect to its Web UI for setting UA/BRK/UA-IO series products and project.

In the PC, download and install the Utility (EZ-UAQ Utility) suitable for your PC, and then run it to connect the device. Please download the utility program from the website:

<https://www.icpdas.com/en/download/show.php?num=8560&model=UA>

FILE NAME	VERSION	FILE DATE	SIZE	NOTE	
EZ-UAQ Utility-Framework3.5	v1.1.1	2023-03-29	1.68 MB		
EZ-UAQ Utility-Framework4.7	v1.1.1	2023-03-29	1.68 MB		

### 1. Install and execute the Utility

Download and unzip the Utility, double-click the executable file (EZ-UAQ Utility.msi) to install and execute the Utility software.

(If there is an old version of Utility on the PC, please uninstall it first.)

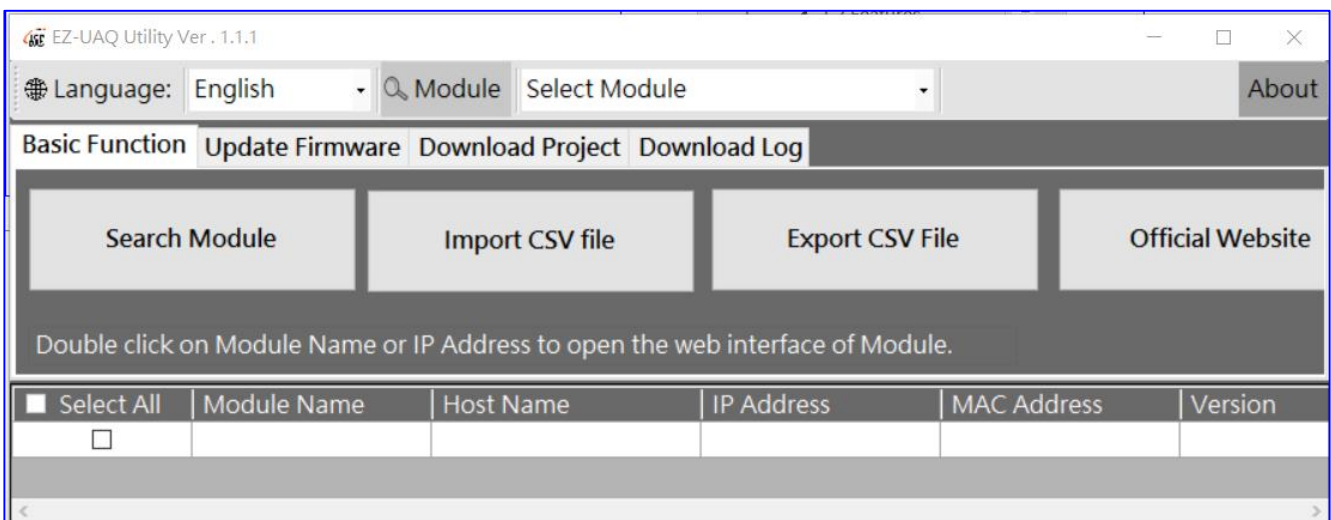

## 2. Search the UA/BRK/UA-IO series modules

Click the “Search Module” button, the utility will search and list all UA/BRK/UA-IO modules in the network.

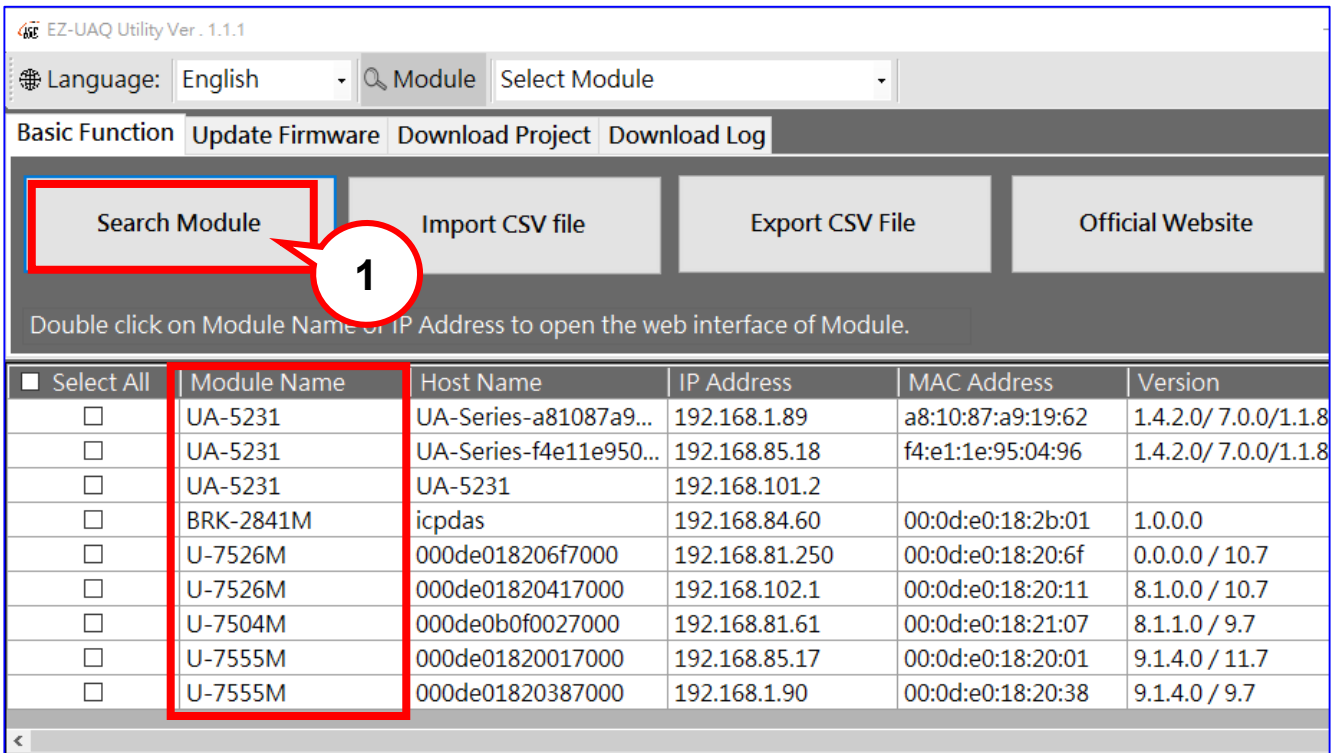

## 3. Connect to the UA Series

Double click the module list (from the Module Name to the IP address) you want to connect to, and it will directly link to the UA/BRK/UA-IO webpage via the default Web browser (Chrome, Edge, IE...).

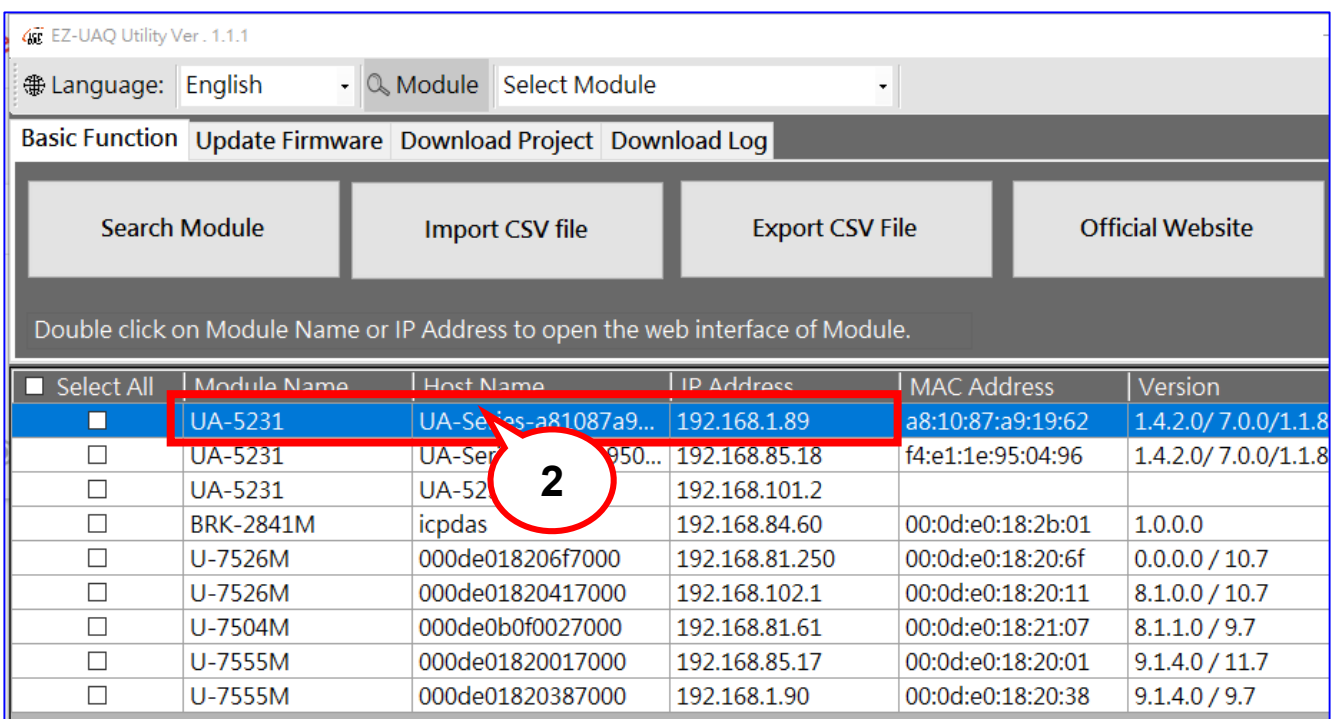

#### 4. Connection to the UA Web UI

The default web browser will be run and direct go to the UA login web site. Please enter the username and password to login the UA series Web UI.

The factory default username: **root**. The factory default password: **root**. After login in, change the default Username/password first, or user cannot use any other function (New design for data security).

#### 5. Login the Web UI of the UA Series

When login into the web interface, the UA default home page (the main configuration screen) will as below, and will automatically read setting of that UA to the webpage.

<a href="#">System Setting</a> <a href="#">Module Setting</a> <a href="#">IoT Platform Setting</a> <a href="#">Convert Setting</a> <a href="#">Advanced Setting</a> <a href="#">Logger Setting</a>																					
<a href="#">I/O Status</a> <a href="#">File Setting</a>																					
<a href="#">System Setting</a>																					
<a href="#">Controller Service Setting</a> <a href="#">Time Setting</a> <a href="#">Network Setting</a> <a href="#">Account Setting</a> <a href="#">Boot</a> <a href="#">COM Port Interface Setting</a> <a href="#">Web Secure</a>	<h3>Version Information</h3> <table border="1"> <tr> <td>Firmware Version</td> <td>Version 1.4.0.5</td> </tr> <tr> <td>Main Program</td> <td>Version 1.1.73</td> </tr> <tr> <td>Web Interface</td> <td>Version : 6.8.0 Date : 2022/05/18</td> </tr> <tr> <td>Flash Information</td> <td>eMMC Flash</td> </tr> </table> <h3>System Setting</h3> <table border="1"> <tr> <td>Controller Service Setting</td> <td>Controller Service Setting provides the function to display and set the running status of the controller service about the project, MQTT broker and DDNS.</td> </tr> <tr> <td>Time Setting</td> <td>Time Setting provides the function to display and set the date, time and time zone of the controller. (Include manually, synchronization, etc.)</td> </tr> <tr> <td>Network Setting</td> <td>Network Setting provides the function to display and set the network settings. (Include IP, host controller, DDNS, etc.)</td> </tr> <tr> <td>Account Setting</td> <td>Account Setting provides the function to set the username and password of the web UI.</td> </tr> <tr> <td>Boot</td> <td>Boot function provides the function to reboot the controller, and enable the function to run the project, MQTT broker or DDNS at startup.</td> </tr> <tr> <td>COM Port Interface Setting</td> <td>COM Port Interface Setting allows display and set the COM port interface of the controller for the RS-232/RS-485 serial communication.</td> </tr> </table>	Firmware Version	Version 1.4.0.5	Main Program	Version 1.1.73	Web Interface	Version : 6.8.0 Date : 2022/05/18	Flash Information	eMMC Flash	Controller Service Setting	Controller Service Setting provides the function to display and set the running status of the controller service about the project, MQTT broker and DDNS.	Time Setting	Time Setting provides the function to display and set the date, time and time zone of the controller. (Include manually, synchronization, etc.)	Network Setting	Network Setting provides the function to display and set the network settings. (Include IP, host controller, DDNS, etc.)	Account Setting	Account Setting provides the function to set the username and password of the web UI.	Boot	Boot function provides the function to reboot the controller, and enable the function to run the project, MQTT broker or DDNS at startup.	COM Port Interface Setting	COM Port Interface Setting allows display and set the COM port interface of the controller for the RS-232/RS-485 serial communication.
Firmware Version	Version 1.4.0.5																				
Main Program	Version 1.1.73																				
Web Interface	Version : 6.8.0 Date : 2022/05/18																				
Flash Information	eMMC Flash																				
Controller Service Setting	Controller Service Setting provides the function to display and set the running status of the controller service about the project, MQTT broker and DDNS.																				
Time Setting	Time Setting provides the function to display and set the date, time and time zone of the controller. (Include manually, synchronization, etc.)																				
Network Setting	Network Setting provides the function to display and set the network settings. (Include IP, host controller, DDNS, etc.)																				
Account Setting	Account Setting provides the function to set the username and password of the web UI.																				
Boot	Boot function provides the function to reboot the controller, and enable the function to run the project, MQTT broker or DDNS at startup.																				
COM Port Interface Setting	COM Port Interface Setting allows display and set the COM port interface of the controller for the RS-232/RS-485 serial communication.																				
© ICP DAS Co., Ltd. All Rights Reserved																					

### 3. Quick Start 2: Web UI / Setting Steps

This chapter introduces the UA Web User Interface (UI), the steps for project / function / list settings, and a project example. For more project examples please see [Chapter 4](#). The detail parameters of the menus, functions, etc. will introduce in the next chapters [Chapter 5](#).

First, login the UA Web UI as below. (**Default username/password: root/root**)

If your UA controller is not connect to the network yet, please refer to [Chapter 2](#).

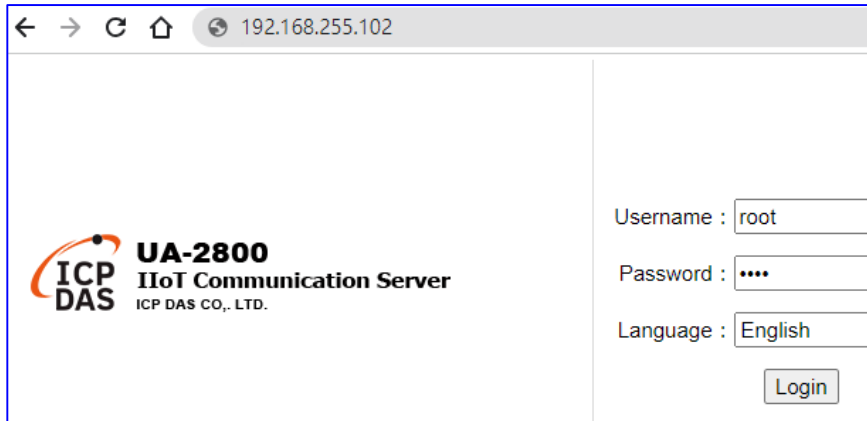

After log in the Web UI, users can see the version information, including the version of the install Firmware program, main program and Web Interface (and date).

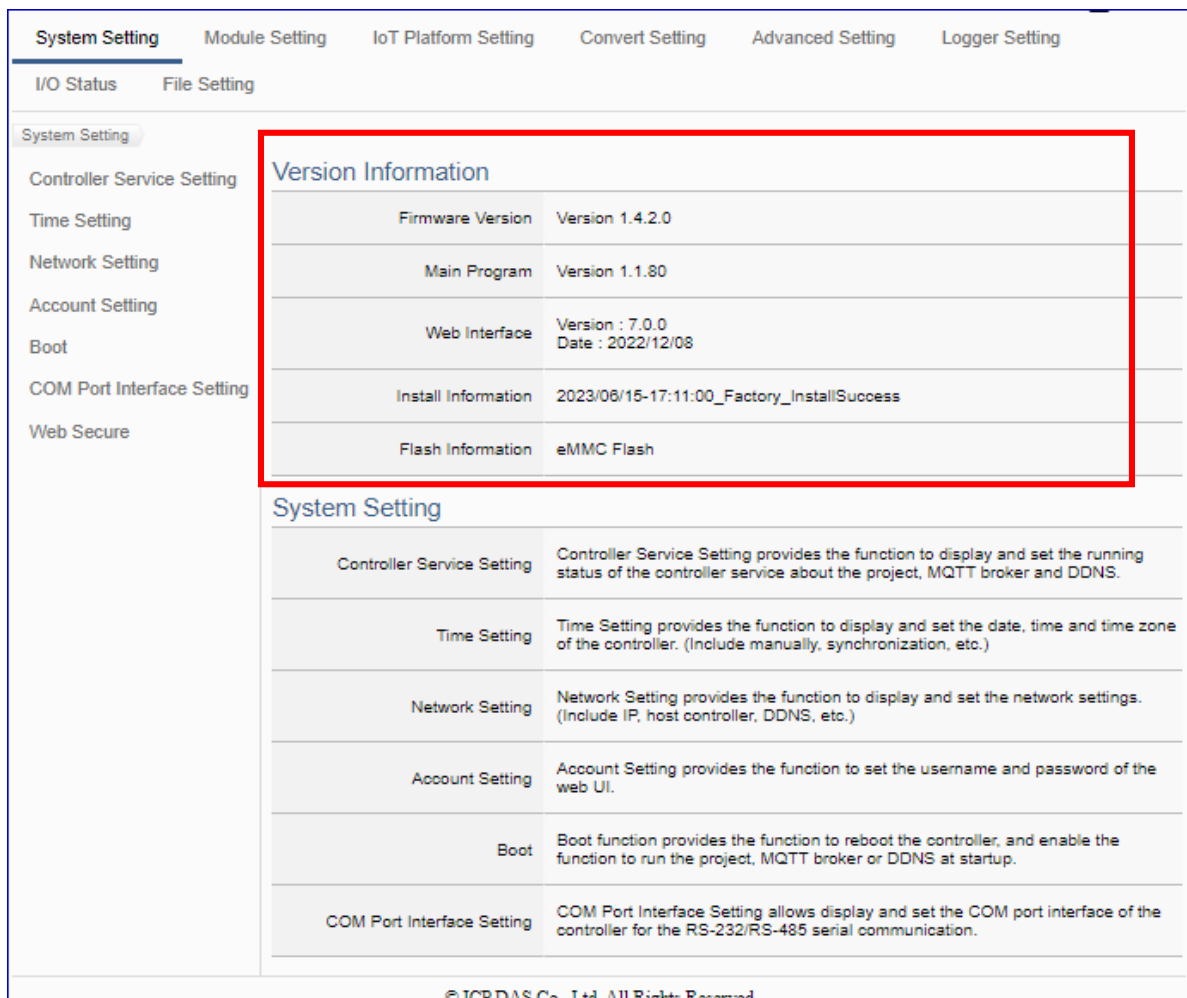

## 3.1 Web UI Environment Overview

### The function areas of the Web UI:

This chapter will overview these areas. The following chapters will introduce the settings of the functions and parameters.

1. **Function Wizard:** A quick setup area for commonly used projects or functions. The Web UI will enable a Wizard mode and show a “Step Box”. The user just follows the “Step Box” step-by-step and then can complete the project quickly and rightly. (Refer to [Chapter 4](#))
2. **Main Menu Area:** The main menu contains all the setting functions that classified into several categories. Click the main menu item, the sub-menu will appear on the left of the page, and the function descriptions will appear under the main menu area. (Refer to [Chapter 5](#))
3. **Sub-Menu Area:** The sub-menu will display detailed functions under the selected main menu. The user could setup or review detailed function options in the setting area. (Refer to [Chapter 5](#))
4. **Setting Area:** The setting area is for displaying and setting the functions and parameters of UA series controller. The content of this area will be vary according to the selected main menu and sub-menu.

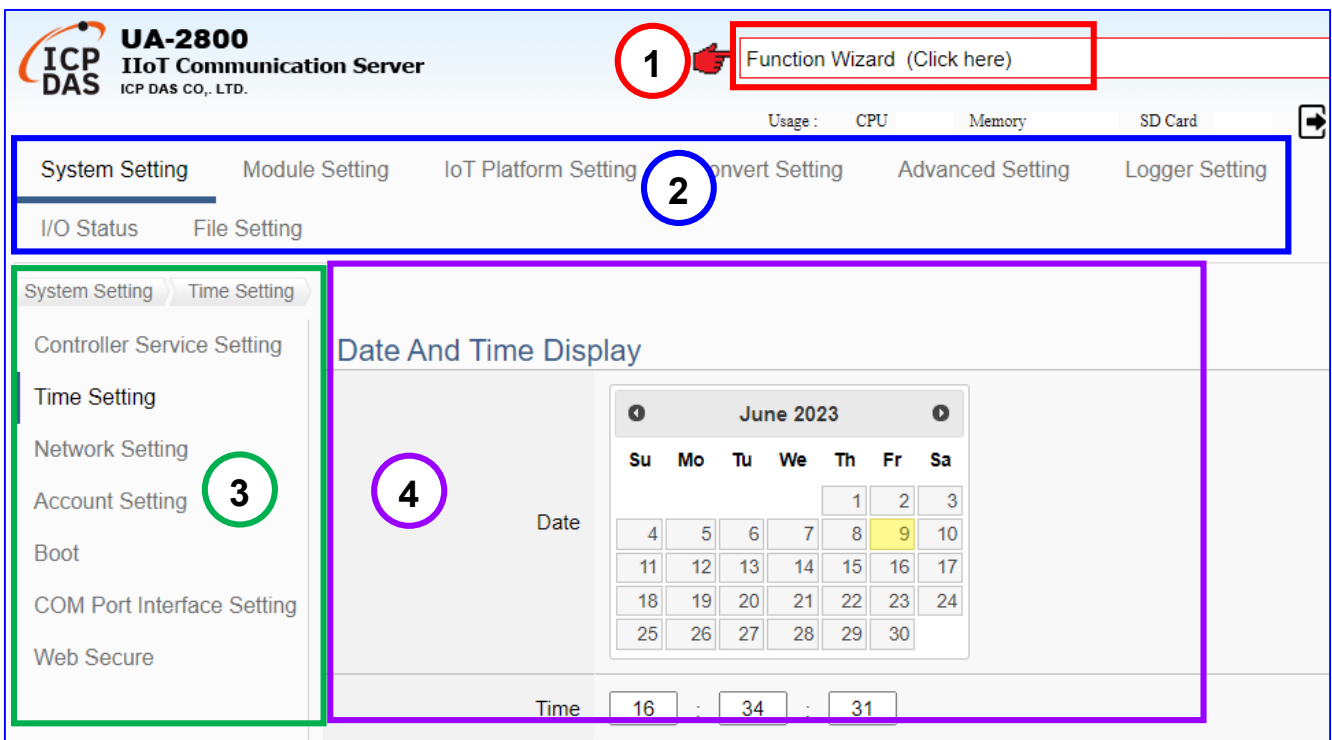

### 3.2 Setting Steps for Project / List

- **【Project Setting Steps】 :**

The setting for UA series controller is to set up from the left to the right of the main menu functions. The **“Function Wizard”** even provides the **“Step Box”** for users to follow the steps and prevent from selecting the wrong function.

The Web UI screen of UA Series is as following; User can set up own UA project. If user has not login your UA Web UI, refer to [CH2 Quick Start 1](#).

**CH4 [Function Wizard]:** In the upper right corner of the web UI, to guide users quickly set up a project. It provides many quick setting option items. With the step-by-step guide of the function wizard, the project can be completed quickly. Please see [Chapter 4](#).

**CH5 [Main Menu]:** The user can also select the function of the main menu to set projects by himself. For the detailed function and parameter descriptions, please refer to [Chapter 5](#).

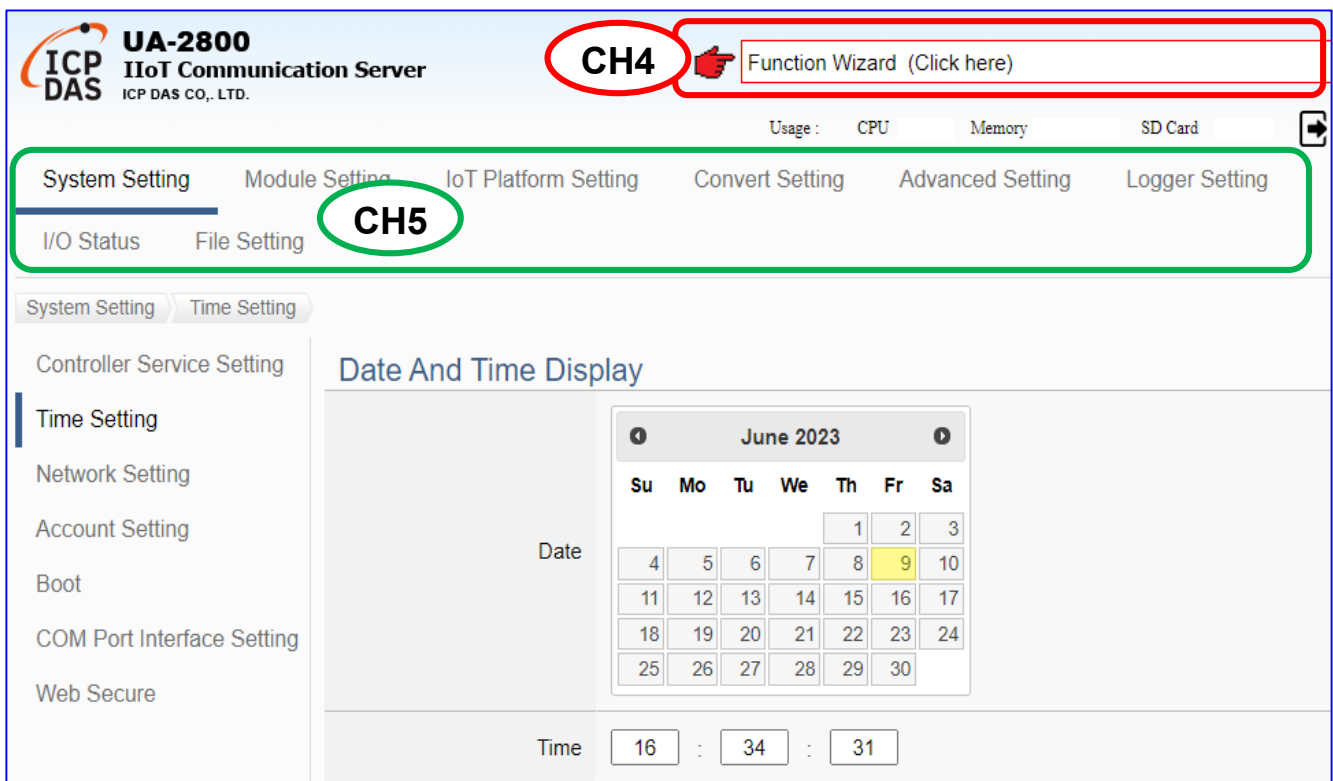

**For Example:** the setting steps of the Modbus communication conversion with the OPC UA protocol are as below:

**Steps for setting the Project:**

Controller Setting > Module Setting > Connecting OPC UA (in IoT Platform) > Conversion > File Setting > Execution

**Main Menu:**

System Setting    Module Setting    IoT Platform Setting    Convert Setting    Advanced Setting    I/O Status    File Setting

**Function Wizard Step Box: (EX. Modbus RTU <=> OPC UA)**

Controller COM Port Setting > Module Setting > OPC UA Connection > Enable Converting Module > Save Project >

Run the project

Click the **Function Wizard** and select the “**(Master) Modbus RTU <=> OPC UA**” item.

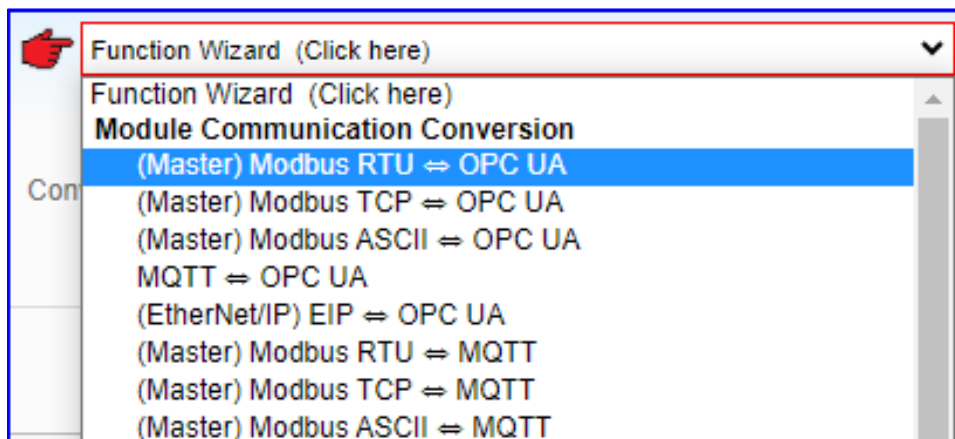

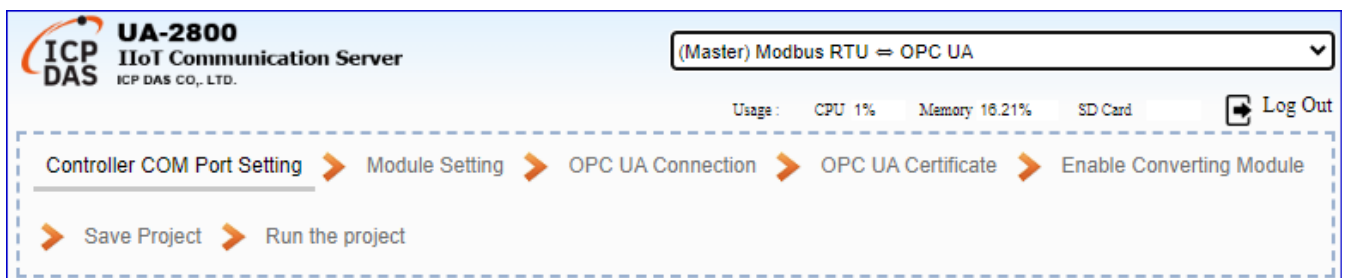

The Web UI will enable a Wizard guide and show a “**Step Box**” (as below picture). The user just needs to follow the “Step Box” step-by-step and then can complete the project quickly and correctly.



● **【 List Setting Steps 】 :**

In the steps of setting up the project, various lists need to be set up, including: modules, connections, I/O channels, variables, communication connections, database... etc. About the List setting of module, connection..., they have the similar steps as below.

**Steps for Setting List:**

1. Select the connection **port** for the module (or connection...)
2. Click the icon  to switch the mode(Name/Select The Module) to add a new module:  
**Name:** give a name, then click the button  to add a list of module, connect...  
**or Select The Module:** Select an ICP DAS module/list (For Modbus RTU/TCP)
3. Click the button **[Edit]** to enter the Content Setting page. Set up the list content.
4. Click **[Save]** to back, and then [Save] the list page.

**Steps for List:** e.g. Modbus RTU Module List.

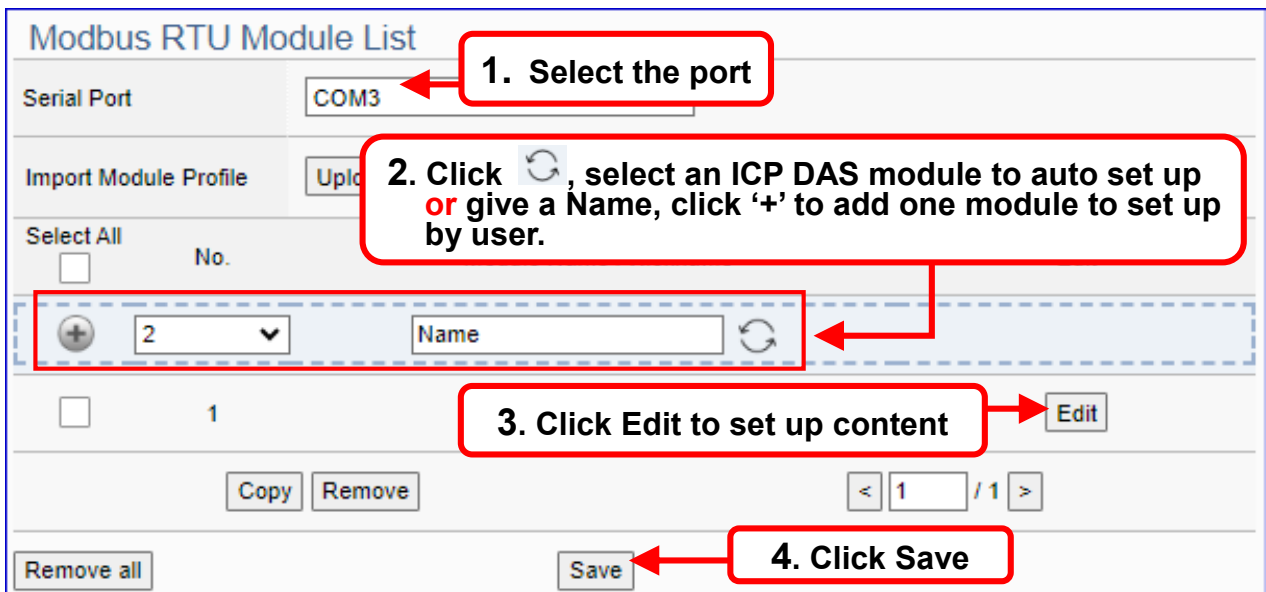

The next chapter [4.Function Wizard: Project Quick Setup](#) will provide various **examples** about setting the commonly projects and functions.

### 3.3 Project Setting – A Quick Setup Example

This example will setup a project for conversion of OPC UA and Modbus RTU (Master) communication protocol using the Function Wizard. The devices include a UA-2841M controller and an M-7055D module that wired with RS-485 interface to read/write the Modbus RTU I/O data and need the convert setting. The wiring is show as the picture below.

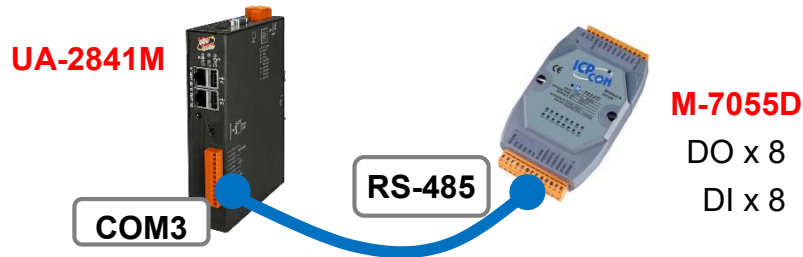

**Note:** 【Function Wizard】 at the up-right corner of the Web UI is a quick setup area. The hardware/network connection methods please see the [CH. 2](#) .

This sample uses the conversion function of the Function Wizard to convert the Modbus RTU / OPC UA. First, click the “(Master) Modbus RTU / OPC UA” item of the Function Wizard.

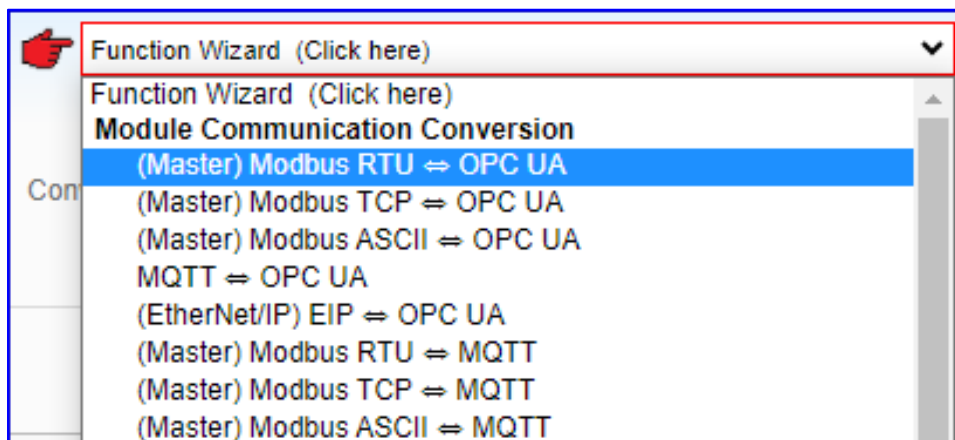

The Web UI will enable a Wizard guide mode and show a “Step Box” (as below picture). The user just needs to follow the “Step Box” step-by-step and then can complete the project quickly and correctly.

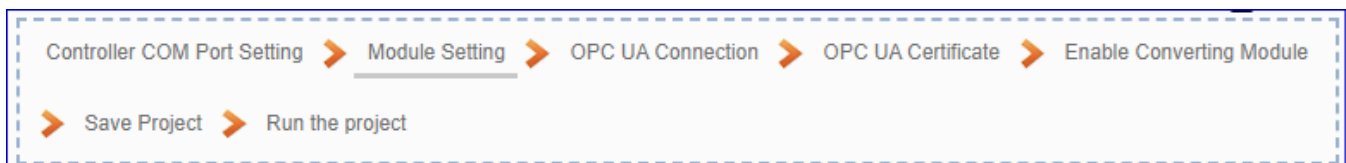

After click the **[(Master) Modbus RTU <=> OPC UA]** , follow the “**Step Box**” to complete the 7 steps: (The step with a **bold underline** means it is the current step.)

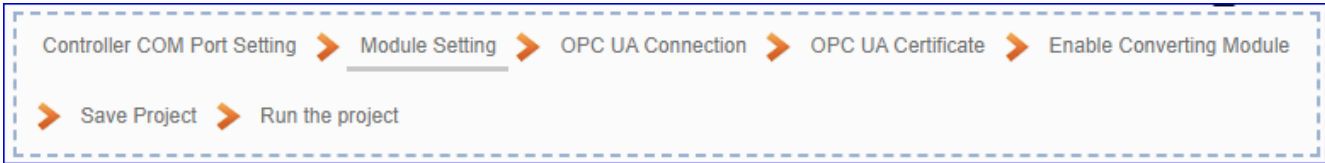

● **Step 1. Controller COM Port Setting**

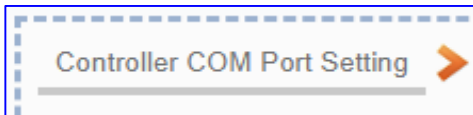

This step sets up the COM port interface of the UA controller to connect with the module and the communication setting.

**<This Example>**

The UA uses the COM3 port to connect with the M-7055D, so set the **Serial Port: COM3**. The M-7055D module default setting is “9600, 8, N, 1”, so set **Baud Rate: 9600, others need not to change**. After setting, click [Save] button to store this page setting. (The user also can save the whole project until the step of “Save Project”.)

**Note:** If user uses other port to link other module, or the module is not in the default state, please set this step according to your case. The user can find the M-7055D default state in the Module CD or its [Product Web Site](#) .

System Setting		Module Setting	IoT Platform Setting	Convert Setting	Advanced
I/O Status		File Setting			
System Setting		COM Port Interface Setting			
Controller Service Setting		<b>COM Port Interface Setting Page</b>			
Time Setting		Serial Port	COM3		
Network Setting		Baud Rate	9600		
Account Setting		Data Bits	8 bits		
Boot		Parity	None		
COM Port Interface Setting		Stop Bits	1 bit		
		Polling Rate(ms)	500		
		Save			

● **Step 2. Module Setting**

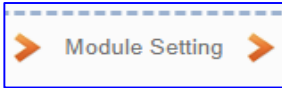

Click the next step, and enter the **Step 2 [Module Setting]** of the UI setting.

This step is for setting the connected modules. The user can set each module a name (Default name: Name), click [ + ] button to create a new module, and click [Edit] button to configure the module content and Modbus mapping table.

**<This Example>**

In “Module Setting”, select the **Serial Port: COM3**, and select **ICP DAS Module: M-7055D**, the system will auto setup the ICP DAS module. If not use ICP DAS module, please give a name and click the button [ + ] to add a Module List.

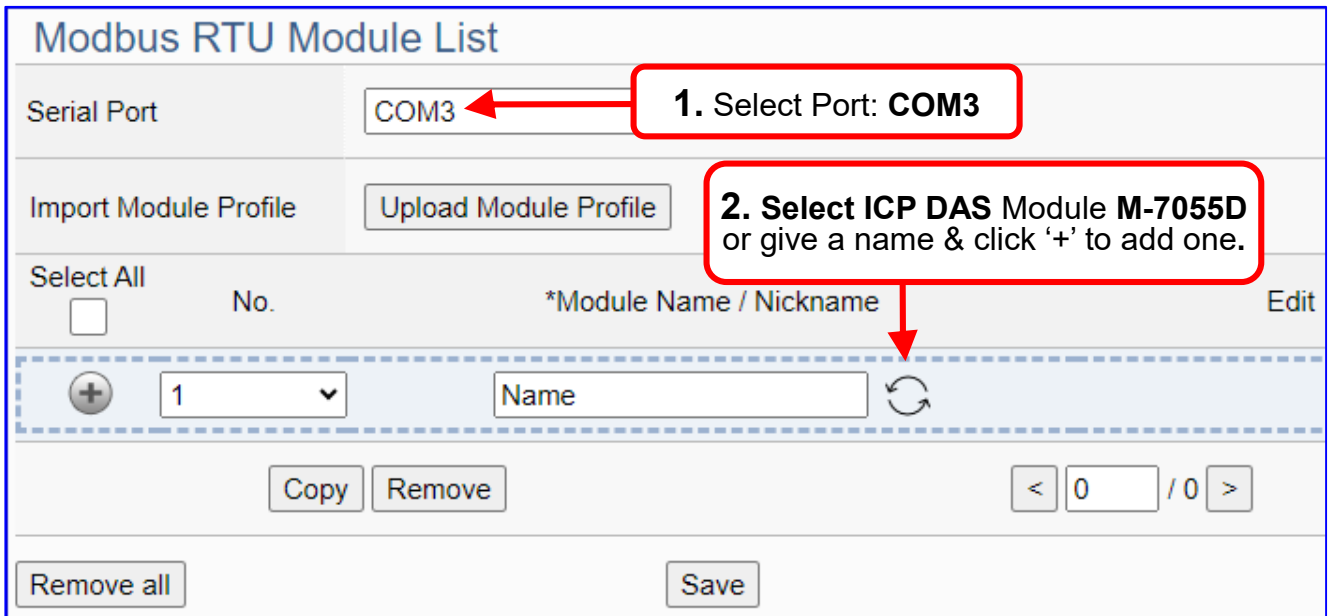

Add a module M-7055D as below, and then click [Edit] button to enter the “Module Content Setting” page.

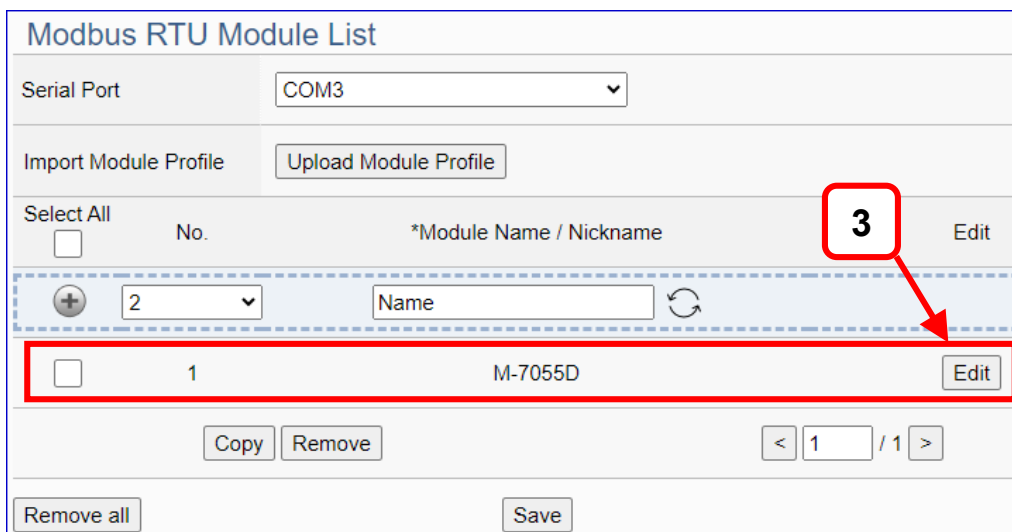

[Module Content Setting] page can set the module and its Modbus mapping table.

**If use ICP DAS module, system will auto-setup the module and its Modbus Mapping Table.** Such as this example, we select the module from “Load ICP DAS Module”, it auto-shows the M-7055D (DO x 8, DI x 8) module content and Modbus Mapping Table as below.

### Module Content Setting

No.	<input type="text" value="1"/>
Module Name	<input type="text" value="M-7055D"/>
Slave ID	<input type="text" value="1"/>
Timeout(ms)	<input type="text" value="500"/>

### Modbus Mapping Table Setting

Data Model	<input type="text" value="01 Coil Status(0x)"/>
Start Address	<input type="text" value="0"/>
Data Number	<input type="text" value="1"/>
Create Tables	<input type="button" value="Add"/>

### Modbus Mapping Table

		Address	Nickname	Scaling	Bitwise															
Coil Status(0x)	Input Status(1x)	Holding Registers(4x)																		
<table border="1" style="width: 100%; border-collapse: collapse;"> <tr><td style="background-color: #e0e0e0;">Address</td><td>0</td></tr> <tr><td style="background-color: #e0e0e0;">Number</td><td>8</td></tr> <tr><td style="background-color: #e0e0e0;">Type</td><td>Bool</td></tr> <tr><td colspan="2" style="text-align: right;"><input type="button" value="Edit"/></td></tr> </table>	Address	0	Number	8	Type	Bool	<input type="button" value="Edit"/>		<table border="1" style="width: 100%; border-collapse: collapse;"> <tr><td style="background-color: #e0e0e0;">Address</td><td>0</td></tr> <tr><td style="background-color: #e0e0e0;">Number</td><td>8</td></tr> <tr><td style="background-color: #e0e0e0;">Type</td><td>Bool</td></tr> <tr><td colspan="2" style="text-align: right;"><input type="button" value="Edit"/></td></tr> </table>	Address	0	Number	8	Type	Bool	<input type="button" value="Edit"/>				
Address	0																			
Number	8																			
Type	Bool																			
<input type="button" value="Edit"/>																				
Address	0																			
Number	8																			
Type	Bool																			
<input type="button" value="Edit"/>																				

**If not use ICP DAS Module**, please check the module’s user manual to find out the module Modbus Address, and refer to the chapter “Module Setting” of the UA manual as below.

Please set up the addresses mapping with the module I/O channels in the [**Modbus Mapping Table Setting**]. The system provides 4 Modbus data models (as below) “01” to “04” for mapping to the **DO, DI, AO and AI** channels.

01 Coil Status(0x)
02 Input Status(1x)
03 Holding Registers(4x)
04 Input Registers(3x)

**Note:** the start address of UA series is bass on “0”. Some modules start address are bass on “1”, but please note UA is follow the rule of start address “0”, and set enough Data Number for mapping to the I/O channels of the linking module.

In this example, M-7055D has 8 DO and 8 DI channels, please create the table as following pictures of the [**Modbus Mapping Table Setting**]. After complete the setting, the DO and DI Modbus address settings will show in the [**Modbus Mapping Table**].

M-7055D **8 DO** setting (left) and the [**Coil Status(0x)**] table after setting (right):

**Modbus Mapping Table Setting**

**DO mapping 01** → Data Model: 01 Coil Status(0x)

**UA start address: 0** → Start Address: 0

**DO x 8** → Data Number: 8

**Click [Add]** → Create Tables: Add

**Coil Status(0x)**

Address	0
Number	8
Type	Bool

Edit

M-7055D **8 DI** setting (left) and the [**Input Status(1x)**] table after setting (right):

**Modbus Mapping Table Setting**

**DI mapping 02** → Data Model: 02 Input Status(1x)

**UA start address: 0** → Start Address: 0

**DI x 8** → Data Number: 8

**Click [Add]** → Create Tables: Add Success.

**Input Status(1x)**

Address	0
Number	8
Type	Bool

Edit

The Modbus Mapping table is showing as below. Click [OK] to save and exit.

Modbus Mapping Table		Address	Nickna
Coil Status(0x)			
Address	0		
Number	8		
Type	Bool		
Edit			
Input Status(1x)			
Address	0		
Number	8		
Type	Bool		
Edit			

For more setting item descriptions, please refer to chapter [Chapter 5.2. Module Setting](#).

● **Step 3. OPC UA Connection**

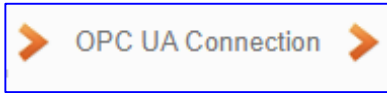

Click the next step, and enter the **Step 3 [OPC UA Connection]** of the UI setting

This step is for setting the IoT platform and the OPC UA connection, e.g. the server name, port, login identity information, etc.

We select the “Modbus RTU / OPC UA” conversion at the beginning, so this step will auto enter the **[OPC UA Connection > Local Server]** page of IoT Platform Setting. The “Step Box” will prevent the user from selecting the wrong platform.

**<This Example>**

The server name and port of **[OPC UA Connection]** will auto show up, user needs not to change in this example, but can change the port if needs.

The Anonymous Login default enables, you need not to change in this example. At last, click **[Save]** button.

System Setting	Module Setting	<b>IoT Platform Setting</b>	Convert Setting	Advanced Setting
I/O Status	File Setting			
IoT Platform Setting		Local Server		
<b>MQTT Connection</b>		<b>Server</b>		
Local Broker		Server Name <input type="text" value="ICPDAS_OPC_UA_Server"/>		
Remote Broker		Port <input type="text" value="48010"/>		
MQTT Group Connection		<input type="button" value="Save"/>		
Microsoft Azure Platform				
<b>OPC UA Connection</b>		<b>User Identity Tokens</b>		
Local Server		Anonymous Login <input checked="" type="checkbox"/> Enabled		
		User Password Login <input checked="" type="checkbox"/> Enabled		
		Certificate Login <input type="checkbox"/> Enabled		
		<input type="button" value="Save"/>		

For enabling other logins, please see the **[OPC UA Connection]** in the [Chapter 5.3 IoT Platform Setting](#) .

● **Step 4. OPC UA Certificate**

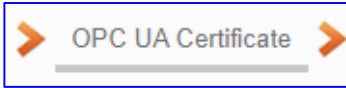

Click the next step, and enter the **Step 3 [OPC UA Certificate]** of the UI setting. This step is about setting the OPC UA Certificate for the security and encryption, e.g. upload, download, remove certificate. **If user's project does not need to use the secure encryption connection, please skip this step and click the next step directly.**

The connected **Server/Client** adds the certificate to each other for secure encryption:

- ① Get the Trusted Certificate file from the connecting **OPC UA Client** and save it in the PC. In this step, select the file and upload it to the UA controller.
- ② Provide the **OPC UA Server** certificate of this UA controller to the Client device. In this step, **download** the certificate file (**Certicate\_IPAddress\_.tar**), decompress it (**icpdasuaserver.der**) and upload it to the client device.

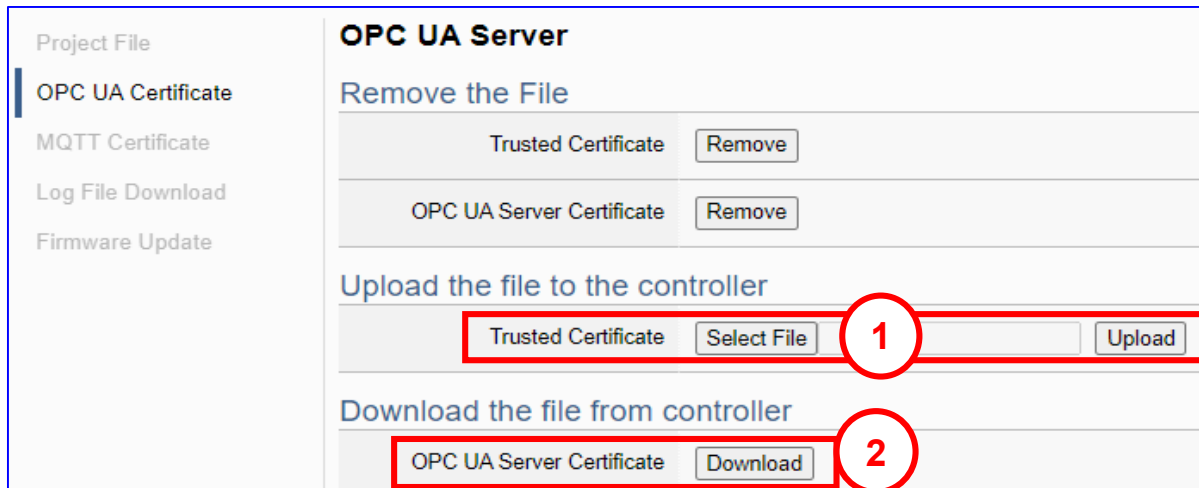

File Setting > OPC UA Certificate > Upload the file to the controller	
Trusted Certificate	<p><b>Select File:</b> select the OPC UA Trusted Certificate file in PC to upload to the UA controller.</p> <p><b>Upload:</b> upload the Trusted Certificate file to the UA controller.</p> <ul style="list-style-type: none"> <li>• File format must be <b>DER</b>. Extension name must be <b>“der / cer / crt”</b>.</li> </ul> <div style="border: 1px solid #ccc; padding: 5px; margin-bottom: 5px;"> <span>Trusted Certificate</span> <span>Select File</span> <input type="text" value="icpdasuaserver.der"/> <span>Upload</span> </div> <ul style="list-style-type: none"> <li>• If select a wrong file, the system will show an error message.</li> </ul> <div style="border: 1px solid #ccc; padding: 5px;"> <span>Trusted Certificate</span> <span>Select File</span> <input type="text" value="Certificate_192.168.255.10"/> <span style="color: red;">Certificate type is wrong.</span> <span>Upload</span> </div>
File Setting > OPC UA Certificate > Download the file from controller	
OPC UA Server Certificate	<p><b>Download:</b> Download the OPC UA Server Certificate file to the current using computer.</p> <ul style="list-style-type: none"> <li>• File format: <b>DER</b>. File name: <b>Certicate_IP-address_.tar</b></li> </ul> <p>e.g.  <input type="text" value="Certificate_192.168.255.102.tar"/></p> <p>Before using, decompress to <b>icpdasuaserver.der</b>, as below.</p> <div style="border: 1px solid #ccc; padding: 5px; margin-top: 5px;"> <input type="text" value="icpdasuaserver.der"/> </div>

For more settings, refer to the [5.8.3 OPC UA Certificate] in the [Chapter 5.8 File Setting](#) .

● **Step 5. Enable Converting Module**

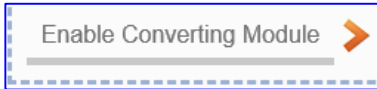

Click the next step, and enter the **Step 5 [Enable Converting Module]** UI setting

This step is for enabling the Modbus RTU / OPC UA conversion.

This step will auto enter the [**OPC UA > Modbus RTU (Master)**] page of Conversion setting because we select the “Modbus RTU / OPC UA” conversion at the beginning. The “Step Box” will prevent the user from selecting the wrong platform.

**<This Example>**

In this setting page, please **check** the enable box of the module **M-7055D** we set up in the previous steps. Then click [Save] button.

The above action will enable all I/O channels of the M-7055D for communication conversion. If users need to enable some channels only, please click [Edit] to enable individual channels. (Refer to [Chapter 5.4](#))

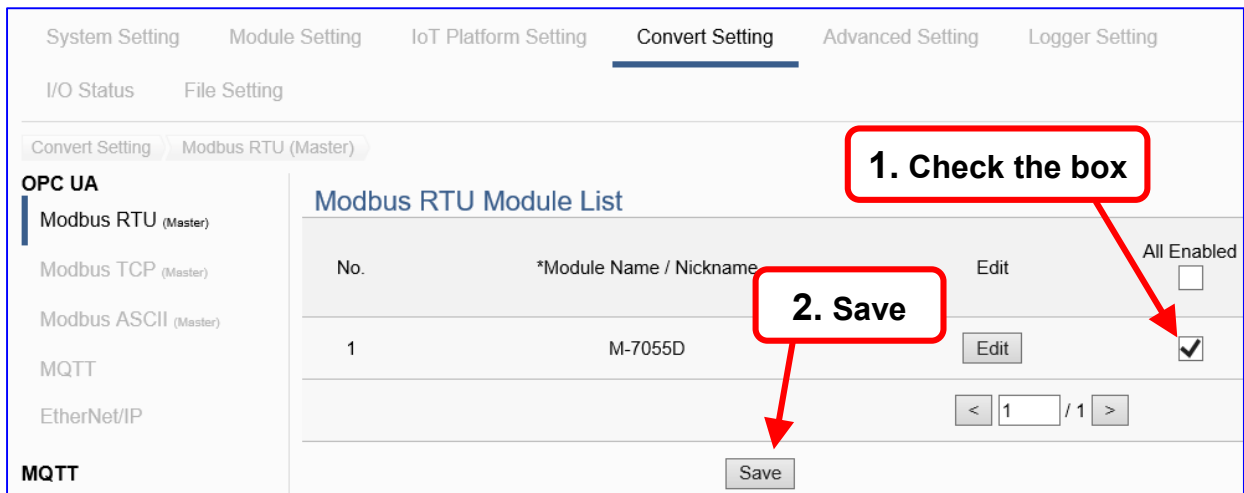

● **Step 6. Save Project**

The setting of this example is finished now. Click the next step **[Save Project]**, the Step Box will show an animation as below picture, that means the project is saving. When the animation disappears, the project is saved completely.

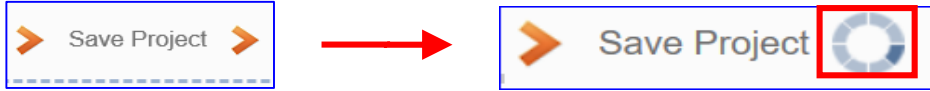

● **Step 7. Run the Project**

The project, after saving, needs to be executed. Click the next step **[Run the Project]**. This step can also via the **[System Setting > Controller Service Setting > Run Project]** to Stop and Run the project.

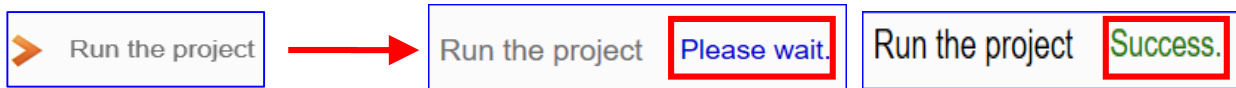

When the words **“Please wait”** disappears, the new words **“Success”** appears, that means the UA controller is running new project successfully. Then the Step Box will disappear automatically now, and back to the first screen view of the Web UI.

The new project now completes the setting, uploading and running in the UA controller and can process the conversion communication. Users can see the I/O status from the menu **[I/O Status]**. For more about the Web UI settings, please refer to CH4 and CH5.

I/O Status
File Setting

I/O Status

**Modbus RTU Module (Master)**

No.	Name	Serial Port
1	M-7055D	ttyO5

/ 1

**Modbus TCP Module (Master)**

No.	Name	LAN
1	DL-302	LAN

**Related Settings**

Number of variables	<input type="text" value="10"/>	(Updated 10 points per second)
Display Update Time (ms)	<input type="text" value="1000"/>	

**I/O Status**

Variable Name	Data Type	Value	Description
<input type="text" value="DI0"/>	Bool	<input type="checkbox"/>	<input type="text"/>
<input type="text" value="DI1"/>	Bool	<input type="checkbox"/>	<input type="text"/>

40

## 4. Function Wizard: Project Quick Setup

Chapter 4 is about the UA project setup. [Function Wizard] in the up-right corner of the Web UI provides an **easy and quick** setting “Step Box” that **very suitable for the new users**.

[Function Wizard Step Box]  
(abbreviation [Step Box])

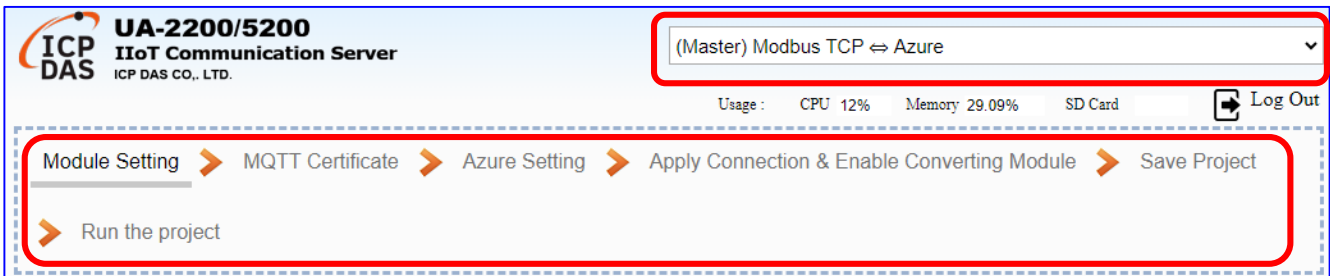
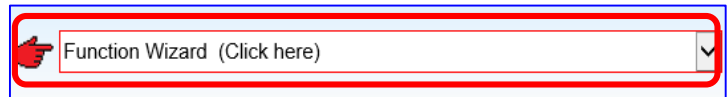

Step Box is a step guide of the Function Wizard. When users select an item, the Web UI will enable a Wizard and show a “Step Box” for user to follow the “Step Box” step-by-step and then can complete the project easily & quickly.

This chapter introduce the Function Wizard category and items, the examples for setting steps of the projects/functions are on the FAQ Webpage. There are several **categories (in red box, they also are the FAQ Category)** and items in each section. We will develop more items in the future.

When set up the project, please choose an item from a category and follow the steps. Please at least refer one example in this chapter to know the setting steps and tips.

All **setting examples** of most used Function Wizard items are put on the UA series FAQ website. Please refer to **ICP DAS homepage > Support > Product FAQ > IICoT > UA series > Communication Server > UA FAQ – Function Wizard**.

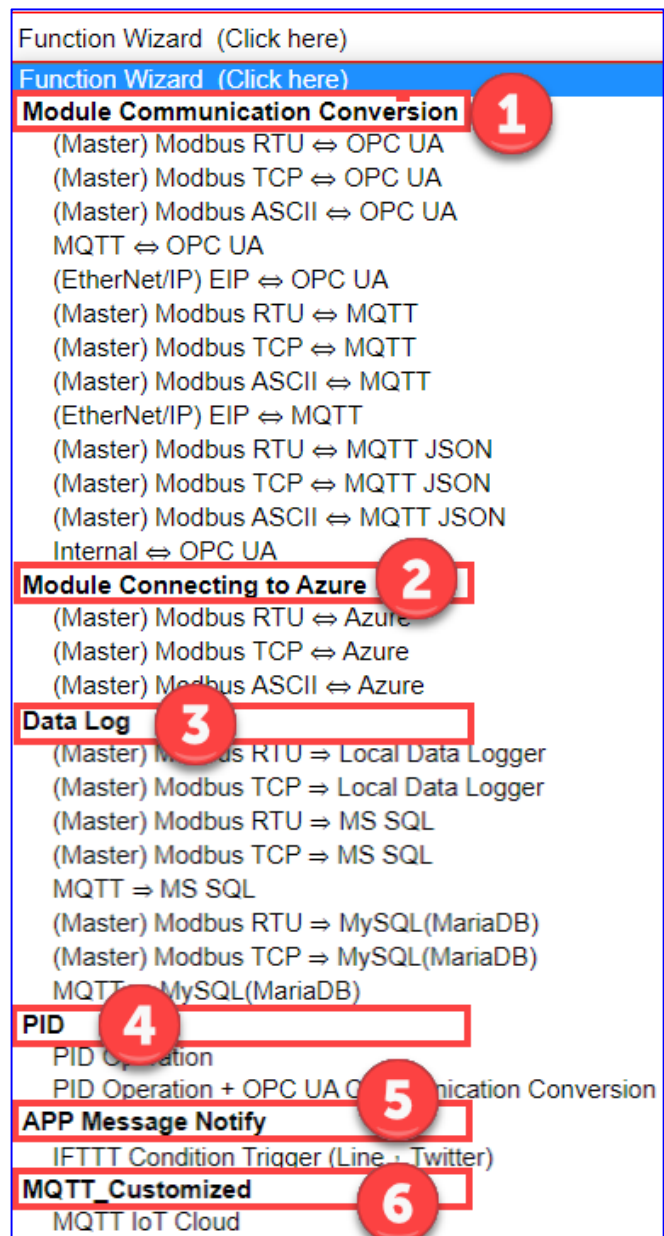

Example FAQ of Function Wizard as following:

1. Enter **ICP DAS Homepage** > **SUPPORT** > **Production FAQ** web page
2. On the left side menu, click the **IIoT** of the Product FAQ
3. Select **UA Series** > **Communication Server**
4. Select the “+” icon on the right side of the **UA FAQ-Function Wizard**, find the Category and Item you want.
5. Click the “**Use Module Name**” of the FAQ you need to see the example.

UA FAQ Web Page: <https://www.icpdas.com/en/faq/index.php?kind=326#950>

The screenshot shows the ICP DAS website interface. The navigation path is: HOME > SUPPORT > Product FAQ > IIoT > UA Series > Communication Server. The 'SUPPORT' menu item is highlighted with a green box and a callout '1'. In the left sidebar, 'IIoT' is highlighted with a green box and callout '2', and 'UA Series' is highlighted with a green box and callout '3'. The main content area shows a table of subjects with 'UA FAQ - Function Wizard' highlighted by a green box and callout '4'. Below this, there is a question 'A How to set up the UA project by Function Wizard of the UA Web UI?' and a screenshot of the 'Function Wizard' interface. At the bottom, a table lists 'Function Wizard FAQ - Category & Item' with 'Use M-7055D' highlighted by a green box and callout '5'.

SUBJECT	VIEWS	FAQ TYPE	MODEL	LAST UPDATED	DETAIL
UA FAQ - Function Wizard	172	Software Development		2021-10-28	-

  

No.	Function Wizard FAQ - Category & Item	PDF
[ Module Communication Conversion ]		
cnv-1	Modbus RTU / OPC UA Modbus ASCII / OPC UA	<a href="#">Use M-7055D</a> (With instructions for verifying OPC UA)
cnv-2	MQTT / OPC UA	<a href="#">Use MQ-725D</a>

## 4.1 [Module Communication Conversion] Category

“Module Communication Conversion” of UA series, a very commonly used function, can effectively communicate the IoT devices or systems (e.g. cloud, database...) with I/O data of the module (e.g. Modbus module). This section will introduce the setting steps and the function parameters of the “Module Communication Conversion”. In the category, there are several items that can be divided into the following protocol types and will introduce them in the FAQ: OPC UA, MQTT, MQTT JSON, and Internal for virtual.

Module Communication Conversion
(Master) Modbus RTU ⇔ OPC UA
(Master) Modbus TCP ⇔ OPC UA
(Master) Modbus ASCII ⇔ OPC UA
MQTT ⇔ OPC UA
(EtherNet/IP) EIP ⇔ OPC UA
(Master) Modbus RTU ⇔ MQTT
(Master) Modbus TCP ⇔ MQTT
(Master) Modbus ASCII ⇔ MQTT
(EtherNet/IP) EIP ⇔ MQTT
(Master) Modbus RTU ⇔ MQTT JSON
(Master) Modbus TCP ⇔ MQTT JSON
(Master) Modbus ASCII ⇔ MQTT JSON
Internal ⇔ OPC UA

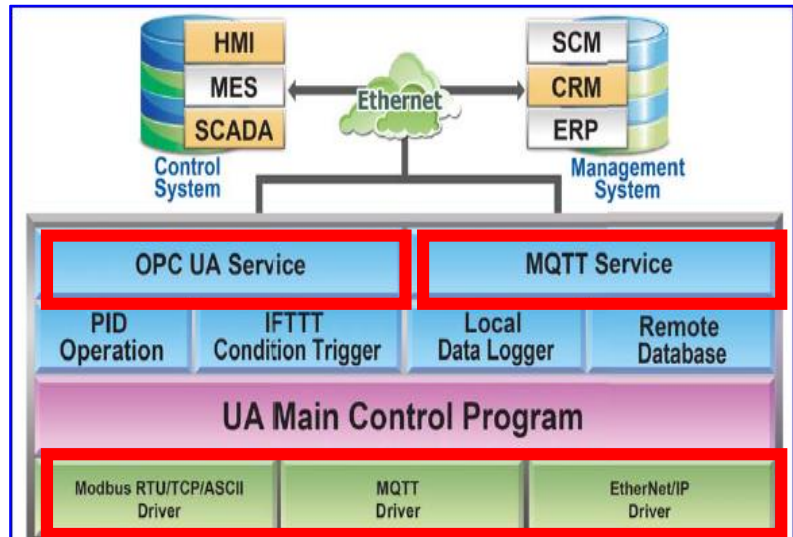

Item	Description
<b>Modbus RTU &lt;=&gt; OPC UA</b> <b>Modbus TCP &lt;=&gt; OPC UA</b> <b>Modbus ASCII &lt;=&gt; OPC UA</b>	Using the <b>OPC UA Service</b> to convert with <b>Modbus RTU/TCP/ ASCII</b> protocols.
<b>MQTT &lt;=&gt; OPC UA</b>	Using the <b>OPC UA Service</b> to convert with <b>EtherNet/IP</b> protocols.
<b>EIP &lt;=&gt; OPC UA</b>	Using the <b>OPC UA Service</b> to convert with <b>EtherNet/IP</b> protocols.
<b>Modbus RTU &lt;=&gt; MQTT</b> <b>Modbus TCP &lt;=&gt; MQTT</b> <b>Modbus ASCII &lt;=&gt; MQTT</b>	Using the <b>MQTT Service</b> to convert with <b>Modbus RTU/TCP/ ASCII</b> protocols.
<b>EIP &lt;=&gt; MQTT</b>	Using the <b>MQTT Service</b> function to convert with <b>EtherNet/IP</b> protocols.
<b>Modbus RTU &lt;=&gt; MQTT JSON</b> <b>Modbus TCP &lt;=&gt; MQTT JSON</b> <b>Modbus ASCII &lt;=&gt; MQTT JSON</b>	Using the <b>MQTT Service</b> function in-group of <b>JSON</b> format to convert with <b>Modbus RTU/TCP/ ASCII</b> protocols.
<b>Internal &lt;=&gt; OPC UA</b>	Using the <b>SNMP (Agent) Service</b> to convert with <b>Modbus RTU/TCP</b> protocols.
<b>Internal &lt;=&gt; OPC UA</b>	Using the <b>OPC UA Service</b> function to convert <b>Internal</b> to OPC UA (Server) protocol, or as an intermediary to provide <b>data exchange for OPC UA Client to Client.</b>

UA FAQ Web Page: <https://www.icpdas.com/en/faq/index.php?kind=326#950>

No.	Function Wizard FAQ	PDF / Attachment
<b>[ Module Communication Conversion ]</b>		
Cnv-01	Modbus RTU / OPC UA Modbus ASCII / OPC UA	<a href="#">Use M-7055D (With verifying OPC UA)</a>
Cnv-02	MQTT / OPC UA	<a href="#">Use MQ-7255M</a>
Cnv-03	(EtherNet/IP) EIP / OPC UA	<a href="#">Use EIP-2060</a>
Cnv-04	Modbus TCP / MQTT	<a href="#">Use DL-302</a>
Cnv-05	(EtherNet/IP) EIP / MQTT	<a href="#">Use EIP-2060</a>
Cnv-06	Modbus RTU / MQTT JSON Modbus ASCII / MQTT JSON	<a href="#">Use M-7055D</a>
Cnv-07	Internal / OPC UA	<a href="#">Data Exchange for OPC UA Client to Client</a>
Cnv-08	** / MQTT (JSON) -> AWS	<a href="#">Use MQTT to upload data to AWS</a>

## 4.2 [Module Connecting to Azure] Category

"Module Connecting to Azure" is a common way to integrate IoT devices into the cloud. Many of the applications use MQTT connection to the cloud for the setting is fast and easy. The UA series also provides the MQTT function for module to connect to the Azure platform and allows users to publish messages to Microsoft Azure and receive messages from Microsoft Azure.

Before setting the Azure connection, user needs to apply user **SAS Token** and **Root CA** from Microsoft Azure. This FAQ will introduce the setting steps and the function parameters. There are 3 items about Azure function in the "Function Wizard". All connections use the MQTT Service. Here will introduce the Modbus TCP / Azure.

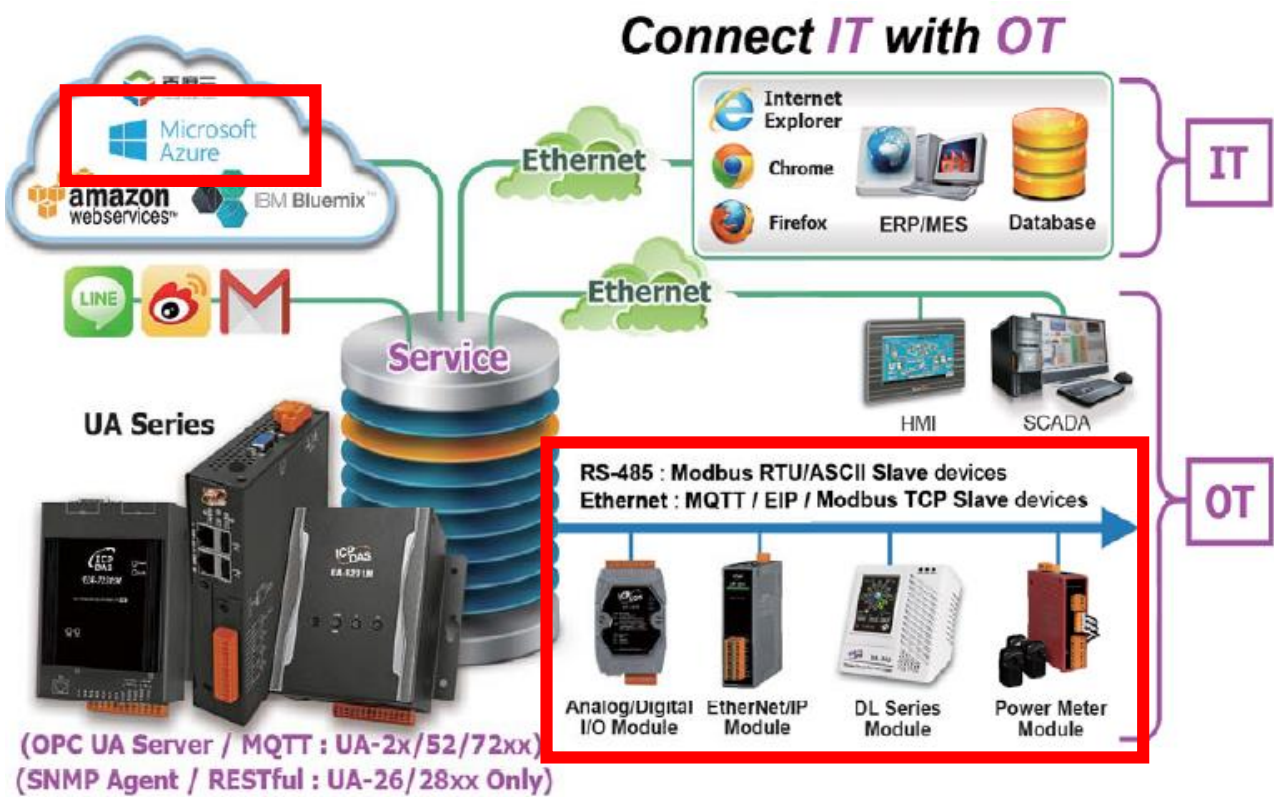

**Module Connecting to Azure**  
 (Master) Modbus RTU ⇔ Azure  
 (Master) Modbus TCP ⇔ Azure  
 (Master) Modbus ASCII ⇔ Azure

Item	Description
<b>Modbus RTU ⇔ Azure</b>	Allow the Modbus RTU connecting to the Microsoft Azure platform and can publish messages to Microsoft Azure and receive messages from Microsoft Azure.
<b>Modbus TCP ⇔ Azure</b>	Allow the Modbus RTU connecting to the Microsoft Azure platform and can publish messages to Microsoft Azure and receive messages from Microsoft Azure.

Item	Description
<b>Modbus ASCII &lt;=&gt; Azure</b>	Allow the Modbus RTU connecting to the Microsoft Azure platform and can publish messages to Microsoft Azure and receive messages from Microsoft Azure.

UA FAQ Web Page: <https://www.icpdas.com/en/faq/index.php?kind=326#950>

No.	Function Wizard FAQ - Item	PDF
<b>[ Module Connecting to Azure ]</b>		
azr-1	Modbus TCP / Azure	<a href="#">Use DL-302 [Attachment]</a>

### 4.3 [Data Log] Category

UA series supports Data Logger function. Its Local Data Logger can save I/O data log to local CSV file, and record I/O status at the scheduled time. Furthermore, users can set the time interval of which CSV file to generate and divide on the local side. Its Remote Database can import I/O data collection directly into the remote SQL database, e.g. MS SQL, MySQL, MariaDB ..., for the Big Data analysis.

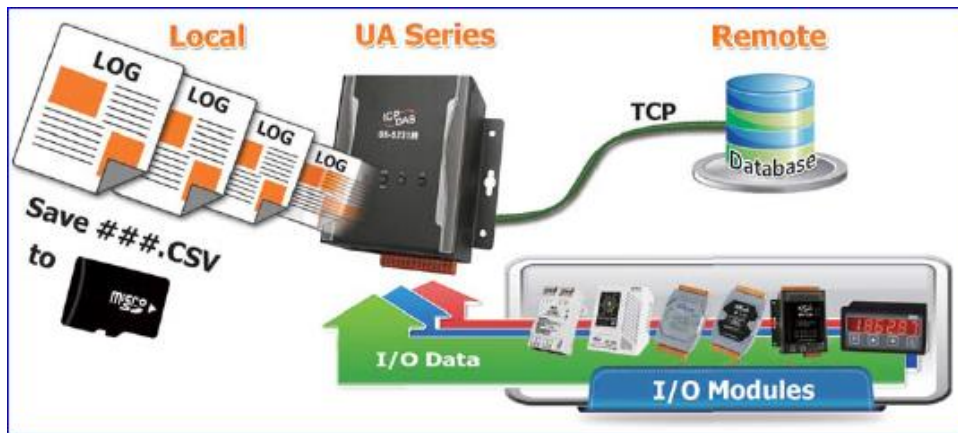

This section will introduce the setting steps and the function parameters of the “Data Log”. In the category, there are 6 items about Modbus RTU/TCP module for Local Data Logger or MS SQL, MySQL/MariaDB... Remote Database. This section will introduce the function items in 3 sub-sections.

- Data Log**
- (Master) Modbus RTU ⇒ Local Data Logger
  - (Master) Modbus TCP ⇒ Local Data Logger
  - (Master) Modbus RTU ⇒ MS SQL
  - (Master) Modbus TCP ⇒ MS SQL
  - MQTT ⇒ MS SQL
  - (Master) Modbus RTU ⇒ MySQL(MariaDB)
  - (Master) Modbus TCP ⇒ MySQL(MariaDB)
  - MQTT ⇒ MySQL(MariaDB)

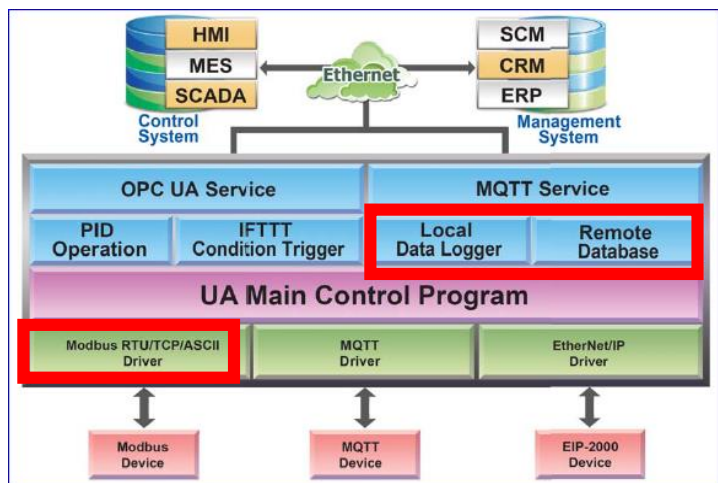

Item	Description
<b>Modbus RTU =&gt; Local Data Logger</b> <b>Modbus TCP =&gt; Local Data Logger</b>	Provide users to record I/O data of Modbus RTU/TCP module to internal register.
<b>Modbus RTU =&gt; MS SQL</b> <b>Modbus TCP =&gt; MS SQL</b> <b>MQTT =&gt; MS SQL</b>	Provide users to record I/O data of Modbus RTU/TCP module into remote database MS SQL.

Item	Description
<b>Modbus RTU =&gt; MySQL(MariaDB)</b> <b>Modbus TCP =&gt; MySQL(MariaDB)</b> <b>MQTT =&gt; MySQL(MariaDB)</b>	Provide users to record I/O data of Modbus RTU/TCP module into MySQL/MariaDB remote database.

UA FAQ Web Page: <https://www.icpdas.com/en/faq/index.php?kind=326#950>

No.	Function Wizard FAQ - Item	PDF
<b>[ Data Log ]</b>		
dbI-1	Modbus RTU / Local Data Logger	<a href="#">Use tM-AD4P2C2 and DL-302</a>
dbI-2	Modbus TCP / Local Data Logger	<a href="#">Use DL-302</a>
dbI-3	Modbus RTU / MS SQL	<a href="#">Use tM-AD4P2C2 and DL-302</a>
dbI-4	Modbus TCP / MS SQL	<a href="#">Use DL-302</a>
dbI-5	Modbus RTU / MySQL(MariaDB)	<a href="#">Use M-7026</a>
dbI-6	Modbus TCP / MySQL(MariaDB)	<a href="#">Use TPD-703 and DL-302</a>
DbI-07	MQTT / MS SQL	<a href="#">Use MQ-7255M</a>
DbI-08	MQTT / MySQL(MariaDB)	<a href="#">Use MQ-7255M</a>

## 4.4 [PID] Category

PID (Proportional-Integral-Derivative) control is the most widely used in industrial control systems. A regulator that controlled in accordance with Proportional, Integral and Derivative is called PID

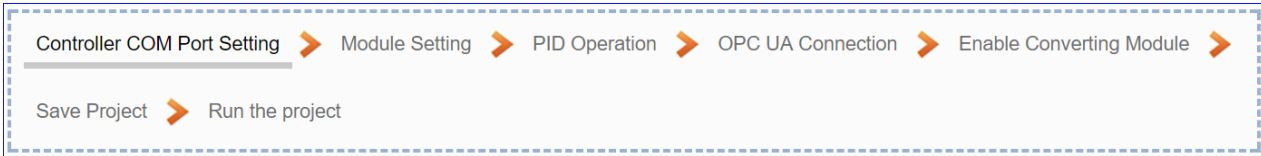

control for short, also called PID regulator. When the user cannot fully grasp or measure parameters of the control system, the PID regulator is the best solution.

The PID controller is a common feedback loop component in industrial control applications. The controller compares the collected data with a reference value and then uses this difference to calculate a new input value whose purpose is to allow the system data to reach or remain at the reference value.

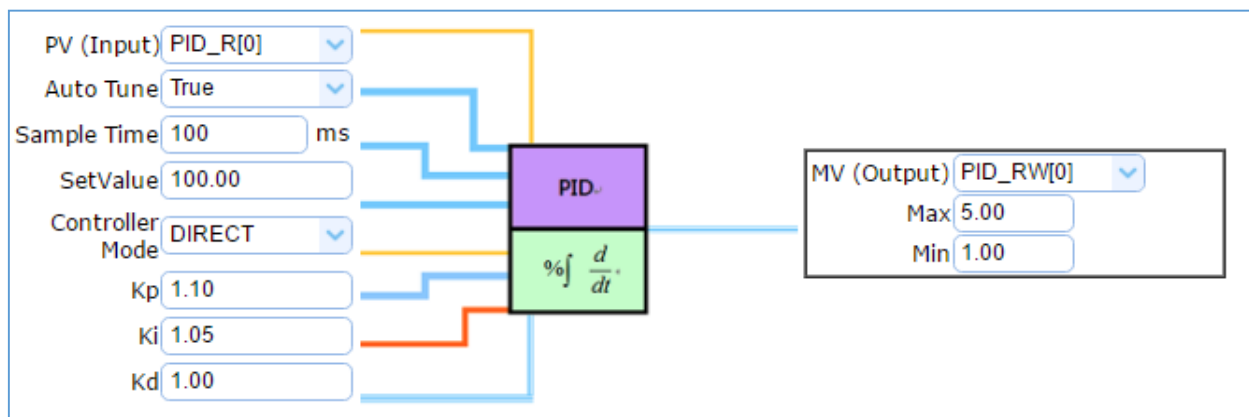

This section introduces the setting steps and the function parameters of the PID. There are 2 items about “PID” function in the “Function Wizard”. The 2<sup>nd</sup> item [PID Operation + OPC UA Communication Conversion] is combining the 1<sup>st</sup> item [PID Operation] and the FAQ. **The PID operation is for AI/AO data only, please select the AIO module when use the PID related Function Wizard.**

**PID**

- PID Operation
- PID Operation + OPC UA Communication Conversion

**[Step Box] of [PID Operation] :**

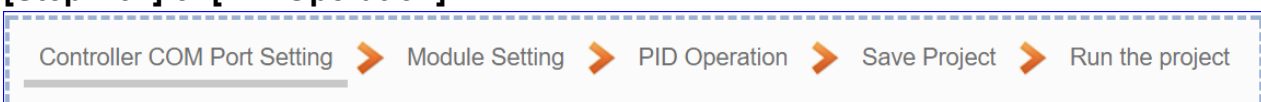

**[Step Box] of [PID Operation + OPC UA Conversion] :**

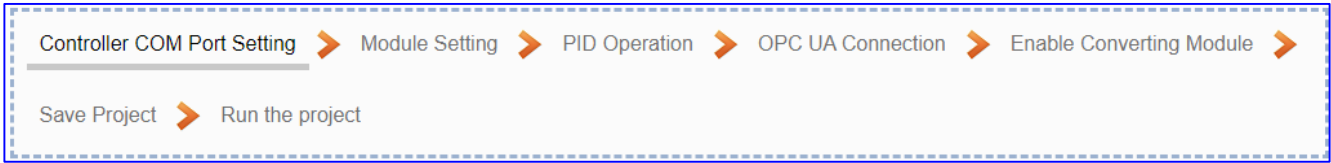

UA FAQ Web Page: <https://www.icpdas.com/en/faq/index.php?kind=326#950>

No.	Function Wizard FAQ - Item	PDF
<b>[ PID ]</b>		
pid-1	PID Operation	<a href="#">Use M-7026</a>

## 4.5 [APP Message Notify] Category

The "APP Message Notify" in the UA Function Wizard provides a condition trigger of IFTTT. IFTTT (if this then that) is a cloud service platform that easy to get your apps and devices working together via creating chains of simple conditional statements (applets). An applet is triggered by changes that occur within other web services such as Line, Twitter, Gmail, Instagram, etc. For example, "if" Line (Service A) has a new message, "then" send an email to Gmail (Service B). With the IFTTT cloud platform and UA functions, the users can send messages to IFTTT-related cloud services such as Line, Twitter, etc. when the special events occur.

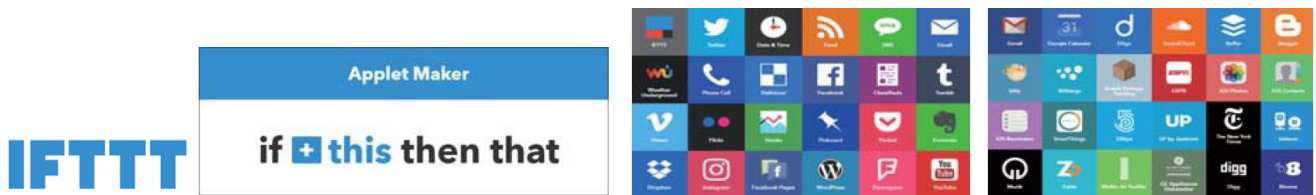

This section introduces the setting steps and the function parameters of the "APP Message Notify" and its item of "IFTTT Condition Trigger (Line, Face, Twitter)" function in the "Function Wizard".

**APP Message Notify**  
IFTTT Condition Trigger (Line · Twitter)

**[Step Box] of [ IFTTT Condition Trigger (Line, Twitter) ] :**



UA FAQ Web Page: <https://www.icpdas.com/en/faq/index.php?kind=326#950>

No.	Function Wizard FAQ - Item	PDF
<b>[ APP Message Notify ]</b>		
app-01	IFTTT Condition Trigger (Line, Twitter)	<a href="#">Use M-7055D</a>
app-02	IFTTT Condition Trigger (Line, Twitter)	<a href="#">Set up LINE Message Notify on IFTTT</a>

## 4.6 [MQTT\_Customized] Category

The " MQTT\_Customized " in the UA Function Wizard provides a custom MQTT format setting function. Users can customize the MQTT format layout and add the module value to the publishing message. With customized MQTT message content, this function can support multiple IoT platforms.

For example, to connect to the Azure platform, the user can use the standard MQTT JSON format; to connect to the AWS platform, the user can use the general standard MQTT format; to connect to the ThingSpeak platform, the user needs to customize the MQTT format according to the user needs. Then, the user can use this [MQTT customization] function to define and set up the needed MQTT format.

This section introduces the setting steps and the function parameters of the "MQTT \_Customized" and its item of "MQTT IoT Cloud" function in the "Function Wizard".



### [Step Box] of [ MQTT IoT Cloud ] :

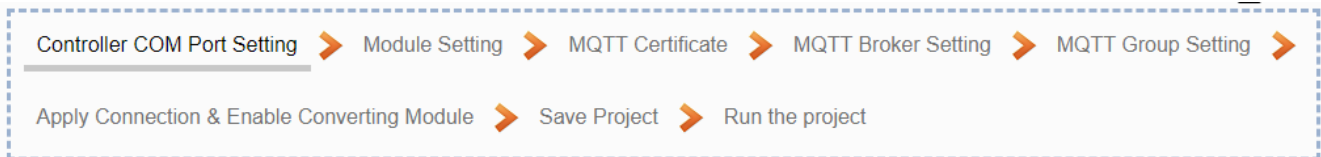

UA FAQ Web Page: <https://www.icpdas.com/en/faq/index.php?kind=326#950>

# 5 Main Menu: Parameter Settings

## 5.1 Main Menu: System Setting

**System Setting** is the first item of the Main Menu and the first screen view when login the UA Web UI. The System Setting provides the functions for system management of UA series controller and displays the version information of the system (Higher-left picture).

[System Setting] includes several sub-menu functions (Left picture) and the function descriptions are listed on the page of the Main Menu, such as the controller service, time, network, account, boot and COM port interface settings. This chapter will introduce these function items and setting parameters.

Usage : CPU 7% Memory 29.26% SD Card Log Out

System Setting Module Setting IoT Platform Setting Convert Setting Advanced Setting Logger Setting

I/O Status File Setting

System Setting

Controller Service Setting  
Time Setting  
Network Setting  
Account Setting  
Boot  
COM Port Interface Setting  
Web Secure

Firmware Version	Version 1.4.0.5
Main Program	Version 1.1.73
Web Interface	Version : 6.8.0 Date : 2022/05/18
Flash Information	eMMC Flash

Controller Service Setting	Controller Service Setting provides the function to display and set the running status of the controller service about the project, MQTT broker and DDNS.
Time Setting	Time Setting provides the function to display and set the date, time and time zone of the controller. (Include manually, synchronization, etc.)
Network Setting	Network Setting provides the function to display and set the network settings. (Include IP, host controller, DDNS, etc.)
Account Setting	Account Setting provides the function to set the username and password of the web UI.
Boot	Boot function provides the function to reboot the controller, and enable the function to run the project, MQTT broker or DDNS at startup.
COM Port Interface Setting	COM Port Interface Setting allows display and set the COM port interface of the controller for the RS-232/RS-485 serial communication.

© ICP DAS Co., Ltd. All Rights Reserved

The setting for UA series controllers is to set up from the left to the right of the main menu functions. User can find the setting step and Web UI information in the following chapters.

[CH2 Quick Start 1: Hardware/Network Connection](#)

[CH3 Quick Start 2: Web UI / Setting Steps](#)

[CH4 Function Wizard: Project Quick Setup](#)

### 5.1.1 Controller Service Setting

Controller Service Setting provides the function to display and set the running status of the controller service about the project, MQTT Broker and DDNS.

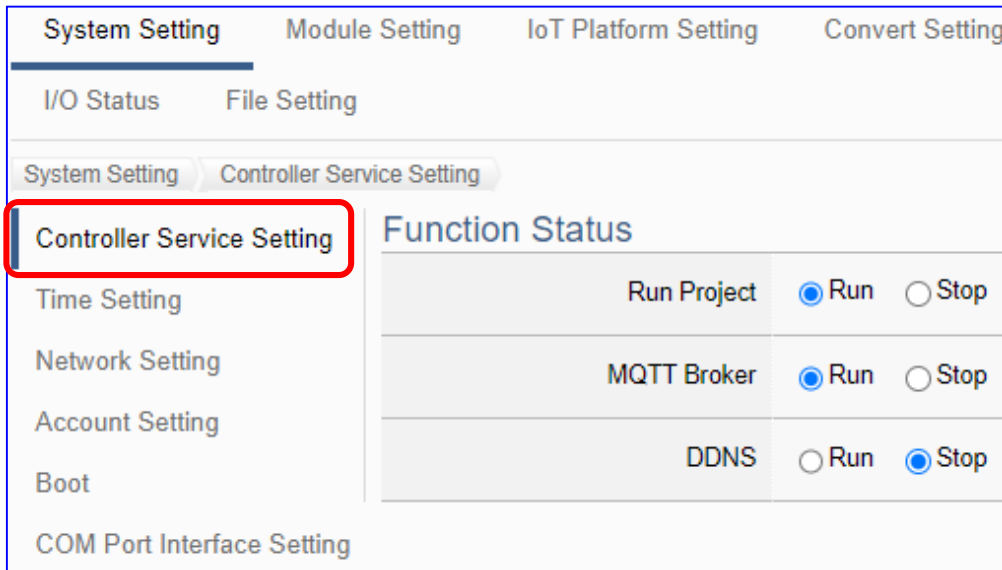

System Setting > Controller Service Setting > Functional status	
Run Project	Display the current status of project running in the UA series controller and provide “Run” and “Stop” button to switch the status. Default: Run.
MQTT Broker	Display the current status of MQTT Broker of the UA series controller and provide “Run” and “Stop” button to switch the status. Default: Run.
DDNS	Display the current status of DDNS Client of the UA series controller and provide “Run” and “Stop” button to switch the status. Default: Stop.

### 5.1.2 Time Setting

Time Setting provides the function to display and set the date, time and time zone of the controller, including manually, synchronization, etc.

Time Setting provides 3 functions: Data and Time Display, NTP Time Synchronization Setting and Set the Time Manually.

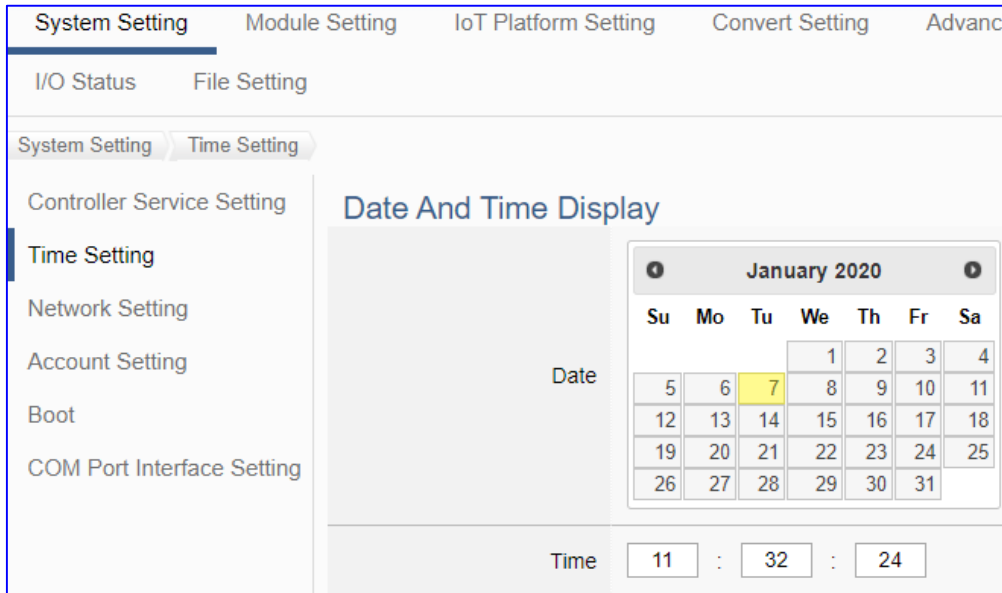

System Setting > Time Setting > Date And Time Display	
Date	Display the date of the UA series controller. The yellow block means current day. User can switch to show the date in other month.
Time	Display the current time of the UA series controller, including hour, minute and second.

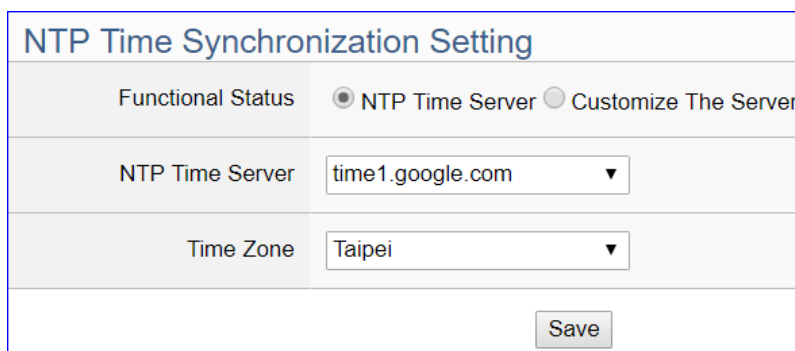

System Setting > Time Setting > NTP Time Synchronization Setting	
Functional Status / NTP Time Server	Set up one NTP Time Server from the google (4), windows and nist (4) servers for synchronization. Click “Customize The Server” and enter the IP address or the domain name can set up user own time server.
Time Zone	Set up the time zone.
Save	Click to save the settings of this item.

### Set The Time Manually

Time Setting	<input type="text" value="2017"/> / <input type="text" value="11"/> / <input type="text" value="27"/> <input type="text" value="11"/> : <input type="text" value="30"/> : <input type="text" value="16"/>
Read The Local Computer Time	<input type="button" value="Read"/>
Time Zone	<input type="text" value="Taipei"/> ▼

<b>System Setting &gt; Time Setting &gt; Set The Time Manually</b>	
Time Setting	Set the system time of the UA controller by manually. Directly enter the new year/month/date and hour:minute:second.
Read The Local Computer Time	Click [Read] can copy the current time of the using computer to the "Time Setting" of this item.
Time Zone	Set up the time zone.
Save	Click to save the settings of this item and update the data of "Time Setting" to the "Date And Time Display" on the top of this page.

### 5.1.3 Network Setting

Network Setting provides the function to display and set the network settings, including IP address, host controller, DDNS, etc.

**NOTE:**

1. UA-2800 series has 2 LANs (LAN1 / LAN2).
2. UA-2800 series supports static IP only, so it needs to specify an IP address for each LAN1 and LAN2.
3. The IPs of LAN1 and LAN2 of UA-2800 series must be set in different subnets.  
 Ex: Set one IP to 192.168.84.80, and set the other IP to other subnets, e.g. 10.1.1.2.

Network Setting (LAN1)				
Connection Mode	<input checked="" type="radio"/> Specify an IP address			
IP	<input type="text" value="192"/>	<input type="text" value="168"/>	<input type="text" value="84"/>	<input type="text" value="80"/>
Mask	<input type="text" value="255"/>	<input type="text" value="255"/>	<input type="text" value="0"/>	<input type="text" value="0"/>
Gateway	<input type="text" value="192"/>	<input type="text" value="168"/>	<input type="text" value="1"/>	<input type="text" value="1"/>
<input type="button" value="Save"/>				
Network Setting (LAN2)				
Connection Mode	<input checked="" type="radio"/> Specify an IP address			
IP	<input type="text" value="10"/>	<input type="text" value="0"/>	<input type="text" value="0"/>	<input type="text" value="1"/>
Mask	<input type="text" value="255"/>	<input type="text" value="255"/>	<input type="text" value="0"/>	<input type="text" value="0"/>
Gateway	<input type="text" value="10"/>	<input type="text" value="168"/>	<input type="text" value="1"/>	<input type="text" value="1"/>
<input type="button" value="Save"/>				

<b>System Setting &gt; Network Setting &gt; Network Setting (LAN1)</b>	
Connection Mode	<b>Specify an IP address:</b> Users input the values in the fields of IP, Mask and Gateway according to customer's network. Detail information for the factory default value of UA controller network refers to the <a href="#">Section 2.2.1</a> .
IP	The LAN1 IP address of this UA. Factory Default: 192.168.255.1
Mask	The LAN1 mask address of this UA. Factory Default: 255.255.0.0
Gateway	The LAN1 gateway address of this UA. Factory Default: 192.168.1.1
Save	Click to save the settings of LAN1 item.
<b>System Setting &gt; Network Setting &gt; Network Setting (LAN2)</b>	
Connection Mode	<b>Specify an IP address:</b> Users input the values in the fields of IP, Mask and Gateway according to customer's network. Detail information for the factory default value of UA controller network refers to the <a href="#">Section 2.2.1</a> .
IP	The LAN2 IP address of this UA. Factory Default: 10.0.0.1
Mask	The LAN2 mask address of this UA. Factory Default: 255.255.0.0
Gateway	The LAN2 gateway address of this UA. Factory Default: 10.168.1.1
Save	Click to save the settings of LAN2 item.

IPv6

LAN1	
Connection Mode	<input checked="" type="radio"/> Specify an IP address
IP	<input type="text" value="fe80::d8da:247d:4d15:9bb9"/>
Prefix length	<input type="text" value="64"/>
Gateway	<input type="text" value="2001:b400::f153:1dc6:10d5"/>
<input type="button" value="Save"/>	

<b>System Setting &gt; Network Setting &gt; IPv6</b>	
LAN1	IPV6 address of this controller LAN1 or LAN2.
Connection Mode	Set the IPV6 address and specify the IP, prefix length, and gateway fields below to manually input. or automatically generated by DHCP
IP	IPV6 address of this controller LAN1 or LAN2
Prefix length	IPV6 subnet prefix length of the controller LAN1 or LAN2
Gateway	IPV6 gateway address of the controller LAN1 or LAN2
Save	Click to save the settings of this item.

### Hostname Setting

Hostname	<input type="text" value="UA-5231-68C90BE4E5A5"/>
----------	---

<b>System Setting &gt; Network Setting &gt; Hostname Setting</b>	
Hostname	The host name of this UA. Default: system value. User can give a new name, but cannot be null.
Save	Click to save the settings of this item.

### Dynamic DNS Setting

Service Provider	<input style="border: none; border-bottom: 1px solid #ccc;" type="text" value="NO-IP"/> ▼
*Username	<input type="text" value="undefined"/>
*Password	<input type="password" value="....."/>
*Domain Name	<input type="text" value="undefined"/>

<b>System Setting &gt; Network Setting &gt; Dynamic DNS Setting</b>	
Service Provider	Select the company of the DDNS service. Default: NO-IP. Supports: NO-IP, ChangelP.com, DynDNS, FreeDNS.
*Username	Set up the login user name. The star * means the field cannot be null. Default: undefined.
*Password	Set up the login password. The star * means the field cannot be null.
*Domain Name	Define the parked domain name of the DDNS. The star * means the field cannot be null. Default: undefined.
Save	Click to save the settings of this item.

\* The star “ \* ” means the field cannot be null.

### 5.1.4 Account Setting

Account Setting provides the function to set the login username and password of the UA web UI.

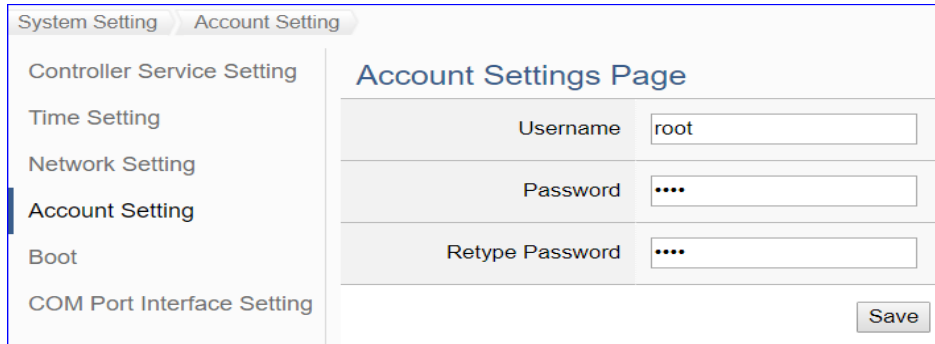

System Setting > Account Setting > Account Settings Page	
Username	The login username for the UA Web UI. Factory default: root
Password	The login password for the UA Web UI. Factory default: root
Retype Password	Retype the password for the operation conform when setting the new account information.
Save	Click to save the settings of this page.

**After first login, change your password as soon as possible for your system safety.**

#### Steps to change the username and password:

1. Type the new username in the “Username” item.
2. Type the new password in the “Password” item.
3. Retype the new password in the “Retype Password” item.
4. Click the “Save”. Then re-login the UA Web UI with the new username and password.

Factory Default Settings of UA Series			
Network	IP (LAN1)	192.168.255.1	Assign UA a new IP address according to your case. Set the <b>LAN1</b> for the PC connection.
	IP (LAN2)	10.0.0.1	
	Mask	255.255.0.0	
	Gateway	LAN1: 192.168.1.1 LAN2: 10.168.1.1	
Web UI Account	Username	root	<b>After login, change your password as soon as possible.</b> (Section 5.1.4 for Web UI)
	Password	root	

### 5.1.5 Boot

Boot function provides the function to reboot the UA series controller, and enable the function to run the project, MQTT broker or DDNS at startup.

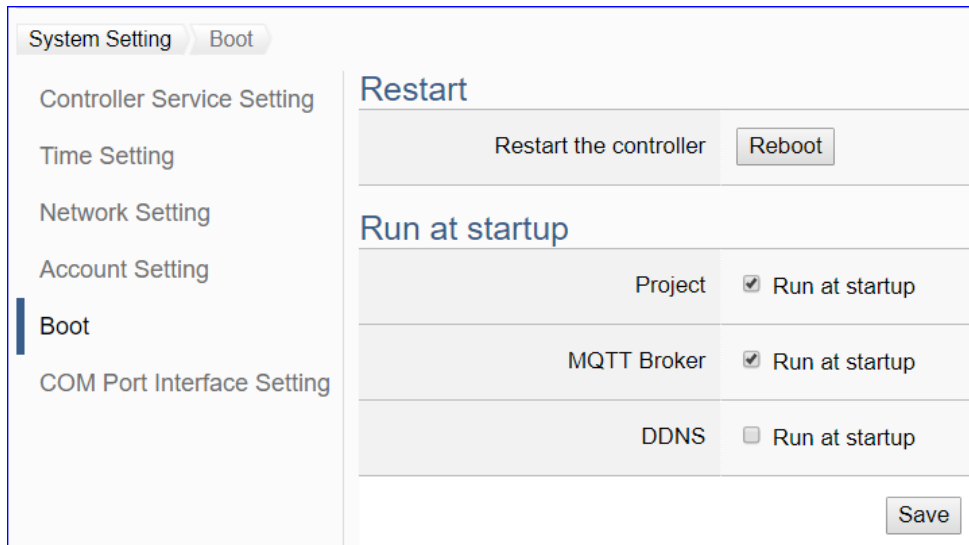

<b>System Setting &gt; Boot &gt; Restart</b>	
Restart the controller	Click "Reboot" can restart the UA controller at once.
<b>System Setting &gt; Boot &gt; Run at startup</b>	
Project	Check the "Run at startup" box can set the project to run at the UA controller startup. Default: check.
MQTT Broker	Check the "Run at startup" box can set the MQTT Broker to run at the UA controller startup. Default: check.
DDNS	Check the "Run at startup" box can set the DDNS to run at the UA controller startup. Default: uncheck.
Save	Click to save the settings of this page.

### 5.1.6 COM Port Interface Setting

COM Port Interface Setting allows display and set the COM port interface of the UA series controller for the RS-232/RS-485 serial communication.

System Setting > COM Port Interface Setting > COM Port Interface Setting Page	
Serial Port	Choose the serial port of UA controller that links with the I/O module. UA-2800: COM2 (RS-232); COM3 (RS-485); COM4 (RS-485) Select the port that the module is actually connected to.
Baud Rate	Choose a baud rate to communicate with the module: 1200, 2400, 4800, 9600, 19200, 38400, 57600 and 115200. The UA controller and the I/O module need have the same baud rate. Default: 115200.
Data Bits	The number of bits used to represent one byte of data: 7 bits or 8 bits. Default: 8 Bits.
Parity	Choose one way for the parity checking. Options: None, Even, and Odd. Default: None.
Stop Bits	Choose the number of stop bit: 1 bit or 2 bits. Default: 1.
Polling Rate (ms)	Set a time interval for the command. Minimum: 20 ms. Default: 500 ms
Save	Click to save the settings of this page.

### 5.1.7 Web Secure

This function is mainly to set the security options and related parameter descriptions of the web page.

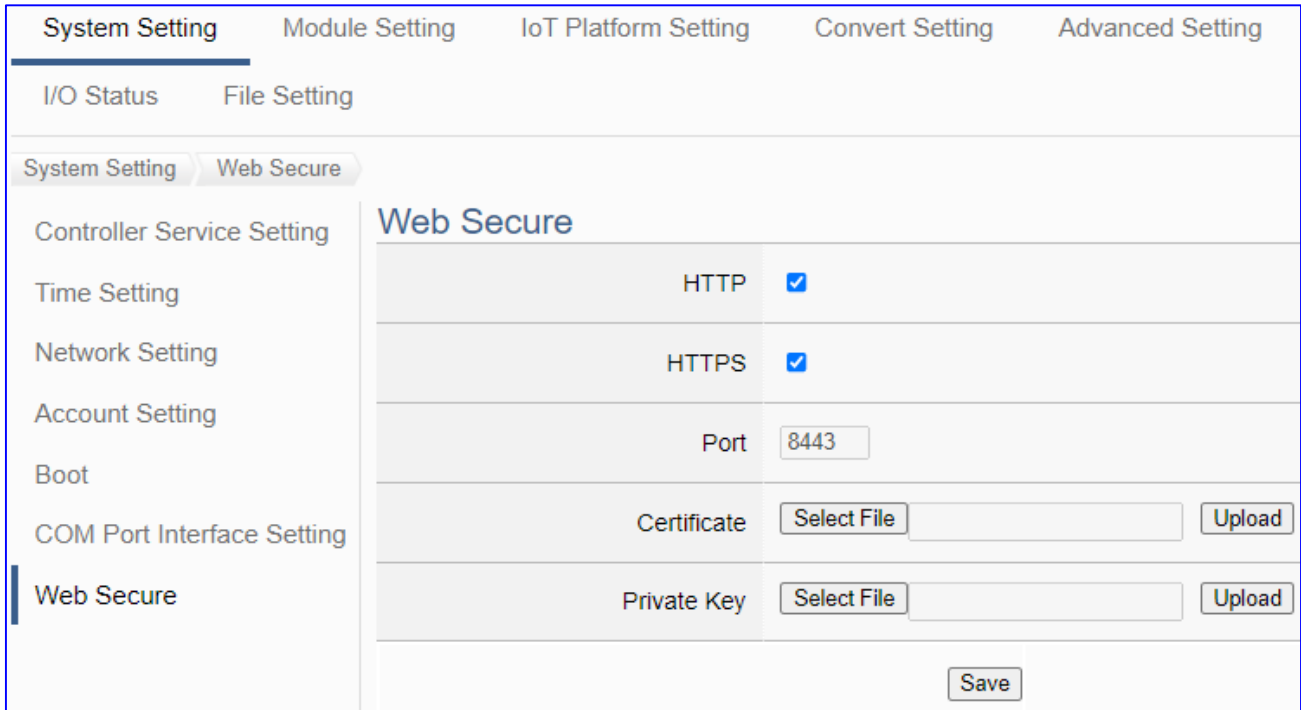

System Setting > Web Secure –Web Secure	
HTTP	Check box to enable web HTTP communication (Default: Enable)
HTTPS	Check box to enable web HTTPS communication Port Number: 8443
Certificate	Certificate required for HTTPS communication. The user can select the certificate file on the browser side by clicking the “Select File” button. Then upload by clicking the “Upload” button.
Private Key	Private key required for HTTPS communication. The user can select the Private Key file on the browser side by clicking the “Select File” button. Then upload by clicking the “Upload” button.

After uploading the certificate and private key, when using HTTPS to securely encrypt the webpage, please enter “**https://**” in the address bar of the browser, add the **IP**, add the UA HTTPS port number “**:8443**” **after the IP**, and then press Enter to enter the webpage, the example is as follows:



## 5.2 Main Menu: Module Setting

**Module Setting** is the second item of the Main Menu. The Module Setting provides the functions for UA series controller to connect the remote Modbus (RTU/TCP/ASCII module), remote MQTT and remote EtherNet/IP module.

[Module Setting] includes three sub-menu functions (see the picture below) and the function descriptions are listed on the page of the Main Menu, such as the Modbus RTU Module (Master), TCP Module (Master), ASCII Module (Master), MQTT and ICP DAS EIP Module. The Module Setting will support more modules in the future. This chapter will introduce the current function items and setting parameters.

Module Setting	
<b>Modbus</b>	
RTU Module (Master)	This setting is for connecting the remote Modbus RTU Slave module.
TCP Module (Master)	This setting is for connecting the remote Modbus TCP Slave module.
ASCII Module (Master)	This setting is for connecting the remote Modbus ASCII Slave module.
<b>MQTT</b>	
MQTT Module	This setting is for connecting the remote MQTT module.
<b>EtherNet/IP</b>	
ICPDAS Module	This setting is for connecting the remote ICPDAS EIP module.
<b>XV Board</b>	
XV Module	This setting is used to set the XV module on the expansion board.
<b>Internal</b>	
Internal Module	The internal module can create virtual internal variables for reading and writing or as an intermediary to provide data exchange of communication protocols.

The setting for UA series controllers is to set up from the left to the right of the main menu functions. User can find the setting step and Web UI information in the following chapters.

[CH2 Quick Start 1: Hardware/Network Connection](#)

[CH3 Quick Start 2: Web UI / Setting Steps](#)

[CH4 Function Wizard: Project Quick Setup](#)

Recommend to use ICP DAS module, system will auto set up the Modbus Mapping Table. The user can check the module Modbus address or I/O number from the user manual.

Website: <https://www.icpdas.com/en/product/p02.php?root=537>

### 5.2.1 Modbus RTU (Master)

This setting is for UA Controller connecting the remote Modbus RTU Slave module.

This page is for setting the communication values with the connected modules. First choose the serial port that connected with the module, and each module can give a name (Default: Name). Click [ + ] button could add a new module. If using ICP DAS module, user just need to select the model number, system will auto add and setup the module. Click [Edit] button can configure the module content and the Modbus mapping table.

#### Setting Steps:

1. Select the module Serial port
2. Click the switch icon  to select the adding mode:
  - a) **Select The Module:** Select an ICP DAS model (as the pic), system will auto setup.
  - b) **Name:** Give a name, e.g. M-7055D. Click [ + ] to add a module for user setting.
3. Click the button [Edit] to enter the Module Content Setting page  
View or set the Modbus Mapping Table for the UA series and module I/O channels

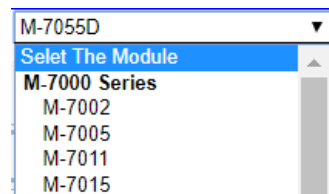



Click [Edit] button to enter the “Module Content Setting” page.  
 Enter the **Module Content Setting** page.

**Module Content Setting**

No.

Module Name

Slave ID

Timeout(ms)

Write Retry

---

**Modbus Mapping Table Setting**

Data Model  ▼

Start Address

Data Number

Create Tables

If select ICP DAS module, system will auto set up the Modbus Mapping Table, or user needs to check the module Modbus address or I/O number from the module user manual.

> **Modbus Mapping Table Setting:**  
 Set module in the order of Data Model, Start Address and Data Number, then click “Add”.

**Ex:** M-7055D has 8 Data Models of “01 Coil Status (0x)” (Mapping: DO), so select Model “01”, Start Add. “0”, Number “8”, and click “Add”.

Coil Status(0x)

Address	0
Number	8
Type	Bool

Module Content Setting			
No.	The module number in the module list (Not editable here)		
Module Name	Give a name, e.g. model number or name. Default: Name.		
Slave ID	Set the module Slave ID of the UA. (Range: 1 ~ 247)		
Timeout	Set the timeout value for the module. Default: 500 ms		
Write Retry	Check to retry writing again when there is no response after the set time is up, and it can be set up to retry 3 times		
Modbus Mapping Table Setting			
Data Model	System provides 4 Modbus data models for mapping to the Modbus address of the Ch.: Coil Status, Input Status, Holding Registers, Input Registers.	Data Model	Modbus Addr.Ch. Type
		Coil Status	0xxxxx DO
		Input Status	1xxxxx DI
		Holding Registers	2xxxxx AO
Input Registers	3xxxxx AI		
Data Model	System provides 4 Modbus data models for mapping to the Modbus address of the channels.		
Start Address	The start address of the Modbus command. <b>Note:</b> the Start Address of UA is base 0, even if some modules are base 1, here it needs to follow UA to set base 0.		
Data Number	Set the number of module channel (DO, DI, AO, AI) data according to "Data Model". Default: 1.		
Type	This item only appears when the data model is 03 or 04. Set it according to the module data: 16-bit Short, 16-bit Unsigned Short, 32-bit Long, 32-bit Unsigned Long, 64-bit Int64, 32-bit Float, 64-bit Double. <b>Note:</b> 32-bit and 64-bit data occupy 2 and 4 Modbus Register addresses.		
Create Tables	Click [Add] button, it will add a table in the Modbus mapping table.		



### Nickname Setting:

Setting the variable nickname and description.

Modbus Mapping Table
Address Setting
Nickname Setting

01 Coil Status(0x)

Table Display
Show Hide

Address	Variable name	Data Type	Description
0	<input type="text" value="Tag0"/>	Bool	<input style="width: 100%;" type="text"/>
1	<input type="text" value="Tag1"/>	Bool	<input style="width: 100%;" type="text"/>

02 Input Status(1x)

Table Display
Show Hide

Address	Variable name	Data Type	Description
0	<input type="text" value="Tag0"/>	Bool	<input style="width: 100%;" type="text"/>

03 Holding Registers(4x)

Table Display
Show Hide

Address	Variable name	Data Type	Swap	Description
0	<input type="text" value="Tag0"/>	Short	<input type="checkbox"/>	<input style="width: 100%;" type="text"/>

04 Input Registers(3x)

Table Display
Show Hide

Address	Variable name	Data Type	Swap	Description
0	<input type="text" value="Tag0"/>	Float	<input type="checkbox"/>	<input style="width: 100%;" type="text"/>

OK Cancel

Modbus Mapping Table – Nickname Setting	
Modbus Mapping Table	Coil Status(0x): Mapping to DO Modbus address Input Status(1x): Mapping to DI Modbus address Holding Registers(4x): Mapping to AO Modbus address Input Registers(3x): Mapping to AI Modbus address
Table Display	Click [Show] to display all fields, click [Hide] to hide some fields.
Address	Modbus address. System auto arrange.
Variable name	The variable name of the mapping address. Default: Tag0 and auto arrange the number. User can define the name.
Data Type	Display data type of the variable. (Not editable)
Swap	Check to swap the byte order (Lo-Hi/Hi-Lo) for 4-byte or 8-byte.
Description	Write a note for this variable.
OK	Click to save this page settings and back to the module list page.

● **\*\* Scaling**

**Scaling is only available in the AI/AO settings of Modbus RTU/TCP.** When the variable value needs to be scaled or converted before output, click the **"Advanced Setting"** button of the variable on the **Scaling** page, input the **Min./Max./Offset** of the Reference/Output items, add a description, and check **"Enable"** box, The Scaling conversion function will be activated.

Modbus Mapping Table – Scaling	
Modbus Mapping Table	Holding Registers(4x): Mapping to AO Modbus address Input Registers(3x): Mapping to AI Modbus address <b>Scaling do not support 01 Coil Status(0x):DO &amp; 02 Input Status(1x):DI</b>
Table Display	Click [Show] to display all fields, click [Hide] to hide some fields.
Address	Modbus address. System auto arrange.
Reference	The I/O variable of the Modbus address.
Output	The scaling variable for scaling output. User can define the variable name.
Scaling	Click [Show Detail] to set up the Scaling parameters, and click [Hide Detail] to hide the parameters. Fill in the Min/Max range values of the source in the Reference column. Fill in the Min/Max range values after scaling in the Output column. If needs offset, fill the offset value in the Offset item. Remember check “Enable” box.
Enable	Check the box of the variable can enable just that variable for scaling.
Description	Write a note for this variable.
OK	Click to save this page settings and back to the module list page.

● **\*\* Bitwise**

**Bitwise is only available in the AI/AO settings of Modbus RTU/TCP.** When the data needed to take out the value of the specified bit, fill in the variable name in the specified Bit# of the required address, and the value of the bit can be output to the filled variable.

Modbus Mapping Table
Address
Nickname
Scaling
Bitwise

**03 Holding Registers(4x)**

Table Display Show Hide

Address	Reference	Bitwise
14	<div style="border: 1px solid gray; padding: 2px; margin-bottom: 5px;">Tag14</div> <div style="display: flex; flex-direction: column; gap: 2px;"> <div style="display: flex; align-items: center;"><span style="border: 1px solid green; border-radius: 5px; padding: 2px;">Bit0</span> HR14_Bit0</div> <div style="display: flex; align-items: center;"><span style="border: 1px solid green; border-radius: 5px; padding: 2px;">Bit2</span> HR14_Bit2</div> <div style="display: flex; align-items: center;"><span style="border: 1px solid green; border-radius: 5px; padding: 2px;">Bit4</span> HR14_Bit4</div> <div style="display: flex; align-items: center;"><span style="border: 1px solid green; border-radius: 5px; padding: 2px;">Bit6</span> HR14_Bit6</div> <div style="display: flex; align-items: center;"><span style="border: 1px solid green; border-radius: 5px; padding: 2px;">Bit8</span> HR14_Bit8</div> <div style="display: flex; align-items: center;"><span style="border: 1px solid green; border-radius: 5px; padding: 2px;">Bit10</span> HR14_Bit10</div> <div style="display: flex; align-items: center;"><span style="border: 1px solid green; border-radius: 5px; padding: 2px;">Bit12</span> HR14_Bit12</div> <div style="display: flex; align-items: center;"><span style="border: 1px solid green; border-radius: 5px; padding: 2px;">Bit14</span> HR14_Bit14</div> </div>	<div style="border: 1px solid gray; padding: 2px; margin-bottom: 5px; text-align: right;">Hide</div> <div style="display: flex; flex-direction: column; gap: 2px;"> <div style="display: flex; align-items: center;"><span style="border: 1px solid green; border-radius: 5px; padding: 2px;">Bit1</span> HR14_Bit1</div> <div style="display: flex; align-items: center;"><span style="border: 1px solid green; border-radius: 5px; padding: 2px;">Bit3</span> HR14_Bit3</div> <div style="display: flex; align-items: center;"><span style="border: 1px solid green; border-radius: 5px; padding: 2px;">Bit5</span> HR14_Bit5</div> <div style="display: flex; align-items: center;"><span style="border: 1px solid green; border-radius: 5px; padding: 2px;">Bit7</span> HR14_Bit7</div> <div style="display: flex; align-items: center;"><span style="border: 1px solid green; border-radius: 5px; padding: 2px;">Bit9</span> HR14_Bit9</div> <div style="display: flex; align-items: center;"><span style="border: 1px solid green; border-radius: 5px; padding: 2px;">Bit11</span> HR14_Bit11</div> <div style="display: flex; align-items: center;"><span style="border: 1px solid green; border-radius: 5px; padding: 2px;">Bit13</span> HR14_Bit13</div> <div style="display: flex; align-items: center;"><span style="border: 1px solid green; border-radius: 5px; padding: 2px;">Bit15</span> HR14_Bit15</div> </div>
15	<div style="border: 1px solid gray; padding: 2px; margin-bottom: 5px;">Tag15</div>	<div style="border: 1px solid gray; padding: 2px; margin-bottom: 5px;">Advanced settings</div>

**04 Input Registers(3x)**

Table Display Show Hide

Address	Reference	Bitwise
---------	-----------	---------

OK Cancel

<b>Modbus Mapping Table – Bitwise</b>	
Modbus Mapping Table	Holding Registers(4x): Mapping to AO Modbus address Input Registers(3x): Mapping to AI Modbus address <b>Bitwise do not support 01 Coil Status(0x):DO &amp; 02 Input Status(1x):DI</b> <b>Bitwise do not supports 32-bit Float &amp; 64-bit Double data types.</b>
Table Display	Click [Show] to display all fields, click [Hide] to hide some fields.
Address	Modbus address. System auto arrange.
Reference	The Bit# variables of the Modbus address.
Bitwise	Set up the variables for Bitwise. Click [Advanced Settings] to set up the Bitwise parameters, and click [Hide] to hide the parameters. Fill in the variable names to the Bit# that wanted to do the Bitwise. The value in the fixed bit number will be assigned into the variable.
OK	Click to save this page settings and back to the module list page.

### 5.2.2 Modbus TCP (Master)

This setting is for UA Controller connecting the remote Modbus TCP Slave module.

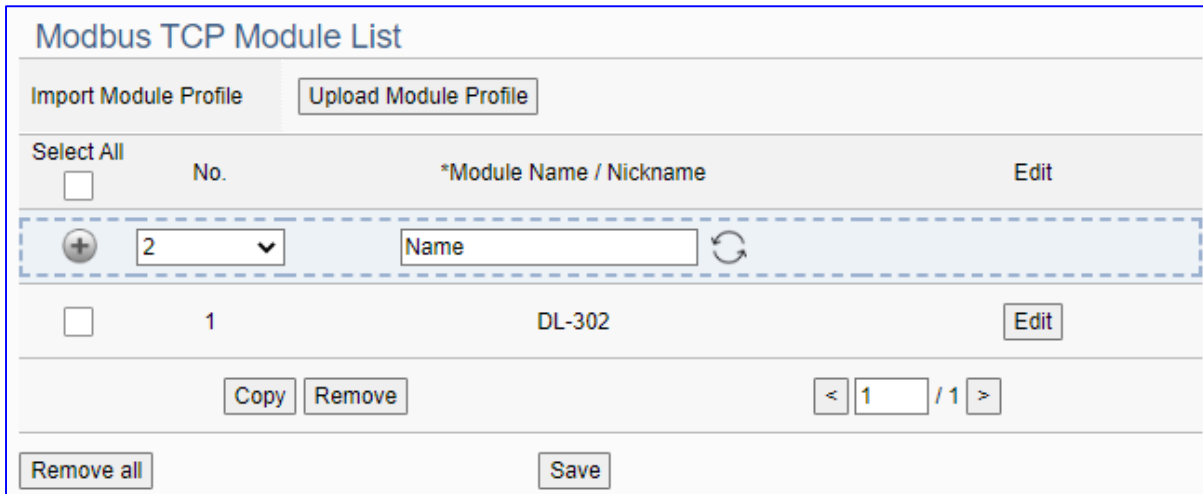

This section shows the settings for the Modbus TCP module on Ethernet LAN. User can give module a name (Default: Name), click [ + ] button to add a new module, and then setup the module. If using ICP DAS module, user can just select the model, system will auto add and setup the module. Click [Edit] button to set the module content and the Modbus mapping table.

#### Setting Steps:

1. Click the switch icon  to select the adding mode:

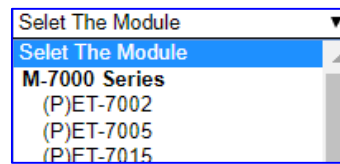

a) **Select The Module:** Select an ICP DAS model (as the pic), system will auto setup.

b) **Name:** Give a name, e.g. DL-302. Click [ + ] to add a module for user setting.

2. Click the button [Edit] to enter the Module Content Setting page

View or set the Modbus Mapping Table for the UA Series and module I/O channels

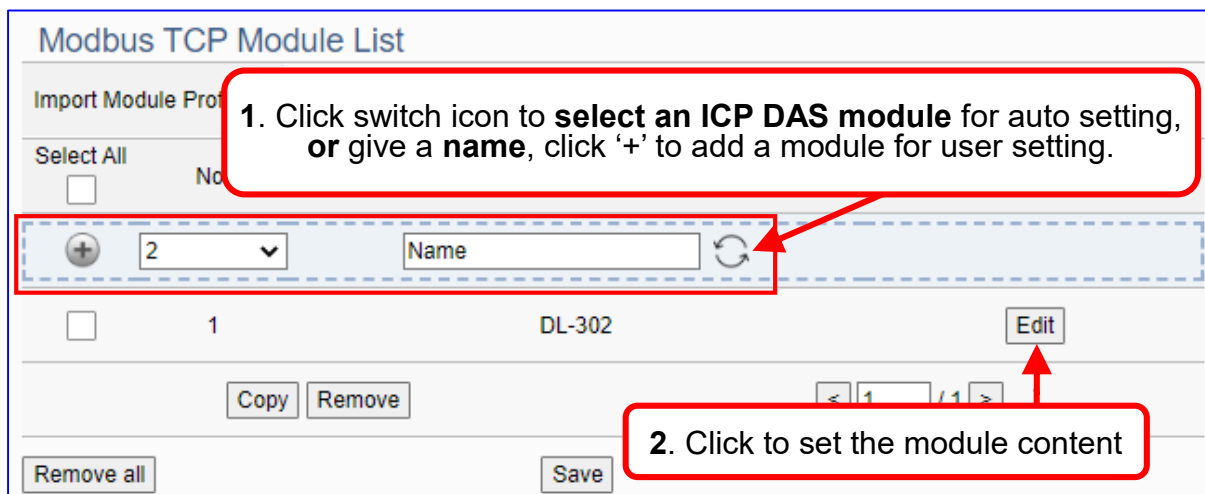

The function items and setting parameters of the [Modbus TCP Module List]:

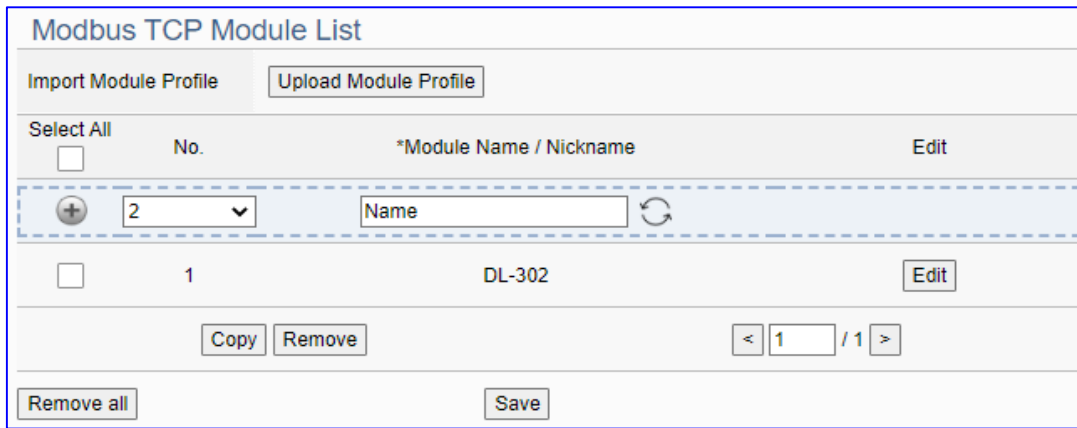

Module Setting > Modbus - RTU Module (Master) > Modbus RTU Module List		
Import Module Profile: Upload Module Profile	1. Click to import the pre-edited <b>.csv</b> module profile (see UA-FAQ) 2. Click to import the <b>.json</b> ICP DAS module list. Go to UA <a href="#">Download Center &gt; Firmware</a> to download the new .json Module List.	
Select All <input type="checkbox"/>	Check the box "Select All" will select all modules in the list. Check the box in the left of the module is to select that module list, can delete or copy the module.	
	Click to add a list of module.	
No.	The module number in the module list (System arrange, not editable)	
*Module Name / Nickname	Module name (*: cannot be null). Click  can switch setting mode. <b>Name:</b> User give a name to set up the module. <b>Select The Module:</b> Select a ICP DAS model, system auto-setup the module.	
Edit	Click to set the module in the Module Content Setting page.	
Copy	Select the module wants to copy by check the box and click [Copy] can copy module by assigning port and quantity. Yes: copy the module and exit. No: exit without copy.	
Remove	Click to delete the checked module(s)	
Remove all	Click to delete all modules linked with the selected port. Remove: delete the modules and exit. No: exit without delete module.	
	The page number / total pages of the module list. Click < or > to go to the previous or the next page.	
Save	Click to save the settings of this page.	

Click [Edit] can enter the [Module Content Setting] page to set up the module and the Modbus address mapping table.

Module Content Setting	
No.	1
Module Name	Name
IP	0 . 0 . 0 . 0
Port	502
Slave ID	1
Timeout	500
Polling Rate	500
Modbus Mapping Table Setting	
Data Model	01 Coil Status(0x)
Start Address	0
Data Number	1
Create Tables	Add

If select ICP DAS module, system will auto set up the Modbus Mapping Table, or user needs to check the module Modbus address or I/O number from the module user manual.

> **Modbus Mapping Table Setting:**

Set module in the order of Data Model, Start Address and Data Number, then click "Add".

**Ex:** DL-302 has 6 Data Models of "04 Input Registers (3x)" (Mapping: AI), so select Model "04", start 0, number 6, type Short, and click "Add".

Input Registers(3x)	
Address	0
Number	6
Type	Short
Edit	

Module Content Setting				
No.	The module number in the module list (Not editable here)			
Module Name	Give a name, e.g. model number or name. Default: Name.			
IP	The IP address of the connected module. Default: 0.0.0.0			
Port	The port number for Modbus TCP. Default: 502			
Slave ID	Set the Slave ID of the UA. (Range: 1 ~ 247)			
Timeout	Set the timeout value for the module. Default: 500 ms			
Polling Rate	Set a time interval for the command. Default: 500 ms			
Modbus Mapping Table Setting				
Data Model	System provides 4 Modbus data models for mapping to the Modbus address of the Ch.: Coil Status, Input Status, Holding Registers, Input Registers.	Data Model	Modbus Addr.	Ch. Type
		Coil Status	0xxxxx	DO
		Input Status	1xxxxx	DI
		Holding Registers	2xxxxx	AO
		Input Registers	3xxxxx	AI
Start Address	The start address of the Modbus command. <b>Note:</b> the Start Address of UA is base 0, even if some modules are base 1, here it needs to follow UA to set base 0.			
Data Number	Set the number of module channel (DO, DI, AO, AI) data according to "Data Model". Default: 1.			
Type	This item only appears when the data model is 03 or 04. Set it according to the module data: 16-bit Short, 16-bit Unsigned Short, 32-bit Long, 32-bit Unsigned Long, 64-bit Int64, 32-bit Float, 64-bit Double. <b>Note:</b> 32-bit and 64-bit data occupy 2 and 4 Modbus Register addresses.			
Create Tables	Click [Add] button, it will add a table in the Modbus mapping table.			

The finished Modbus Mapping Table as below is in order of DO, DI, AO and AI.

**Address Setting:**

Display and edit the Modbus Mapping Table.

Modbus Mapping Table		Address	Nickname	Scaling	Bitwise
Coil Status(0x)	Input Status(1x)	Holding Registers(4x)		Input Registers(3x)	
				Address	0
				Number	6
				Type	Short
				<input type="button" value="Edit"/>	
		<input type="button" value="OK"/>		<input type="button" value="Cancel"/>	

If user selects ICP DAS module, the system will auto set up the Modbus Mapping Table. If not, user needs to check the module Modbus address or I/O number from the module user manual.

Modbus Mapping Table – Address Setting	
Address Setting	The “Address Setting” page of the Modbus Mapping Table
Nickname Setting	Click can switch to the The “Nickname Setting” page of the Modbus Mapping Table. (Next page)
Modbus Mapping Table	Coil Status(0x): Mapping to DO Modbus address Input Status(1x): Mapping to DI Modbus address Holding Registers(4x): Mapping to AO Modbus address Input Registers(3x): Mapping to AI Modbus address
Address	The start address of the Modbus command. Default: 0. <b>Note:</b> the Start Address of UA is base 0, even if some modules are base 1, here it needs to follow UA to set base 0.
Number	The number of the Modbus address. Need to give enough number for the DO, DI, AO, AI channels of the module. At least 1.
Type	DO/DI type: Bool (Boolean) AO/AI type: depend on setting of [Modbus Mapping Table Setting]
Edit	Click to change the address and Number.
Delete	Click to delete this address table.
Save	Click to save and exit this table editing.
Cancel	Click to exit without saving and back to the module list page.
OK	Click to save this page settings and back to the module list page.

**Nickname Setting:**

Setting the variable nickname and description.

Modbus Mapping Table					Address	Nickname	Scaling	Bitwise
<b>01 Coil Status(0x)</b>								
Table Display					<input type="button" value="Show"/> <input type="button" value="Hide"/>			
Address	Variable name	Data Type	Description					
<b>02 Input Status(1x)</b>								
Table Display					<input type="button" value="Show"/> <input type="button" value="Hide"/>			
Address	Variable name	Data Type	Description					
<b>03 Holding Registers(4x)</b>								
Table Display					<input type="button" value="Show"/> <input type="button" value="Hide"/>			
Address	Variable name	Data Type	Swap	Description				
<b>04 Input Registers(3x)</b>								
Table Display					<input type="button" value="Show"/> <input type="button" value="Hide"/>			
Address	Variable name	Data Type	Swap	Description				
0	<input type="text" value="CO2"/>	Short	<input type="checkbox"/>	<input type="text" value="room1"/>				
1	<input type="text" value="Relative_humidity"/>	Short	<input type="checkbox"/>	<input type="text"/>				
2	<input type="text" value="Temperature_Celsius"/>	Short	<input type="checkbox"/>	<input type="text"/>				

Modbus Mapping Table – Nickname Setting	
Modbus Mapping Table	Coil Status(0x): Mapping to DO Modbus address Input Status(1x): Mapping to DI Modbus address Holding Registers(4x): Mapping to AO Modbus address Input Registers(3x): Mapping to AI Modbus address
Table Display	Click [Show] to display all fields, click [Hide] to hide some fields.
Address	Modbus address. System auto arrange.
Variable name	The variable name of the mapping address. Default: Tag0 and auto arrange the number. User can define the name.
Data Type	Display data type of the variable. (Not editable)
Swap	Check to swap the byte order (Lo-Hi/Hi-Lo) for 4-byte or 8-byte.
Description	Write a note for this variable.
OK	Click to save this page settings and back to the module list page.

● **\*\* Scaling**

**Scaling is only available in the AI/AO settings of Modbus RTU/TCP.** When the variable value needs to be scaled or converted before output, click the "**Advanced Setting**" button of the variable on the **Scaling** page, input the **Min./Max./Offset** of the Reference/Output items, add a description, and check "**Enable**" box, The Scaling conversion function will be activated.

Modbus Mapping Table – Scaling	
Modbus Mapping Table	Holding Registers(4x): Mapping to AO Modbus address Input Registers(3x): Mapping to AI Modbus address <b>Scaling do not support 01 Coil Status(0x):DO &amp; 02 Input Status(1x):DI</b>
Table Display	Click [Show] to display all fields, click [Hide] to hide some fields.
Address	Modbus address. System auto arrange.
Reference	The I/O variable of the Modbus address.
Output	The scaling variable for scaling output. User can define the variable name.
Scaling	Click [Show Detail] to set up the Scaling parameters, and click [Hide Detail] to hide the parameters. Fill in the Min/Max range values of the source in the Reference column. Fill in the Min/Max range values after scaling in the Output column. If needs offset, fill the offset value in the Offset item. Remember check “Enable” box.
Enable	Check the box of the variable can enable just that variable for scaling.
Description	Write a note for this variable.
OK	Click to save this page settings and back to the module list page.



### 5.2.3 Modbus ASCII (Master)

This setting is for UA Controller connecting the remote Modbus ASCII Slave module.

This page is for setting the communication values with the connected modules. First choose the serial port that connected with the module, and each module can give a name (Default name: Name). Click [ + ] button could add a new module, and then click [Edit] button to configure the module content and the Modbus mapping table.

#### Setting Steps:

1. Select the module connecting Serial port
2. Give the module name or nickname, e.g. module number. Default: Name
3. Click the button [ + ] to add a new module
4. Click the button [Edit] to enter the Module Content Setting page  
Set up the Modbus Mapping Table for the UA controller and module I/O channels

The function items and setting parameters of the [Modbus ASCII Module List]:

### Modbus ASCII Module List

Serial Port COM4 ▾

Select All	No.	*Module Name / Nickname	Edit
<input type="checkbox"/>	2 ▾	Name <input style="width: 150px;" type="text"/>	
<input type="checkbox"/>	1	Name	<input type="button" value="Edit"/>

< 1 / 1 >

Module Setting > Modbus - ASCII Module (Master) > Modbus ASCII Module List	
Serial Port	Choose the serial port of UA controller that links with the I/O module. UA-2800: COM2 (RS-232); COM3 (RS-485); COM4 (RS-485) Select the port that the module is actually connected to.
<input type="button" value="⊕"/>	Click to add a list of module.
<input type="checkbox"/>	Check the box in the left of the module is to select that module list, can delete or copy the module. Check the box "Select All" will select all modules in the list.
No.	The module number in the module list (System arrange, not editable)
*Module Name / Nickname	Module name or nick name. User can give a new name. (The star * means this field cannot be null.)
Edit	Click to set the module in the Module Content Setting page.
Copy	Select the module wants to copy by check the box and click [Copy] can copy module by assigning port and Quantity. Yes: copy the module and exit. No: exit without copy.
Remove	Click to delete the checked module(s)
Remove all	Click to delete all modules linked with the selected port. Remove: delete the modules and exit. No: exit without delete module.
<input type="button" value="&lt; 1 / 1 &gt;"/>	The page number / total pages of the module list. Click < or > to go to the previous or the next page.
Save	Click to save the settings of this page.

**Copy module**

Copy to : ttyO5 ▾

Quantity :

**Remove module**

Select : ttyO2 ▾

Click [Edit] button to enter the "Module Content Setting" page.

(Master) Module Content Setting

### Module Content Setting

No.	1
Module Name	Name
Slave ID	1
Timeout	500

### Modbus Mapping Table Setting

Data Model	01 Coil Status(0x)
Start Address	0
Data Number	1
Create Tables	<input type="button" value="Add"/>

**> Modbus Mapping Table Setting:**

Set module in the order of Data Model, Start Address and Data Number, then click "Add".

**Ex:** Module has 6 Data Models of "04 Input Registers (3x)" (Mapping: AI), so select Model "04", start 0, number 6, type Short, and click "Add".

Input Registers(3x)	
Address	0
Number	6
Type	Short
<input type="button" value="Edit"/>	

Module Content Setting			
No.	The module number in the module list (Not editable here)		
Module Name	Give a name, e.g. model number or name. Default: Name.		
Slave ID	Set the module Slave ID of the UA. (Range: 1 ~ 247)		
Timeout	Set the timeout value for the module. Default: 500 ms		
Modbus Mapping Table Setting			
Data Model	System provides 4 Modbus data models for mapping to the Modbus address of the Ch.: Coil Status, Input Status, Holding Registers, Input Registers.	Data Model	Modbus Addr.Ch. Type
		Coil Status	0xxxxx DO
		Input Status	1xxxxx DI
		Holding Registers	2xxxxx AO
Input Registers	3xxxxx AI		
Start Address	The start address of the Modbus command. <b>Note:</b> the Start Address of UA is base 0, even if some modules are base 1, here it needs to follow UA to set base 0.		
Data Number	Set the number of module channel (DO, DI, AO, AI) data according to "Data Model". Default: 1.		
Type	This item only appears when the data model is 03 or 04. Set it according to the module data: 16-bit Short, 16-bit Unsigned Short, 32-bit Long, 32-bit Unsigned Long, 64-bit Int64, 32-bit Float, 64-bit Double. <b>Note:</b> 32-bit and 64-bit data occupy 2 and 4 Modbus Register addresses.		
Create Tables	Click [Add] button, it will add a table in the Modbus mapping table.		

The finished Modbus Mapping Table as below is in order of DO, DI, AO and AI.

**Address Setting:**

Display and edit the Modbus Mapping Table.

Modbus Mapping Table		Address Setting		Nickname Setting			
Coil Status(0x)		Input Status(1x)		Holding Registers(4x)		Input Registers(3x)	
Address	0	Address	<input type="text" value="0"/>	Address	0	Address	0
Number	2	Number	<input type="text" value="1"/>	Number	1	Number	1
Type	Bool	Type	Bool	Type	Short	Type	Float
<input type="button" value="Edit"/>		<input type="button" value="Delete"/> <input type="button" value="Save"/>		<input type="button" value="Edit"/>		<input type="button" value="Edit"/>	
		<input type="button" value="Cancel"/>					
Press Save to finish editing.							
<input type="button" value="OK"/>				<input type="button" value="Cancel"/>			

Modbus Mapping Table – Address Setting	
Address Setting	The “Address Setting” page of the Modbus Mapping Table
Nickname Setting	Click can switch to the The “Nickname Setting” page of the Modbus Mapping Table. (Next page)
Modbus Mapping Table	Coil Status(0x): Mapping to DO Modbus address Input Status(1x): Mapping to DI Modbus address Holding Registers(4x): Mapping to AO Modbus address Input Registers(3x): Mapping to AI Modbus address
Address	The start address of the Modbus command. Default: 0. <b>Note:</b> the Start Address of UA is base 0, even if some modules are base 1, here it needs to follow UA to set base 0.
Number	The number of the Modbus address. Need to give enough number for the DO, DI, AO, AI channels of the module. At least 1.
Type	DO/DI type: Bool (Boolean) AO/AI type: depend on setting of [Modbus Mapping Table Setting]
Edit	Click to change the address and Number.
Delete	Click to delete this address table.
Save	Click to save and exit this table editing.
Cancel	Click to exit without saving and back to the module list page.
OK	Click to save this page settings and back to the module list page.

**Nickname Setting:**

Setting the variable nickname and description.

Modbus Mapping Table		Address Setting	Nickname Setting	
<b>01 Coil Status(0x)</b>				
Table Display		<input type="button" value="Show"/>	<input type="button" value="Hide"/>	
Address	Variable name	Data Type	Description	
0	<input type="text" value="Tag0"/>	Bool	<input type="text"/>	
1	<input type="text" value="Tag1"/>	Bool	<input type="text"/>	
<b>02 Input Status(1x)</b>				
Table Display		<input type="button" value="Show"/>	<input type="button" value="Hide"/>	
Address	Variable name	Data Type	Description	
0	<input type="text" value="Tag0"/>	Bool	<input type="text"/>	
<b>03 Holding Registers(4x)</b>				
Table Display		<input type="button" value="Show"/>	<input type="button" value="Hide"/>	
Address	Variable name	Data Type	Swap	Description
0	<input type="text" value="Tag0"/>	Short	<input type="checkbox"/>	<input type="text"/>
<b>04 Input Registers(3x)</b>				
Table Display		<input type="button" value="Show"/>	<input type="button" value="Hide"/>	
Address	Variable name	Data Type	Swap	Description
0	<input type="text" value="Tag0"/>	Float	<input type="checkbox"/>	<input type="text"/>
		<input type="button" value="OK"/>	<input type="button" value="Cancel"/>	

Modbus Mapping Table – Nickname Setting	
Modbus Mapping Table	Coil Status(0x): Mapping to DO Modbus address Input Status(1x): Mapping to DI Modbus address Holding Registers(4x): Mapping to AO Modbus address Input Registers(3x): Mapping to AI Modbus address
Table Display	Click [Show] to display all fields, click [Hide] to hide some fields.
Address	Modbus address. System auto arrange.
Variable name	The variable name of the mapping address. Default: Tag0 and auto arrange the number. User can define the name.
Data Type	Display data type of the variable. (Not editable)
Swap	Check to swap the byte order (Lo-Hi/Hi-Lo) for 4-byte or 8-byte.
Description	Write a note for this variable.
OK	Click to save this page settings and back to the module list page.

### 5.2.4 MQTT Module

This setting is for UA Controller connecting the remote MQTT module.

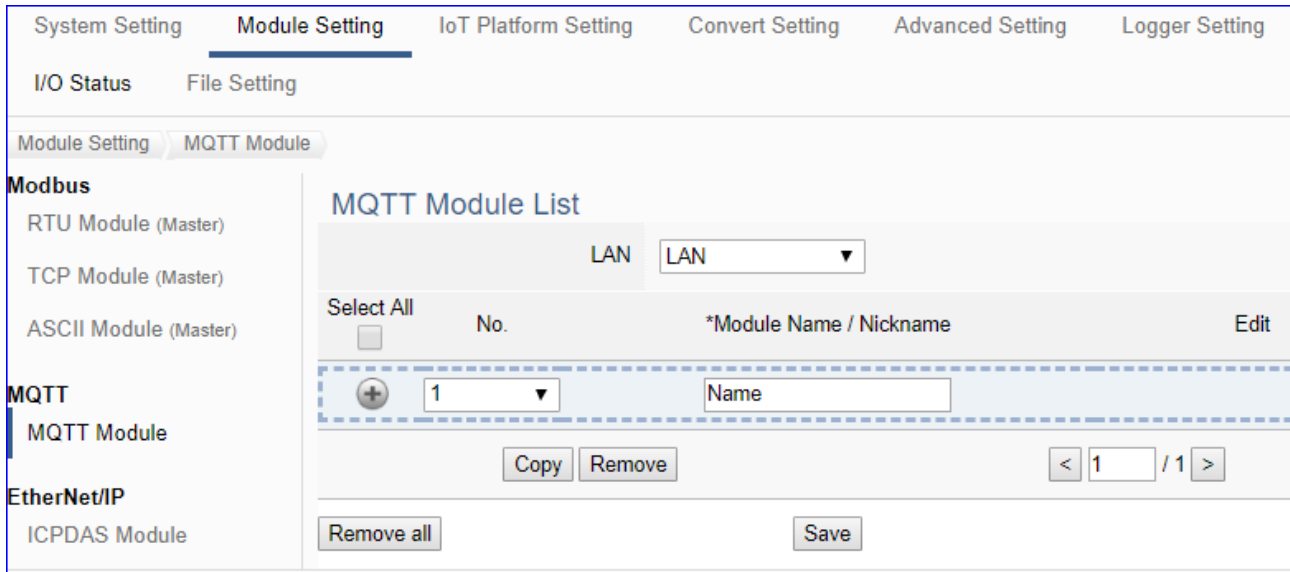

This page is for setting the communication values with the connected modules. First choose the Ethernet LAN port that connected with the module, and each module can give a name (Default name: Name). Click [ + ] button could add a new module, and then click [Edit] button to configure the module content and the MQTT variable table.

#### Setting Steps:

1. Give the module name or nickname, e.g. MQ-7255, DL-302. Default: Name
2. Click the button [ + ] to add a new module
3. Click the button [Edit] to enter the Module Content Setting page  
Set up the Modbus Mapping Table for the UA controller and module I/O channels

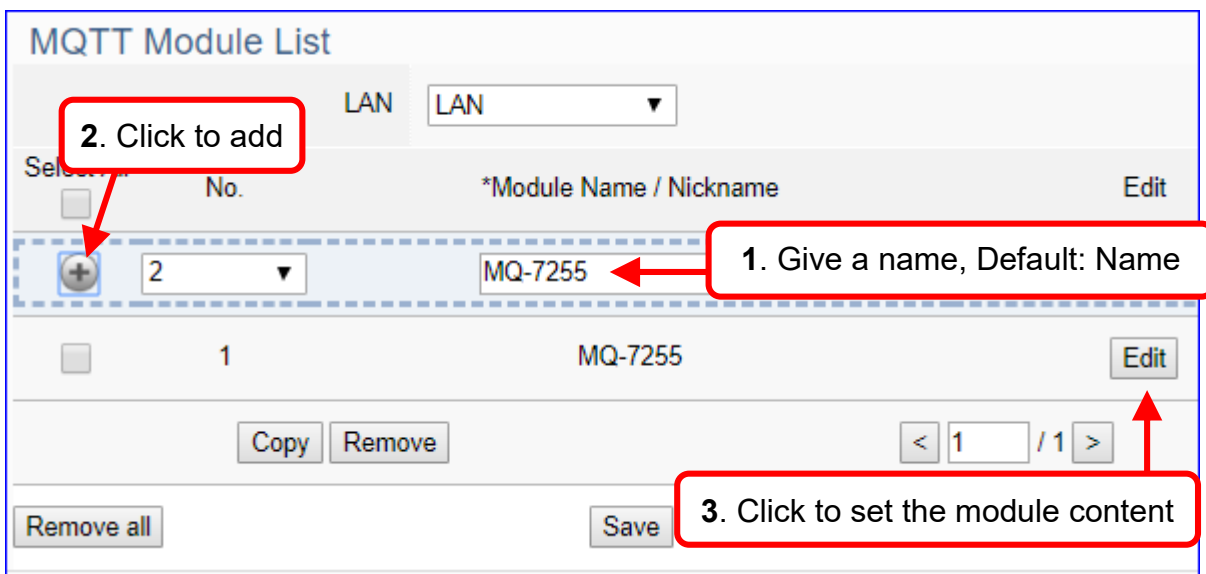

The function items and setting parameters of the [MQTT Module List]:

Module Setting > MQTT - MQTT Module > MQTT Module List		
	Click to add a list of module.	
<input type="checkbox"/>	Check the box in the left of the module is to select that module list, can delete or copy the module. Check the box "Select All" will select all modules in the list.	
No.	The module number in the module list (System arrange, not editable)	
*Module Name / Nickname	Module name or nick name. User can give a new name. (The star * means this field cannot be null.)	
Edit	Click to set the module in the Module Content Setting page.	
Copy	Select the module wants to copy by check the box and click [Copy] can copy module by assigning port and quantity. Yes: copy the module and exit. No: exit without copy.	
Remove	Click to delete the checked module(s)	
Remove all	Click to delete all modules linked with the selected port. Remove: delete the modules and exit. No: exit without delete module.	
	The page number / total pages of the module list. Click < or > to go to the previous or the next page.	
Save	Click to save the settings of this page.	

Click [**Edit**] can enter the [**MQTT Client Setting**] page.

[MQTT Client Setting] page: to set up the module and the variable table

MQTT Client Setting	
No.	<input type="text" value="1"/>
Module Name	<input type="text" value="MQ-7255"/>
MQTT Connection	<input checked="" type="radio"/> Broker (Local)
MQTT Variable Setting	
Attribute	<input type="text" value="Read"/>
Data Type	<input type="text" value="Bool"/>
Data Number	<input type="text" value="1"/>
Create Tables	<input type="button" value="Add"/>
Details	<input type="button" value="Show"/> <input type="button" value="Hide"/>

MQTT Client Setting	
No.	The module number in the module list (Not editable here)
Module Name	Give a name, e.g. model number or name. Default: Name.
MQTT Connection	Broker (Local): The using Local Broker. Broker Name (Remote) will be another option if there is another Remote Broker setting.
MQTT Variable Setting	
Attribute	Display data attribute of the variable. (Not editable) Include: Read, Read/Write...
Data Type	Display data type of the MQTT variable. Include: Bool, Short, Unsigned Short, Long, Unsigned Long, Int64, Float, Double, String.
Data Number	The number for the I/O variables of the module. Default: 1.
Create Tables	Click [Add] button, it will add a variable list in the MQTT Variable Table.
Details Show / Hide	Click [Show] to display all fields, click [Hide] to hide some fields. The hide fields: Subscribe QoS, Publish QoS, Retain.

**[MQTT Variable Table] :**

MQTT Variable Table	
Details Show / Hide	Click [Show] to display all fields, click [Hide] to hide some fields. The hide fields: Subscribe QoS, Publish QoS and Retain.
Remove Table / Remove	Check the box in the left of the variable is to select that variable list, and click the “remove” on the box can delete that variable list. Click the “Remove” of the “Remove Table” will delete all lists.
Name	The name of the MQTT variable. Default: Tag#
Attribute	Display data attribute of the variable. (Not editable) Include: Read, Read/Write...
Data Type	Display data type of the variable. Include: Bool, Short, Unsigned Short, Long, Unsigned Long, Int64, Float, Double, String
Subscribe Topic	The topic of receiving/subscribing data message.
Subscribe QoS	The subscribe QoS (Quality of Service) levels. Default: 2 0: Delivering a message at most once. 1: Delivering a message at least once. 2: Delivering a message at exactly once.
Publish Topic	The topic of sending/publishing data message.
Publish QoS	The publish QoS (Quality of Service) levels. Default: 2 0: Delivering a message at most once. 1: Delivering a message at least once. 2: Delivering a message at exactly once.
Description	For users set up the description for the variables.
Retain	Check [Retain] box of the top row can store the broker message for all variables in list. Check the box of each variable can store the broker message just that variable. Default: Uncheck.
OK / Cancer	Click [OK] to save and exit the page settings. Click [Cancer] to exit without saving.

### 5.2.5 EtherNet/IP ICP DAS Module

This setting is for UA Controller connecting the remote ICP DAS EIP module.

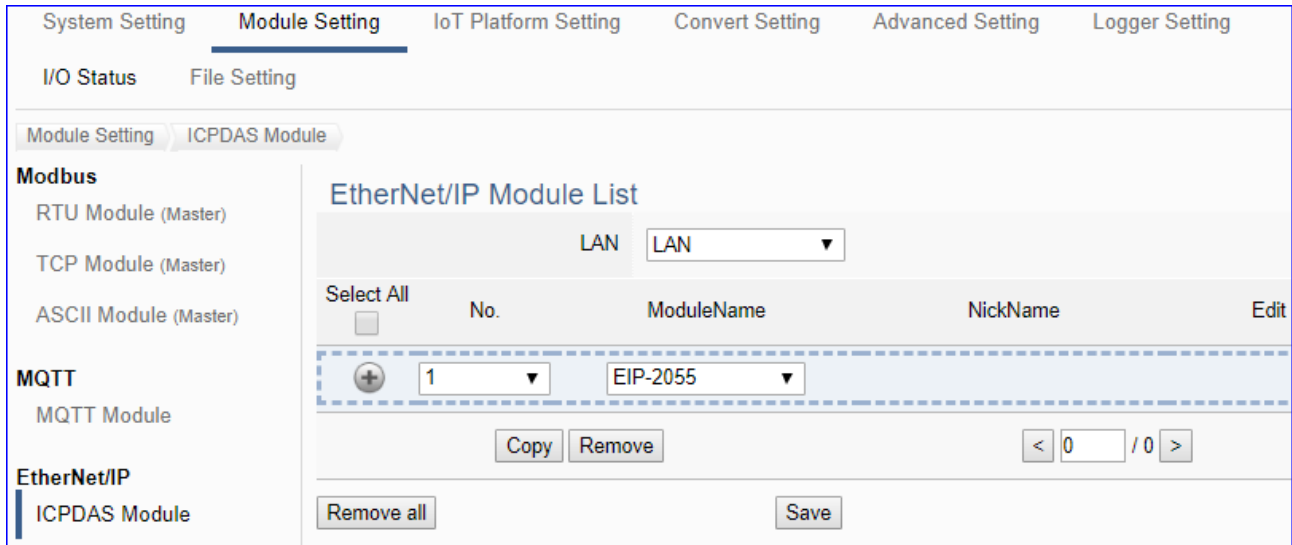

This page is for setting the communication values with the connected EIP modules. First, choose the Ethernet LAN port that connected with the module, and select the name of EIP module. Click [ + ] button could add a new module, and then click [Edit] button to configure the module content and the MQTT variable table.

#### Setting Steps:

1. Select the module name of EIP-2000
2. Click the button [ + ] to add a new module
3. Click the button [Edit] to enter the Module Content Setting page  
Set up the module IP and module I/O channels

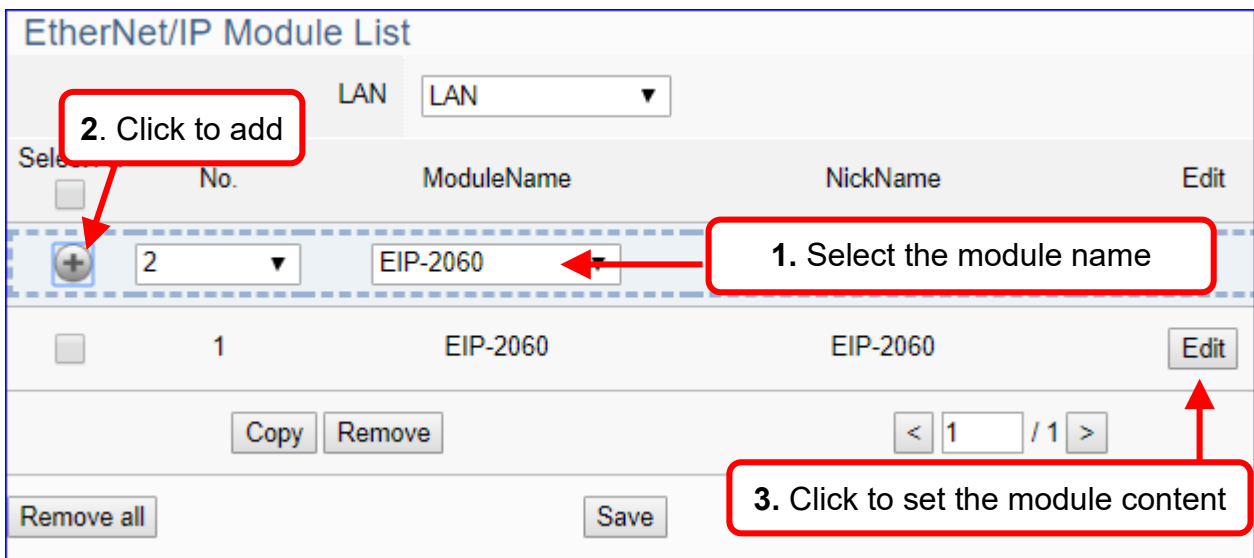

The function items and setting parameters of the [EtherNet/IP Module List]:

Module Setting > EtherNet/IP – ICPDAS Module > EtherNet/IP Module List	
Select All <input type="checkbox"/>	Check the box in the left of the module is to select that module list, can delete or copy the module. Check the box “Select All” will select all modules in the list.
<input type="button" value="+"/>	Click to add a list of module.
No.	The module number in the module list (System arrange, not editable)
ModuleName	Select the connecting EIP-2000 module name.
NickName	User can define a nickname for the EIP-2000 module.
Edit	Click to set the module in the Module Content Setting page.
Copy	Select the module wants to copy by check the box and click [Copy] can copy module by assigning port and quantity. Yes: copy the module and exit. No: exit without copy.
Remove	Click to delete the checked module(s)
Remove all	Click to delete all modules linked with the selected port. Remove: delete the modules and exit. No: exit without delete module.
<input type="button" value="&lt; 1 / 1 &gt;"/>	The page number / total pages of the module list. Click < or > to go to the previous or the next page.
Save	Click to save the settings of this page.

Click [Edit] can enter the [Module Content Setting] page to set up the module.

[Module Content Setting] page:

Module Content Setting	
No.	<input type="text" value="1"/>
Module Name	<input type="text" value="EIP-2060"/>
NickName	<input type="text" value="EIP-2060"/>
IP	<input type="text" value="0"/> . <input type="text" value="0"/> . <input type="text" value="0"/> . <input type="text" value="0"/>
ChannelNumber	<input type="text" value="12-ch(6DI+6DO)"/>

Module Setting > EtherNet/IP – ICPDAS Module > Module Content Setting	
No.	The module number in the module list (Not editable here)
Module Name	The selected EIP module number.
NickName	User can define a nickname for the module. Default: Module name.
IP	Enter the IP address of the module. Default: 0.0.0.0
ChannelNumber	System auto setup the I/O channel numbers and the I/O table. Some module provides 2 or more channel mode needed user to select one.

DI/DO/AI/AO Channel Table: System auto setup the table according to the module name.

Digital Input				
Channel	Name	Attributes	Data Type	Description
0	<input type="text" value="DI0"/>	<input type="text" value="Read"/> ▼	Bool	<input type="text"/>

Digital Output				
Channel	Name	Attributes	Data Type	Description
0	<input type="text" value="DO0"/>	<input type="text" value="Read / Write"/> ▼	Bool	<input type="text"/>

Analogy Input				
Channel	Name	Attributes	Data Type	Description
0	<input type="text" value="AI0"/>	<input type="text" value="Read"/> ▼	Float	<input type="text"/>

Analogy Output				
Channel	Name	Attributes	Data Type	Description
<input type="button" value="OK"/> <input type="button" value="Cancel"/>				

Module Setting > EtherNet/IP – ICPDAS Module > Di/Do/AI/AO Channel Table	
Channel	Channel number set by system. (Not editable)
Name	Channel name. User can define a new channel name.
Attribute	Display data attribute of the channel. (Not editable) Include: Read, Read / Write...
Data Type	Display data type of the channel. Include: Bool, Short, Float, ... according to the module.
Description	User can set up the description for the channel.
OK / Cancer	Click [OK] to save and exit the page settings. Click [Cancer] to exit without saving.

## 5.2.6 XV Module

This function can set the XV Board module on the expansion slot of the UA server. The user inserts the XV board into the UA slot and uses this function to select and set the XV module.

UA-2800 series provides one **XV expansion board slot**. Users can purchase one **XV511i** module to expand 4 RS-485 ports. Or, One of **XV107/110/111/116/119/303/306/307/310** modules to expand the I/O channel.

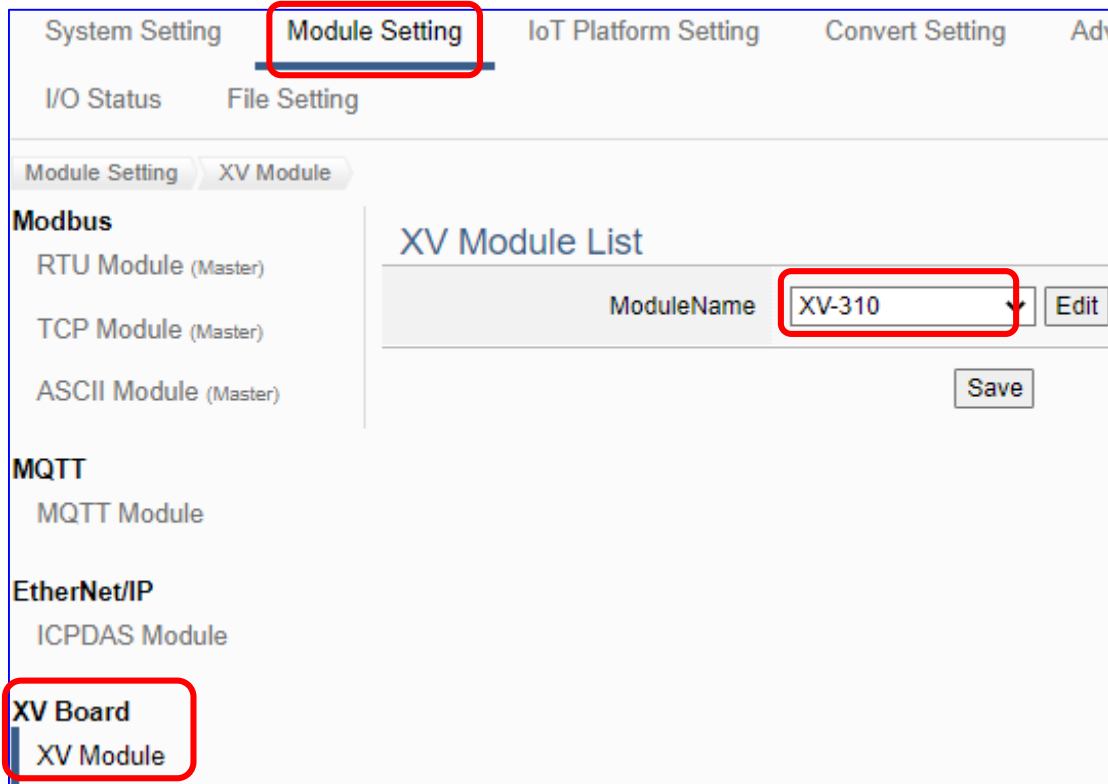

Module Setting > XV Board – XV Module > XV Module List	
Module Name	Displays the model number of the module listed in the drop-down menu. Default: None.
Edit	Edit selected module content.

Select the module name, and click "Edit".

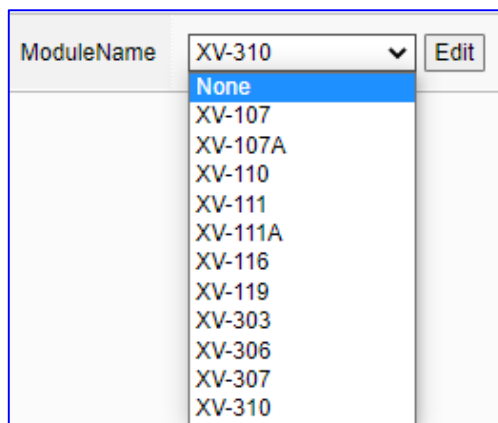

Module Content Setting	
Module Name	<input type="text" value="XV-310"/>
NickName	<input type="text" value="XV-310"/>

**Module Setting > XV Board – XV Module > XV Module List > Module Content Setting**

Module Name	Display the current module name
Nick Name	Display/edit the nick name of the current module (default: current module name)

Digital Input		
Channel	Name	Description
0	<input type="text" value="DI0"/>	<input type="text"/>
1	<input type="text" value="DI1"/>	<input type="text"/>
2	<input type="text" value="DI2"/>	<input type="text"/>

Digital Input Counter			
Channel	Name	Counter Type	Description
0	<input type="text" value="Counter0"/>	<input type="text" value="Falling"/>	<input type="text"/>
1	<input type="text" value="Counter1"/>	<input type="text" value="Falling"/>	<input type="text"/>
2	<input type="text" value="Counter2"/>	<input type="text" value="Falling"/>	<input type="text"/>

**Module Setting > XV Board – XV Module > XV Module List > Digital Input (Counter)**

Channel	Display the current channel number
Name	Display/edit the current channel name (default: DI0, 1, 2... or Counter0, 1, 2...)
Counter Type	Set the trigger counting type of the Counter. Select Falling or Rising (default: Falling)
Description	Display and edit current channel descriptions (user defined)

Digital Output			
Channel	Name	PowerOn Value	Description
0	<input type="text" value="DO0"/>	<input type="button" value="OFF"/> ▾	<input type="text"/>
1	<input type="text" value="DO1"/>	<input type="button" value="OFF"/> ▾	<input type="text"/>

**Module Setting > XV Board – XV Module > XV Module List > Digital Input (Counter)**

Channel	Display the current channel number
Name	Display/edit the current channel name (default: DO0, 1, 2...)
PowerOn Value	Set the DO channel power-on default value. Select ON or OFF (default: OFF)
Description	Display and edit current channel descriptions (user defined)

Analogy Input			
Channel	Name	Type	Description
0	<input type="text" value="AI0"/>	<input type="button" value="-10 V ~ 10 V"/> ▾	<input type="text"/>
1	<input type="text" value="AI1"/>	<input type="button" value="-10 V ~ 10 V"/> ▾	<input type="text"/>
2	<input type="text" value="AI2"/>	<input type="button" value="-10 V ~ 10 V"/> ▾	<input type="text"/>
3	<input type="text" value="AI3"/>	<input type="button" value="-10 V ~ 10 V"/> ▾	<input type="text"/>

Analogy Output				
Channel	Name	Type	PowerOn Value	Description
0	<input type="text" value="AO0"/>	<input type="button" value="0 V ~ 10 V"/> ▾	<input type="text" value="0"/>	<input type="text"/>
1	<input type="text" value="AO1"/>	<input type="button" value="0 V ~ 10 V"/> ▾	<input type="text" value="0"/>	<input type="text" value="1"/>

**Module Setting > XV Board – XV Module > XV Module List > Analogy Input / Output**

Channel	Display the current channel number
Name	Display/edit the current channel name (default: AO0, 1... or AO0, 1...)
Type	Set AI/AO channel signal type (default: -10V~10V)
PowerOn Value	Set the AO channel power-on default value. (default: 0)
Description	Display and edit current channel descriptions (user defined)

## 5.2.7 Internal Module

The function can create internal modules and variables for virtual reading and writing, or as an intermediary to provide data exchange of communication protocols.

1. Internal Variable: max. 8 internal modules; max. 100 internal variables (tags) per module.
2. Protocol Communication Conversion: provide Internal to OPC UA (Server)

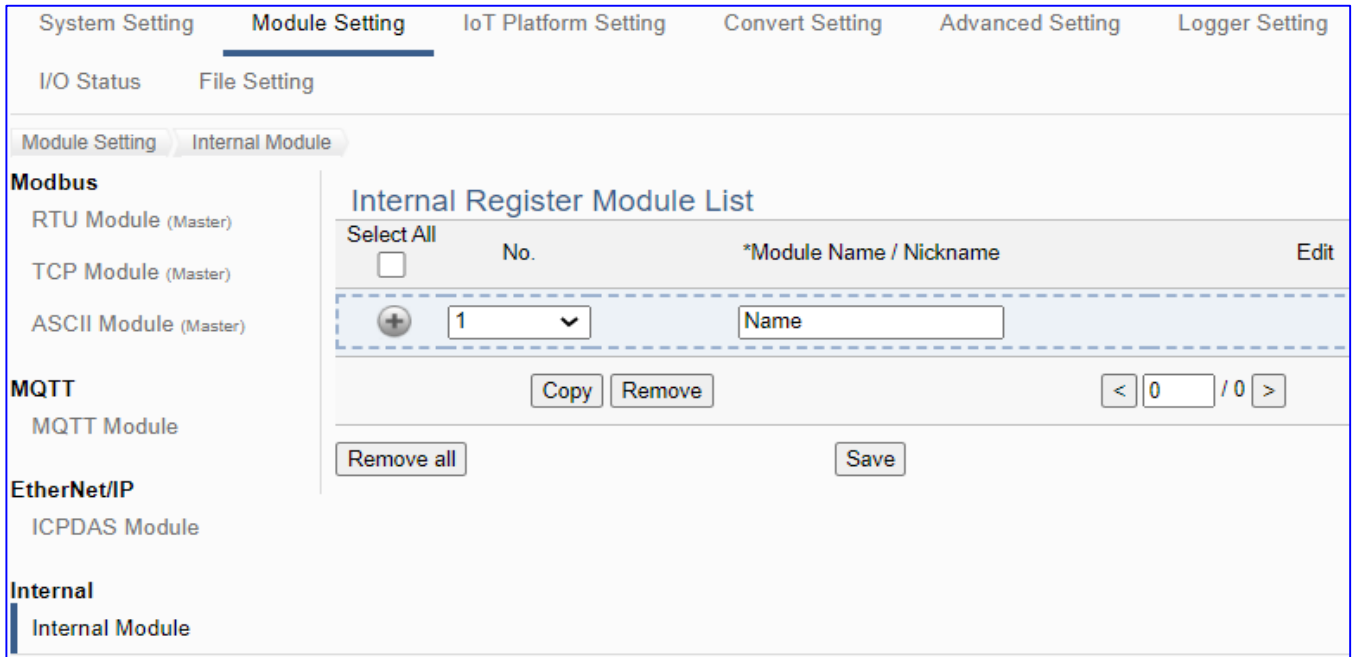

This page is for setting the internal module list. First, enter the name for the module. Click [ + ] button to add a new module, and then click [Edit] button to configure the module variables.

### Setting Steps:

1. Enter a name for the internal module
2. Click the button [ + ] to add the module
3. Click the button [Edit] to enter the Module Content Setting page.  
Set up the module variables

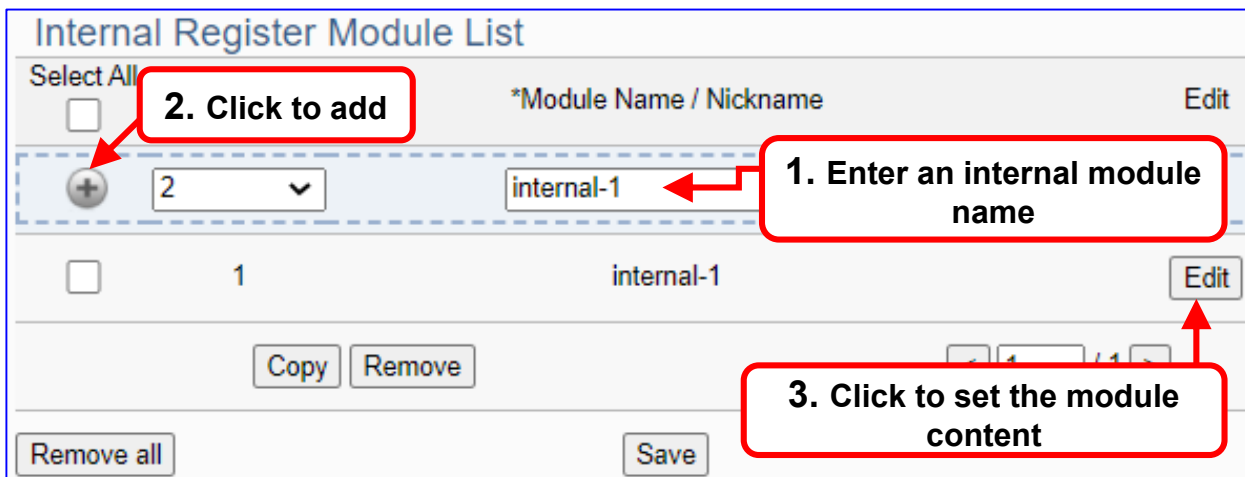

The function items and setting parameters of the [Internal Register Module List]:

Module Setting > Internal – Internal Module > Internal Register Module List		
Select All <input type="checkbox"/>	Check the box “Select All” will select all modules in the list. Check the box in the left of the module is to select that module list, can delete or copy the module.	
	Click to add a list of module.	
No.	The module number in the module list (System arrange, not editable)	
*Module Name / Nickname	Module name or nickname. User can give a new name. (The star * means this field cannot be null.)	
Edit	Click to set the module in the Module Content Setting page.	
Copy	Select the module wants to copy by check the box and click [Copy] can copy module by assigning port and quantity. Yes: copy the module and exit. No: exit without copy.	
Remove	Click to delete the checked module(s)	
Remove all	Click to delete all modules linked with the selected port. Remove: delete the modules and exit. No: exit without delete module.	
	The page number / total pages of the module list. Click < or > to go to the previous or the next page.	
Save	Click to save the settings of this page.	

Click [**Edit**] can enter the [**Internal Module Content Setting**] page.

[Internal Module Content Setting] page: to set up the module and the variable table

### Internal Module Content Setting

No.	<input type="text" value="1"/>
Module name	<input type="text" value="Internal-1"/>

### Internal Variable Setting

Attribute	<input type="text" value="Read / Write"/>
Data Type	<input type="text" value="Bool"/>
Data Number	<input type="text" value="1"/>
Create Tables	<input type="button" value="Add"/>

**> Internal Variable Table:**  
 Sequentially select the Attribute, Data Type, and Data Number of the variable, and then click [Add].

**EX:** Internal-1 has 2 "Bool" type variables, then select Type "Bool", Number "2", then click [Add]. If user needs other variables, please add more variables by your case.

Internal Module Content Setting	
No.	The module number in the module list (Not editable here)
Module Name	Give a name, e.g. model number or name.
Internal Variable Setting	
Attribute	Display data attribute of the variable. (Not editable) Include: Read/Write...
Data Type	Display data type of the MQTT variable. Include: Bool, Short, Unsigned Short, Long, Unsigned Long, Float, Double, String.
Data Number	The number for the I/O variables of the module. Default: 1.
Create Tables	Click [Add] button, it will add a variable list in the Variable Table.

The Internal Variable Table is as below.

### Internal Variable Table

Remove Tables

	No.	Name	Attribute	Data Type	Description
<input type="checkbox"/>	1	<input type="text" value="Tag0"/>	<input type="text" value="Read / Write"/>	Bool	<input type="text"/>
<input type="checkbox"/>	2	<input type="text" value="Tag1"/>	<input type="text" value="Read / Write"/>	Bool	<input type="text"/>
<input type="checkbox"/>	3	<input type="text" value="Tag2"/>	<input type="text" value="Read / Write"/>	String	<input type="text"/>
<input type="checkbox"/>	4	<input type="text" value="Tag3"/>	<input type="text" value="Read / Write"/>	String	<input type="text"/>

**[Internal Variable Table] :**

Internal Variable Table					
Remove Tables		<input type="button" value="Remove"/>			
<input type="button" value="Remove"/>	No.	Name	Attribute	Data Type	Description
<input type="checkbox"/>	1	<input type="text" value="Tag0"/>	Read / Write ▾	Bool	<input type="text"/>
<input type="checkbox"/>	2	<input type="text" value="Tag1"/>	Read / Write ▾	Bool	<input type="text"/>
<input type="checkbox"/>	3	<input type="text" value="Tag2"/>	Read / Write ▾	String	<input type="text"/>
<input type="checkbox"/>	4	<input type="text" value="Tag3"/>	Read / Write ▾	String	<input type="text"/>
		<input type="button" value="OK"/> <input type="button" value="Cancel"/>			

Internal Variable Table	
Remove Table / Remove	Check the box in the left of the variable is to select that variable list, and click the “remove” on the box can delete that variable list. Click the “Remove” of the “Remove Table” will delete all lists.
No.	The module number in the module list (Not editable here)
Name	The name of the variable. Default: Tag#
Attribute	Display data attribute of the variable. (Not editable) Include: Read/Write...
Data Type	Display data type of the variable. Include: Bool, Short, Unsigned Short, Long, Unsigned Long, Int64, Float, Double, String (Not editable)
Description	For users set up the description for the variables.
OK / Cancer	Click [OK] to save and exit the page settings. Click [Cancer] to exit without saving.

### 5.3 Main Menu: IoT Platform Setting

UA series can connect to Amazon AWS, IBM Bluemix, Microsoft Azure or other IoT Cloud platforms. The Azure connection is more complicated and will set up in another setting item.

**IoT Platform Setting** is the third item of the Main Menu. It manages the interaction of the UA series connecting with the host computer in the Internet of Things. It provides OPC UA and MQTT protocols connection services via the Ethernet interface for data transmission.

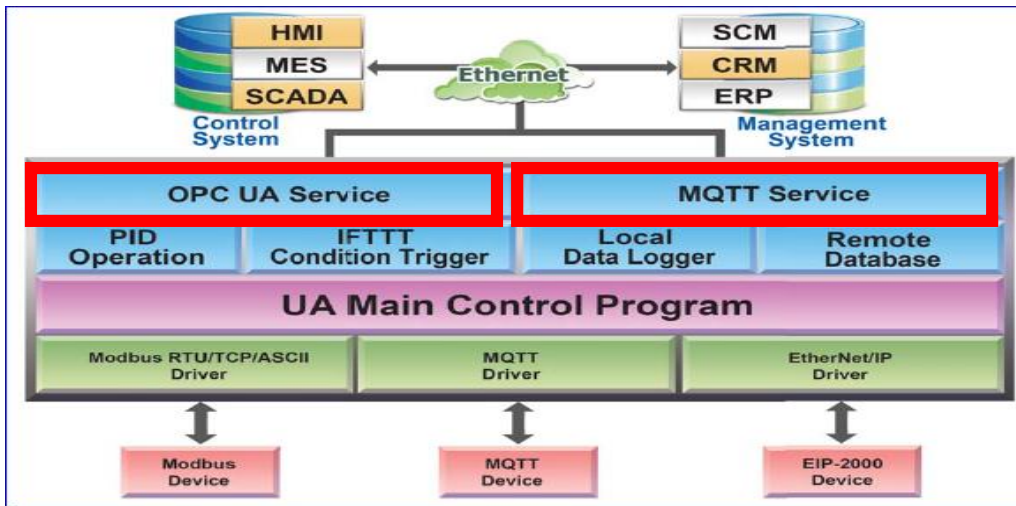

[IoT Platform Setting] includes five sub-menu functions in MQTT and OPC UA two connections and the function descriptions are listed on the page of the Main Menu, such as the Local Broker, Remote Broker, MQTT Group Connection and Microsoft Azure Platform in the MQTT Connection category, and the Local Server in the OPC UA Connection category. This chapter will introduce these function items and setting parameters.

System Setting    Module Setting    **IoT Platform Setting**    Convert Setting    Advanced Setting    Logger Setting

I/O Status    File Setting

IoT Platform Setting

**MQTT Connection**

- Local Broker
- Remote Broker
- MQTT Group Connection
- Microsoft Azure Platform

**OPC UA Connection**

- Local Server

IoT Platform Setting		
<b>MQTT Connection</b>		
Local Broker		This setting provides to build a user MQTT Broker via the built-in MQTT Broker service of the controller.
Remote Broker		This function can set up the MQTT connection with the remote Broker. User can publish and subscribe messages to the remote Broker through this connection.
MQTT Group Connection		This function can set up the MQTT connection with local and remote brokers. Setting with the MQTT JSON function in the Convert Transmission, It can make the I/O module messages in groups and then mapping to the user-defined publish and subscribe topics.
Microsoft Azure Platform		The system features the connection ability to the Microsoft Azure platform. It allows users to publish messages to Microsoft Azure and receive messages from Microsoft Azure.
<b>OPC UA Connection</b>		
Local Server		This function provides the settings for the OPC UA Server.

### 5.3.1 MQTT Local Broker

UA series controller built-in MQTT Broker that compliance with MQTT v3.1.1 protocol and supporting MQTT message distribution management. When using MQTT communication, there is no need to build a new Broker system.

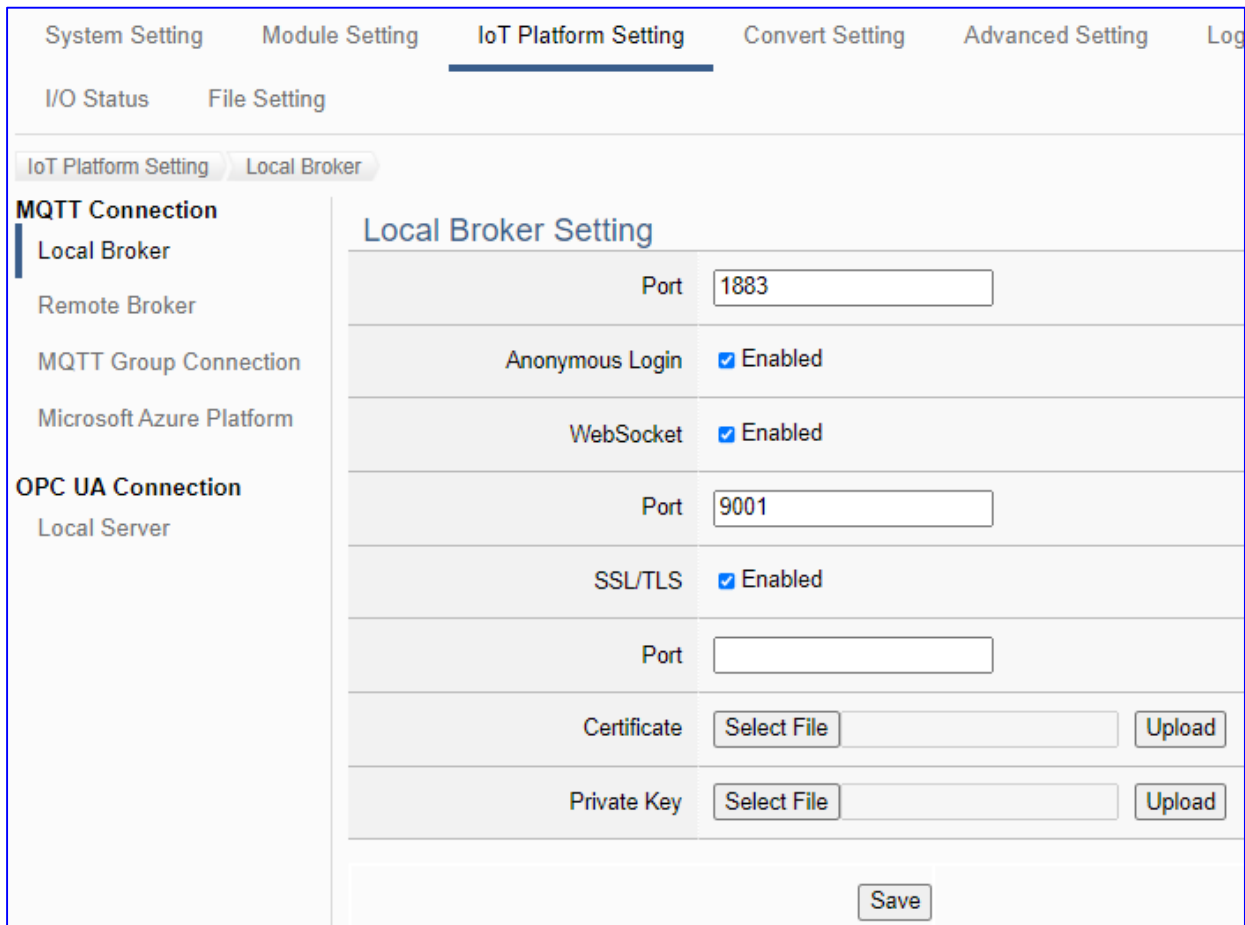

MQTT Connection > Local Broker Setting	
Port	MQTT Local Broker’s COM port. System default: 1883
Anonymous Login	Check to allow anonymous login. Default: Check Enabled.
WebSocket	Check to enable MQTT Broker WebSocket communication
Port	Set WebSocket port
SSL/TLS	Check to enable MQTT Broker SSL/TLS communication
Port	Set SSL/TLS port
Certificate	The Certificate required for MQTT Broker SSL/TLS communication. The user clicks Select File to select the certificate file to be uploaded on the browser side. Then click Upload to upload the file.
Private Key	The Private Key required for MQTT Broker SSL/TLS communication. The user clicks Select File to select the certificate file to be uploaded on the browser side. Then click Upload to upload the file.
Save	Click to save the settings of this page.

### 5.3.2 MQTT Remote Broker

UA series can connect to Amazon AWS, IBM Bluemix, Microsoft Azure or other IoT Cloud platforms. The Azure connection is more complicated and will set up in another setting item.

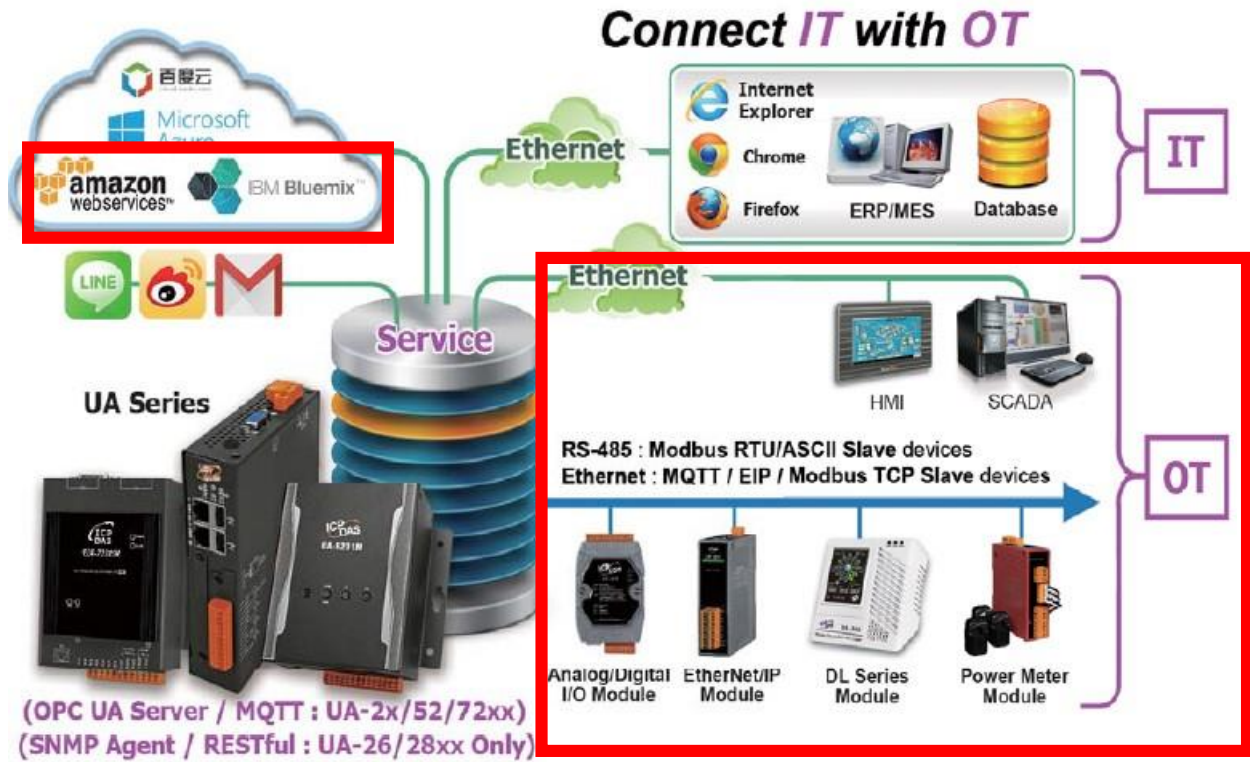

UA series controller built-in MQTT Broker, but when users want to use the external MQTT Broker, UA system also provides the settings to connect and publish/subscript messages with the MQTT Remote Broker.

This page can set up the MQTT connection with the remote Broker. User can publish and subscribe messages to the remote Broker through this connection.

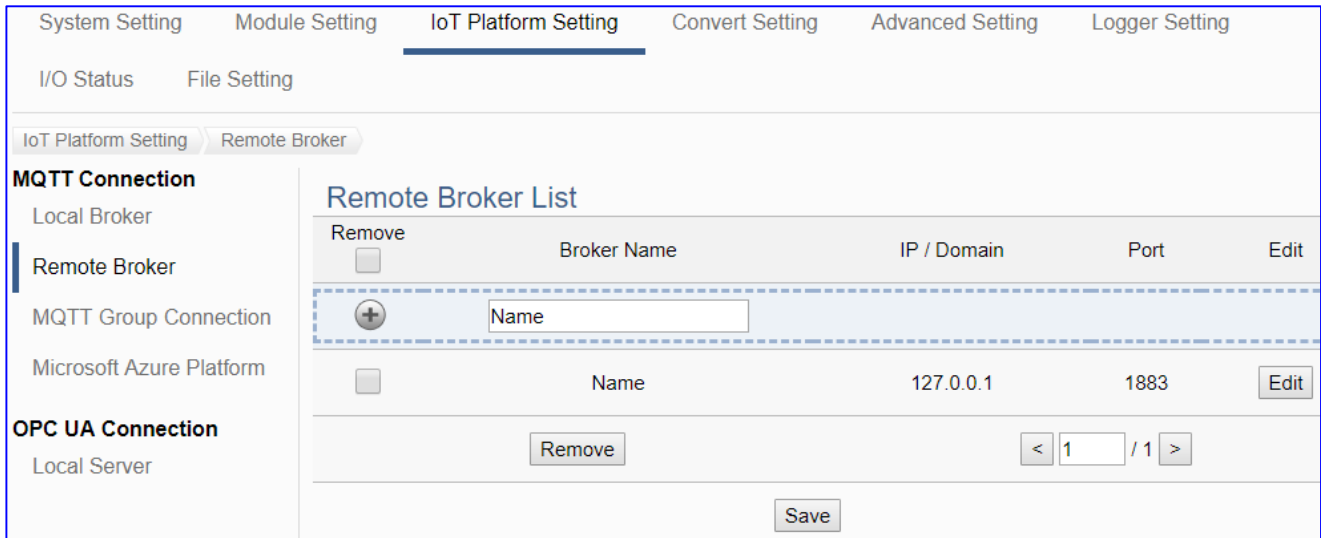

**Setting Sequence for the MQTT Connection:**

1. Add and set up a connection Broker name in the Remote Broker List.
2. Set up the contents of the Topic messages published/subscribed by other external MQTT devices for mapping to the Variables Table of the UA controller.
3. Convert the data contents of the MQTT device to communicate with other protocols.

For the certificate about the communication security, please refer to [Chapter 7](#).

This section will introduce the function items and setting parameters.



**MQTT Connection > Remote Broker > Remote Broker List**

Broker Name	MQTT Remote Broker name. User can give a new name, e.g. Broker1. Default: Name.
	Click to add a list of remote Broker.
Save	Click to save the settings of this page.

After adding a list of the Remote Broker:

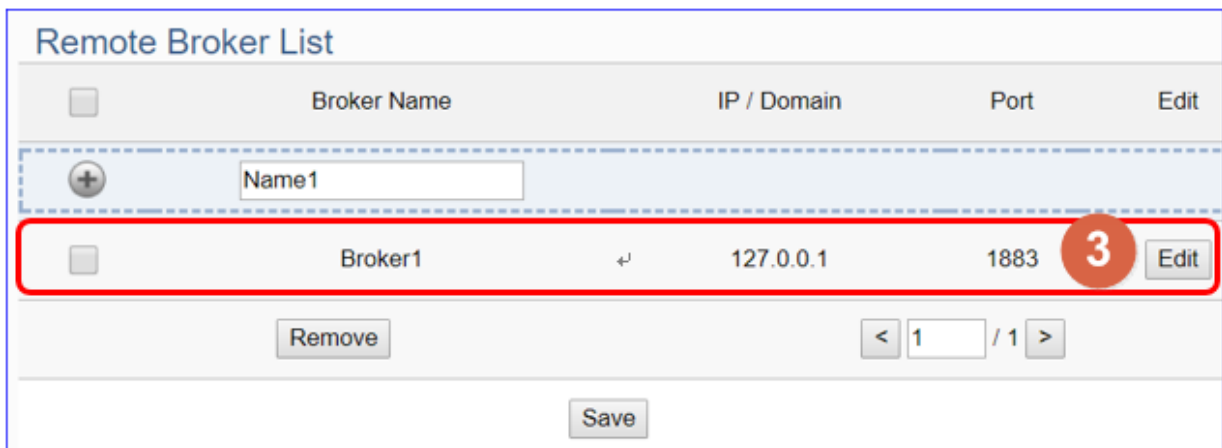

**MQTT Connection > Remote Broker > Remote Broker List**

Broker Name	The MQTT remote Broker name.
IP / Domain	The IP address or domain name of the remote Broker.
Port	The communication port of the remote Broker.
<input type="checkbox"/>	Check the box in the left of the Broker is to select that Broker, can delete or copy the Broker. Check the box on the top of the list will select all Brokers in the list.
Edit	Click to set up the remote Broker in the Broker Content Setting page.
Remove	Click to delete the checked Broker(s)
	The page number / total pages of the Broker list. Click < or > to go to the previous or the next page.
Save	Click to save the settings of this page.

Click [Edit] to set up the group in the Broker Content Setting page.

Broker Content Settings	
Broker Name	<input type="text" value="Name"/>
IP / Domain	<input type="text" value="127.0.0.1"/>
Port	<input type="text" value="1883"/>
Client ID	<input type="text" value="e6c7ee7ce93db803"/>
Keep Alive Time(second)	<input type="text" value="60"/>
SSL/TLS	<input checked="" type="checkbox"/> Enabled
Trusted Certificate	<input type="text" value=""/>
Certificate	<input type="text" value=""/>
Private Key	<input type="text" value=""/>
Anonymous Login	<input checked="" type="checkbox"/> Enabled
Test Connection	<input type="button" value="Connection"/>
<input type="button" value="OK"/> <input type="button" value="Cancel"/>	

MQTT Connection > Remote Broker List > Broker Content Settings	
Broker Name	The name of the remote MQTT Broker. User can define a new name.
IP / Domain	Set the IP address or domain name of the Remote MQTT Broker. Default: 127.0.0.1
Port	The remote Broker port. Default: 1883.
Client ID	Set the MQTT Client ID value, default: random value.
Keep Alive Time (second)	Set the time in second that pass away without communication between the UA controller and Cloud platform. Default: 60 second.
SSL/TLS	Check to enable SSL/TLS security communication. Default: Uncheck. Sub-item: Trusted Certificate/Certificate/Private Key. Before enabling, upload the needed file from [File Setting] function menu.
Trusted Certificate	Select the trusted root CA file name uploaded to the controller via the File Setting function to verify the broker side certificate.
Certificate	Select the name of the certificate file uploaded to the controller via the File Setting function as the client side certification. When the "Certificate" field is not empty, the "Private Key" field cannot be empty.
Private Key	Select the name of the Private Key file uploaded to the controller via the File Setting function as the client side Private Key. When the "Private Key" field is not empty, the "Certificate" field cannot be empty.
Anonymous Login	Check to allow anonymous login. Default: Check Enabled.
OK / Cancel	Click: save the setting and exit this page. Cancel: exit without saving.

### 5.3.3 MQTT Group Connection

This function is mainly the MQTT group list of UA series controllers, including adding, removing, setting, and function parameter description.

MQTT groups can combine with the MQTT JSON function of conversion settings to encapsulate device I/O data into JSON format content in groups and then publish or subscribe to a single topic.

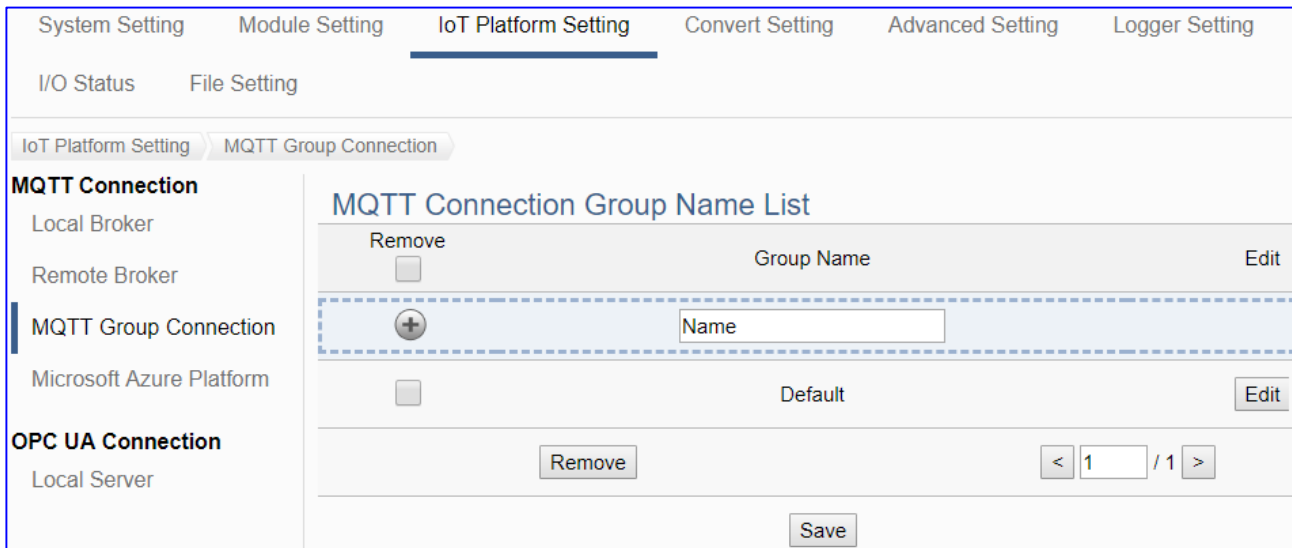

#### Setting Sequence for the MQTT Group Connection:

1. Set up a connection MQTT Broker of Local or Remote Broker.
2. Add and set up a MQTT connection group name in the List.  
Set up the contents of the Topic messages published/subscribed by other external MQTT devices that supporting JSON format for mapping to the Variables Table of the UA controller.
3. Convert the data contents of the MQTT device into JSON format of groups to communicate with other protocols.

For the certificate about the communication security, please refer to [Chapter 7](#).

This section will introduce the function items and setting parameters.

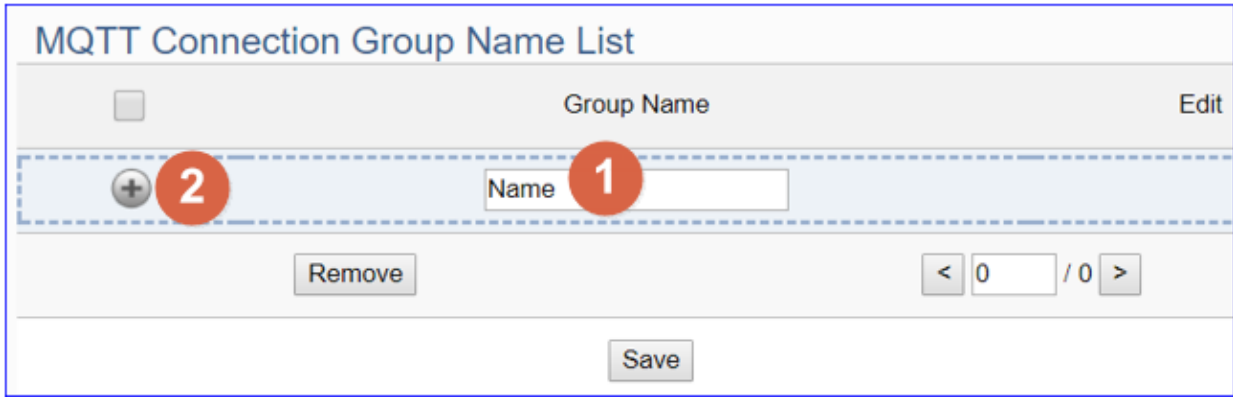

IoT Platform Setting > MQTT Connection > MQTT Connection Group Name List	
Group Name	MQTT connection group name. User can give a new name, e.g. Group1. Default: Name.
	Click to add a list of MQTT connection group.
Save	Click to save the settings of this page.

After adding a list of the MQTT connection group:

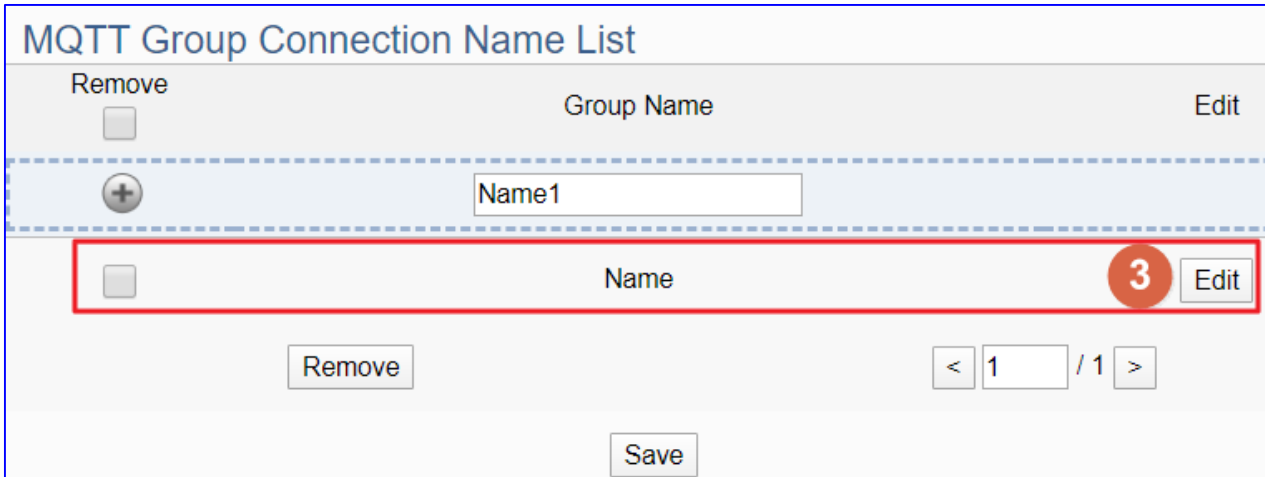

IoT Platform Setting > MQTT Connection > MQTT Connection Group Name List	
Group Name	The MQTT connection group name.
<input type="checkbox"/>	Check the box in the left of the Group name is to select that group, can delete or copy the group. Check the box on the top of the list will select all groups in the list.
Edit	Click to set up the group in the MQTT Client Setting page.
Remove	Click to delete the checked group(s)
	The page number / total pages of the group list. Click < or > to go to the previous or the next page.
Save	Click to save the settings of this page.

Click [Edit] to set up the group in the MQTT Client Setting page.

MQTT Client Setting	
No.	<input type="text" value="2"/>
Group Name	<input type="text" value="test"/>
Scan Rate(ms)	<input type="text" value="1000"/>
Dead Band	<input type="text" value="0"/>
Will Topic	<input type="text"/>
Will	<input type="text"/>
Add Timestamp	<input checked="" type="checkbox"/>
MQTT Connection	<input checked="" type="checkbox"/> Broker (Local)

IoT Platform Setting > MQTT Connection > MQTT Client Setting	
No.	The MQTT Client Number. (Un-editable)
Group Name	The name of the Group. User can define a new name.
Scan Rate(ms)	Set an update frequency for the data. Unit: ms. Default: 1000 ms.
Dead Band	Give a dead bend value for updating a <b>float</b> signal. Default: 0 Dead Band: The minimum amount by which the tag value must change in order for the new tag value to be saved.
Will Topic	The title of a disconnect notice. Default: Null.
Will	The disconnect notice. Default: Null.
Add Timestamp	Add the timestamp in MQTT JSON format message
MQTT Connection	Check the Broker for this MQTT connection, Local Broker or Remote Broker. Remote Broker option will appear only when set in advance.

### Publish & Subscribe

Publish Topic	<input type="text" value="/Name/Publish"/>
Publish QoS	<input style="border-bottom: none; border-right: none; border-top: none; border-left: none; width: 100%;" type="text" value="2"/> ▼
Subscribe Topic	<input type="text" value="/Name/Subscribe"/>
Subscribe QoS	<input style="border-bottom: none; border-right: none; border-top: none; border-left: none; width: 100%;" type="text" value="2"/> ▼
Retain	<input style="border-bottom: none; border-right: none; border-top: none; border-left: none; width: 100%;" type="text" value="No"/> ▼

<b>IoT Platform Setting &gt; MQTT Connection &gt; MQTT Client Setting – Publish &amp; Subscribe</b>	
Publish Topic	The topic of sending/publishing data message.
Publish QoS	The publish QoS (Quality of Service) levels. Default: 2. 0: Delivering a message at most once. 1: Delivering a message at least once. 2: Delivering a message at exactly once.
Subscribe Topic	The topic of receiving/subscribing data message.
Subscribe QoS	The subscribe QoS (Quality of Service) levels. Default: 2. 0: Delivering a message at most once. 1: Delivering a message at least once. 2: Delivering a message at exactly once.
Retain	Whether the Broker to store the message. Default: No.
OK	Click to save the setting and exit this page. Click [Cancel] to exit this page without saving.

### 5.3.4 MQTT Connection - Microsoft Azure Platform

Microsoft Azure Platform is a common platform to integrate IoT devices into the cloud. Many of the applications use MQTT connection to the cloud for the setting is fast and easy. The UA series also provides the MQTT function for module to connect to the Azure platform and allows users to publish messages to Microsoft Azure and receive messages from Microsoft Azure.

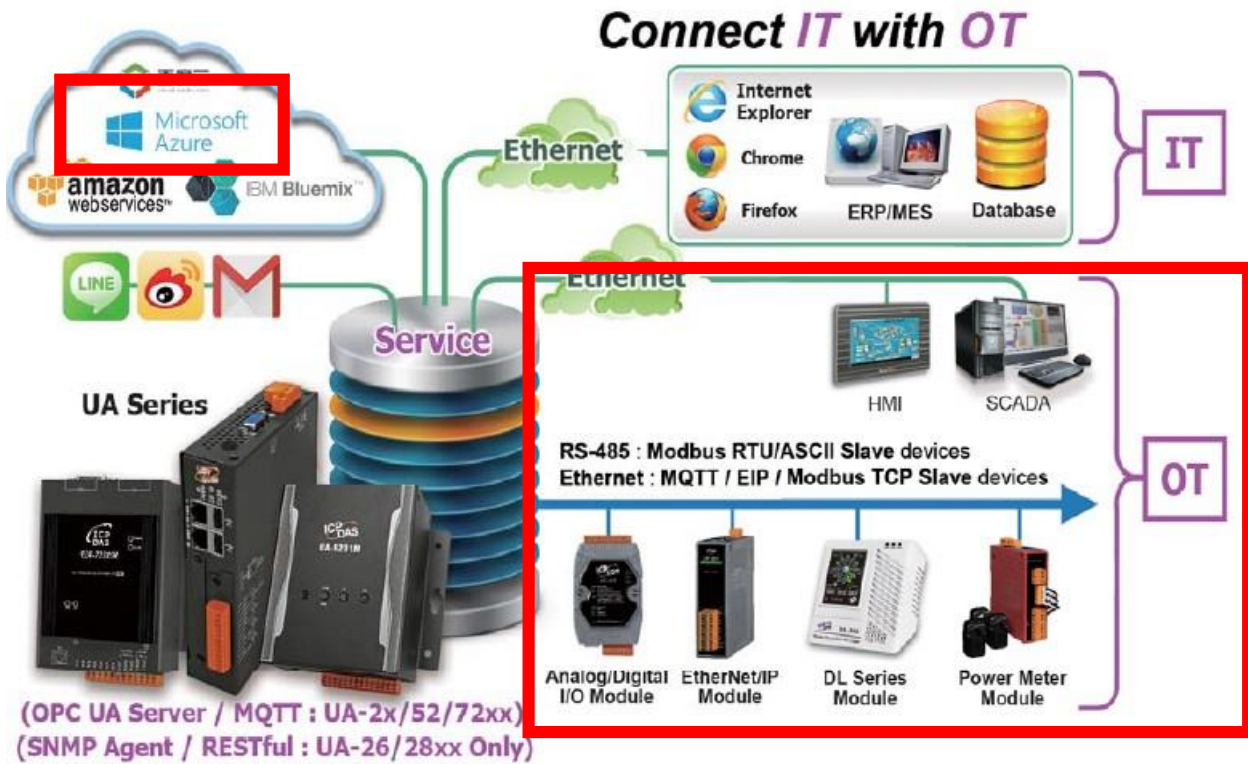

This page will introduce the settings for UA series controller using MQTT service to connect to the Microsoft Azure Platform. It includes new, remove and set up the Azure list and the function parameters

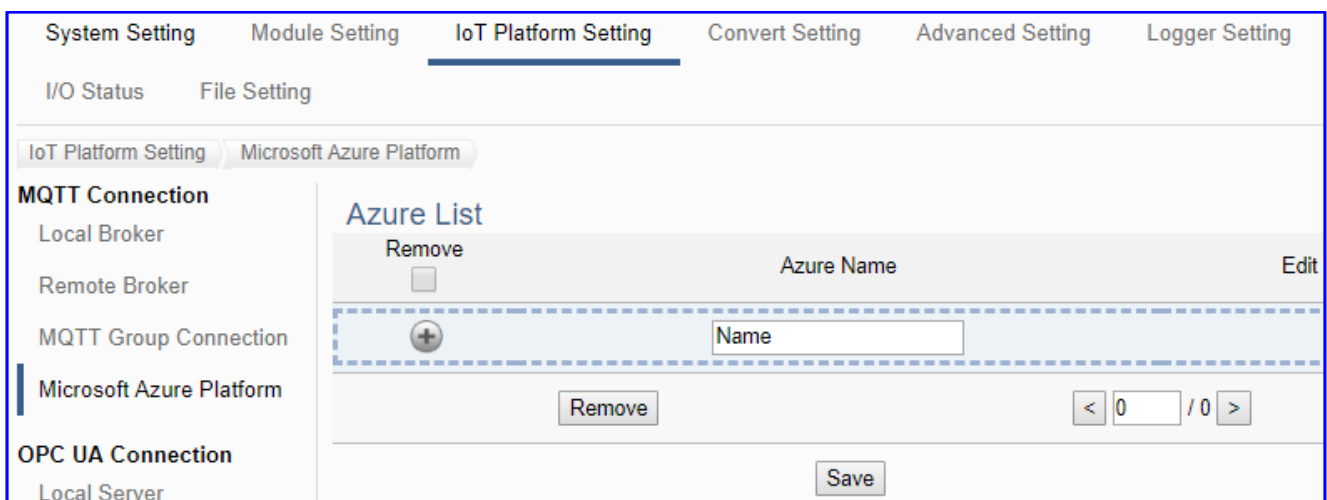

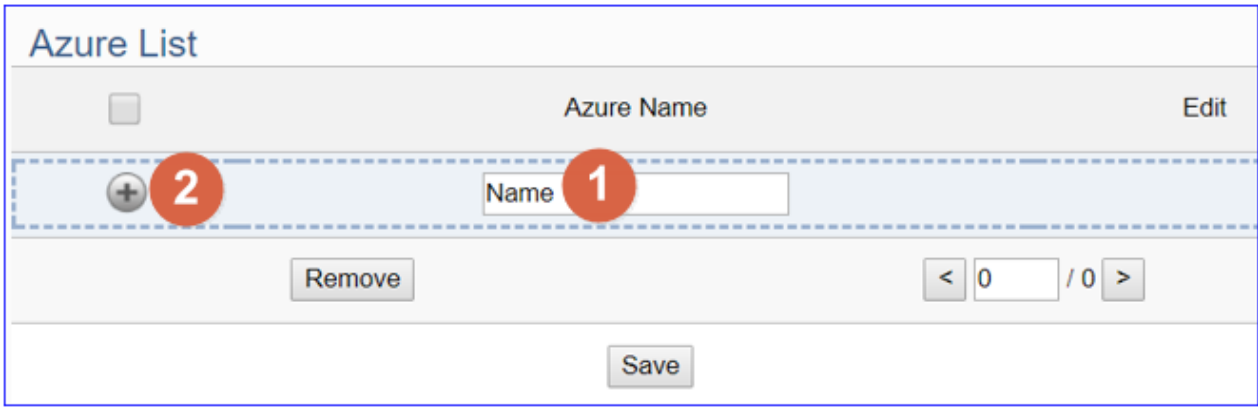

IoT Platform Setting > MQTT Connection > Microsoft Azure Platform > Azure List	
Azure Name	Azure name. User can give a new name1. Default: Name.
	Click to add a list of Azure.

After adding a list of the Azure:

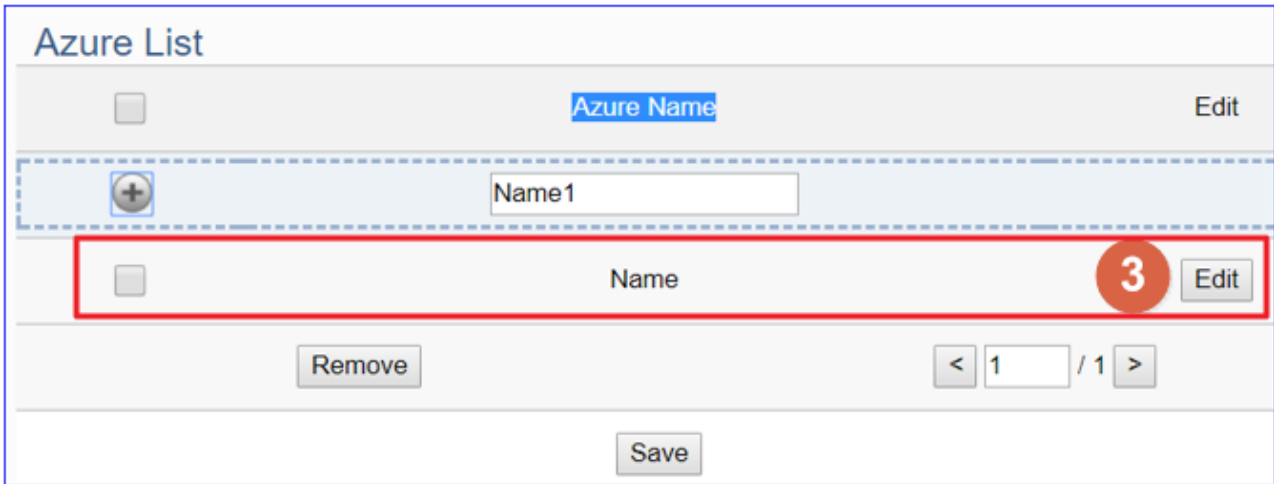

IoT Platform Setting > MQTT Connection > Microsoft Azure Platform > Azure List	
Azure Name	Azure name. User can define the name. Default: Name.
	Click to add a new Azure list.
<input type="checkbox"/>	Check the box in the left of a Azure name is to select that Azure, can delete or copy the Azure. Check the box on the top of the list will select all Azures in the list.
Edit	Click to set up the Azure in the Azure Content Setting page.
Remove	Click to delete the checked Azure(s).
	The page number / total pages of the Azure list. Click < or > to go to the previous or the next page.
Save	Click to save the settings of this page.

Click [Edit] to set up the Azure in the Azure Content Setting page.

### Azure Content Settings

Azure Name	<input type="text" value="Name"/>
SAS Token	<input "="" style="width: 100%;" type="text" value="HostName=;DeviceId=;SharedAccessSignature="/>
Trusted Certificate	<input style="width: 100%;" type="text" value=""/>
Keep Alive Time(second)	<input type="text" value="60"/>
Scan Rate(ms)	<input type="text" value="1000"/>
Dead Band	<input type="text" value="0"/>

IoT Platform Setting > MQTT Connection > Microsoft Azure Platform > Azure Content Settings	
Azure Name	Azure name. User can define the name. Default: Name.
SAS Token	Input the SAS Token which you previously registered for the UA controller from Microsoft Azure. For the procedure to generate a SAS Token, please refer to the “Documentation > Azure IoT Hub > IoT Hub MQTT support” section on the Microsoft Azure Web Site for detailed information.
Trusted Certificate	Select the Trusted Certificate file that you previously got for the UA controller from Microsoft Azure, and uploaded in the menu [MQTT Certificate] of [File Setting] function. Sub-filename: <b>.crt</b>
Keep Alive Time (second)	Set the time in second that pass away without communication between the UA controller and Microsoft Azure. Default: 60 second.
Scan Rate(ms)	Set an update frequency for the task data. Default: 1000 (Unit: ms)
Dead Band	Give a dead bend value for updating a <b>float</b> signal. Default: 0 Dead Band: The minimum amount by which the tag value must change in order for the new tag value to be saved.
OK / Cancel	OK: save and exit this page. Cancel: exit without saving.

### 5.3.5 OPC UA Connection - Local Server

UA series controller built-in OPC UA Server service can integrate the I/O products and the third-party devices, import their data to the back-end SCADA management system or the big-data analysis/decision system, to satisfy the reliability, interoperability and security needs of the Industrial 4.0 automation system.

This setting is for the related service function of OPC UA Server built in UA series controller. The Security policy is **default to enable** the function of **None**, **Basic128Rsa15 (Sign)**, **Basic128Rsa15 (Sign and Encrypt)**, **Basic256 (Sign)**, and **Basic256 (Sign and Encrypt)**.

This page provides the settings for the UA series built-in OPC UA Server.

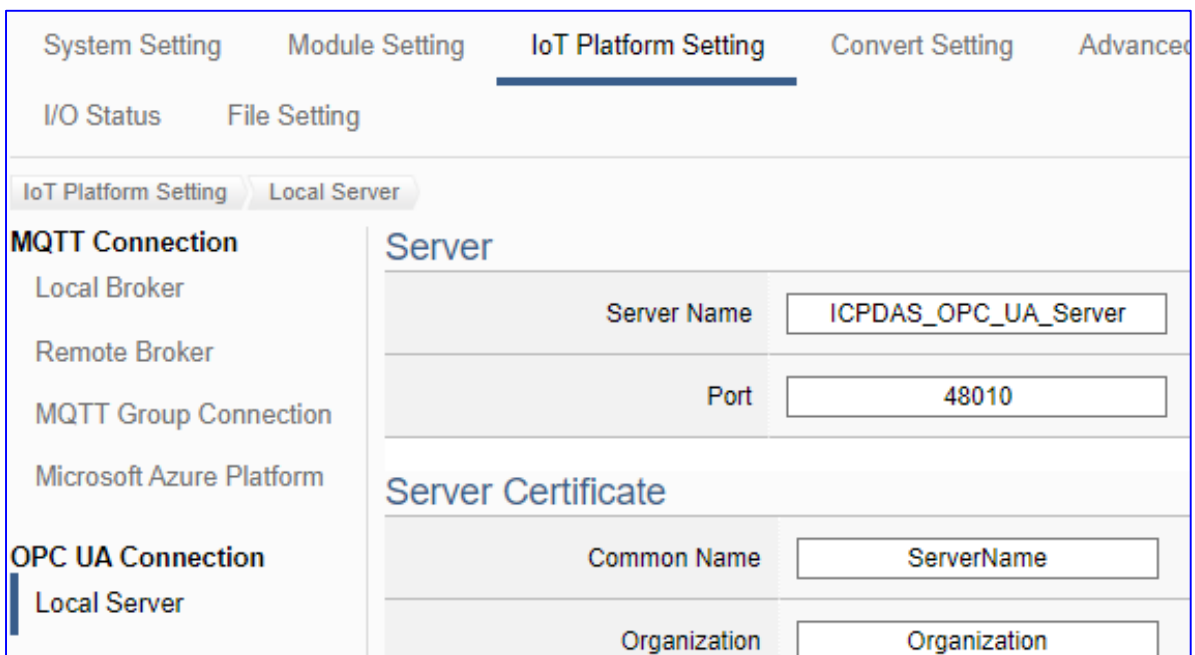

OPC UA Connection > Local Server – Server	
Server Name	Display the active OPC UA Server name. Not editable. System values: ICPDAS_OPC_UA_Server
Port	The communication port number of the OPC UA Server. System Default: 48010.
Save	Click to save the settings of this item.

Server Certificate	
Common Name	<input type="text" value="ServerName"/>
Organization	<input type="text" value="Organization"/>
Organization Unit	<input type="text" value="Unit"/>
Locality	<input type="text" value="LocationName"/>
State	<input type="text" value="State"/>
Country	<input type="text" value="TW"/>
Certificate Validity (Years)	<input type="text" value="20"/>
Key Length	<input type="text" value="1024"/> ▼

OPC UA Connection > Local Server – Server Certificate	
Common Name	Set the content of the self-signed certificate automatically generated by the OPC UA Server
Organization	
Organization Unit	
Locality	
State	
Country	
Certificate Validity (Years)	Set the validity period of the certificate (unit year)
Key Length	Set the length of Key
Save	Click to save the settings of this item.

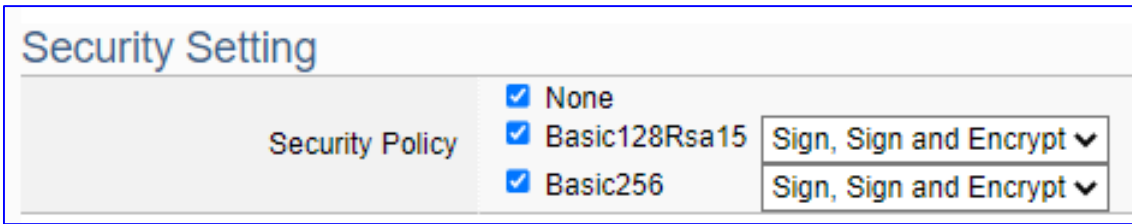

OPC UA Connection > Local Server – Security Setting	
Security Policy	Set the message security mode that the OPC UA Server opens to the Client. 3 Policy: None, Basic128Rsa15, Basic256
None	This policy do not use any security policy.
Basic128Rsa15	This policy has 3 selections: Sign: Message Signing Sign and Encrypt: Message Signing and Encryption Sign; Sign and Encrypt: Message Signing; Message Signing and Encryption
Basic256	This policy has 3 selections: Sign: Message Signing Sign and Encrypt: Message Signing and Encryption Sign; Sign and Encrypt: Message Signing; Message Signing and Encryption
Save	Click to save the settings of this item.

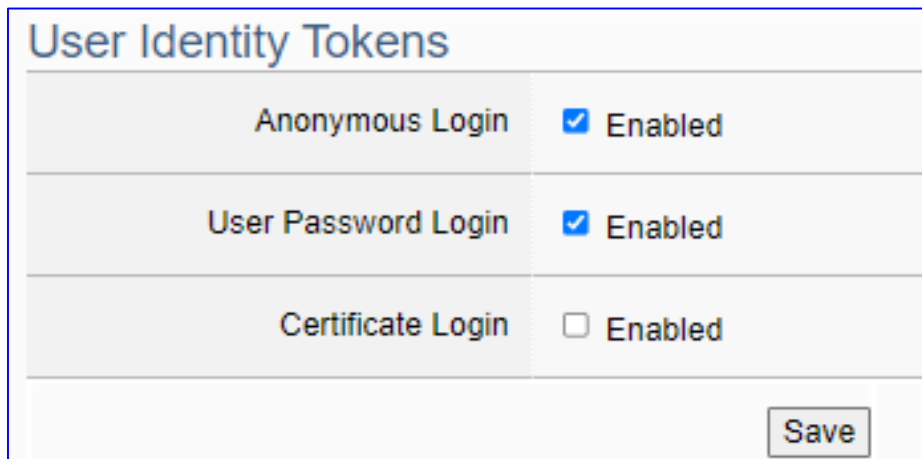

OPC UA Connection > Local Server – User Identity Tokens	
Anonymous Login	Check to enable the anonymous login of clients. Default: check.
User Password Login	Check to enable the user password login of clients. Default: uncheck.
Certificate Login	Check to enable the certificate login of clients. Default: uncheck.
Save	Click to save the settings of this item.

## 5.4 Main Menu: Convert Setting

**Convert Setting** is the 4<sup>th</sup> item of the Main Menu for the communication conversion.

There are 4 converting types: **OPC UA, MQTT, MQTT JSON & MQTT Custom**. Each type has some convert settings items for conversion with the Modbus RTU/TCP/ASCII (Master), MQTT, EtherNet/IP protocols, the OPC UA with XV Module or Internal virtual converting for the data communication, and user custom converting. The function descriptions are on the home page of the Main Menu. This chapter will introduce these function items and setting parameters.

System Setting	Module Setting	IoT Platform Setting	<u>Convert Setting</u>	Advanced Setting	Logger Setting																												
I/O Status	File Setting																																
<div style="border: 1px solid red; padding: 5px;"> <p>Convert Setting</p> <p><b>OPC UA</b></p> <p>Modbus RTU (Master)</p> <p>Modbus TCP (Master)</p> <p>Modbus ASCII (Master)</p> <p>MQTT</p> <p>EtherNet/IP</p> <p>XV Module</p> <p>Internal</p> <p><b>MQTT</b></p> <p>Modbus RTU (Master)</p> <p>Modbus TCP (Master)</p> <p>Modbus ASCII (Master)</p> <p>EtherNet/IP</p> <p><b>MQTT JSON</b></p> <p>Modbus RTU (Master)</p> <p>Modbus TCP (Master)</p> <p>Modbus ASCII (Master)</p> <p><b>MQTT Custom</b></p> <p>IoTCloud</p> </div>																																	
<div style="border: 1px solid blue; padding: 5px;"> <p><b>SNMP</b></p> <p>Modbus RTU (Master)</p> <p>Modbus TCP (Master)</p> </div>																																	
<table border="1" style="width: 100%; border-collapse: collapse;"> <thead> <tr> <th colspan="2">Convert Setting</th> </tr> </thead> <tbody> <tr> <td colspan="2"><b>OPC UA</b></td> </tr> <tr> <td style="text-align: center;">Modbus RTU (Master)</td> <td>Provides OPC UA and Modbus RTU (Master) communication protocol conversion. With this function, the OPC UA Server can read and write the Modbus RTU device that connected to the controller.</td> </tr> <tr> <td style="text-align: center;">Modbus TCP (Master)</td> <td>Provides OPC UA and Modbus TCP (Master) communication protocol conversion. With this function, the OPC UA Server can read and write the Modbus TCP device that connected to the controller.</td> </tr> <tr> <td style="text-align: center;">Modbus ASCII (Master)</td> <td>Provides OPC UA and Modbus ASCII (Master) communication protocol conversion. With this function, the OPC UA Server can read and write the Modbus ASCII device that connected to the controller.</td> </tr> <tr> <td style="text-align: center;">MQTT</td> <td>Provides OPC UA and MQTT communication protocol conversion. With this function, the OPC UA Server can read and write the MQTT device that connected to the controller.</td> </tr> <tr> <td style="text-align: center;">EtherNet/IP</td> <td>Provides OPC UA and ICPDAS EtherNet/IP module communication protocol conversion. With this function, the OPC UA Server can read and write the EIP module that connected to the controller.</td> </tr> <tr> <td style="text-align: center;">XV Module</td> <td>Provides OPC UA and ICPDAS XV module data conversion. With this function, the OPC UA Server can read and write the XV module that on to the controller.</td> </tr> <tr> <td colspan="2"><b>MQTT</b></td> </tr> <tr> <td style="text-align: center;">Modbus RTU (Master)</td> <td>Provides MQTT and Modbus RTU (Master) communication protocol conversion. With this function, users can set the MQTT client to publish the message to the specified broker or subscribe the topic, and so to read and write the single channel of the Modbus RTU device that connected to the controller.</td> </tr> <tr> <td style="text-align: center;">Modbus TCP (Master)</td> <td>Provides MQTT and Modbus TCP (Master) communication protocol conversion. With this function, users can set the MQTT client to publish the message to the specified broker or subscribe the topic, and so to read and write the single channel of the Modbus TCP device that connected to the controller.</td> </tr> <tr> <td colspan="2"><b>SNMP</b></td> </tr> <tr> <td style="text-align: center;">Modbus RTU (Master)</td> <td>Provides SNMP and Modbus RTU (Master) communication protocol conversion. With this function, the SNMP Agent can read and write the Modbus RTU device that connected to the controller.</td> </tr> <tr> <td style="text-align: center;">Modbus TCP (Master)</td> <td>Provides SNMP and Modbus TCP (Master) communication protocol conversion. With this function, the SNMP Agent can read and write the Modbus TCP device that connected to the controller.</td> </tr> </tbody> </table>						Convert Setting		<b>OPC UA</b>		Modbus RTU (Master)	Provides OPC UA and Modbus RTU (Master) communication protocol conversion. With this function, the OPC UA Server can read and write the Modbus RTU device that connected to the controller.	Modbus TCP (Master)	Provides OPC UA and Modbus TCP (Master) communication protocol conversion. With this function, the OPC UA Server can read and write the Modbus TCP device that connected to the controller.	Modbus ASCII (Master)	Provides OPC UA and Modbus ASCII (Master) communication protocol conversion. With this function, the OPC UA Server can read and write the Modbus ASCII device that connected to the controller.	MQTT	Provides OPC UA and MQTT communication protocol conversion. With this function, the OPC UA Server can read and write the MQTT device that connected to the controller.	EtherNet/IP	Provides OPC UA and ICPDAS EtherNet/IP module communication protocol conversion. With this function, the OPC UA Server can read and write the EIP module that connected to the controller.	XV Module	Provides OPC UA and ICPDAS XV module data conversion. With this function, the OPC UA Server can read and write the XV module that on to the controller.	<b>MQTT</b>		Modbus RTU (Master)	Provides MQTT and Modbus RTU (Master) communication protocol conversion. With this function, users can set the MQTT client to publish the message to the specified broker or subscribe the topic, and so to read and write the single channel of the Modbus RTU device that connected to the controller.	Modbus TCP (Master)	Provides MQTT and Modbus TCP (Master) communication protocol conversion. With this function, users can set the MQTT client to publish the message to the specified broker or subscribe the topic, and so to read and write the single channel of the Modbus TCP device that connected to the controller.	<b>SNMP</b>		Modbus RTU (Master)	Provides SNMP and Modbus RTU (Master) communication protocol conversion. With this function, the SNMP Agent can read and write the Modbus RTU device that connected to the controller.	Modbus TCP (Master)	Provides SNMP and Modbus TCP (Master) communication protocol conversion. With this function, the SNMP Agent can read and write the Modbus TCP device that connected to the controller.
Convert Setting																																	
<b>OPC UA</b>																																	
Modbus RTU (Master)	Provides OPC UA and Modbus RTU (Master) communication protocol conversion. With this function, the OPC UA Server can read and write the Modbus RTU device that connected to the controller.																																
Modbus TCP (Master)	Provides OPC UA and Modbus TCP (Master) communication protocol conversion. With this function, the OPC UA Server can read and write the Modbus TCP device that connected to the controller.																																
Modbus ASCII (Master)	Provides OPC UA and Modbus ASCII (Master) communication protocol conversion. With this function, the OPC UA Server can read and write the Modbus ASCII device that connected to the controller.																																
MQTT	Provides OPC UA and MQTT communication protocol conversion. With this function, the OPC UA Server can read and write the MQTT device that connected to the controller.																																
EtherNet/IP	Provides OPC UA and ICPDAS EtherNet/IP module communication protocol conversion. With this function, the OPC UA Server can read and write the EIP module that connected to the controller.																																
XV Module	Provides OPC UA and ICPDAS XV module data conversion. With this function, the OPC UA Server can read and write the XV module that on to the controller.																																
<b>MQTT</b>																																	
Modbus RTU (Master)	Provides MQTT and Modbus RTU (Master) communication protocol conversion. With this function, users can set the MQTT client to publish the message to the specified broker or subscribe the topic, and so to read and write the single channel of the Modbus RTU device that connected to the controller.																																
Modbus TCP (Master)	Provides MQTT and Modbus TCP (Master) communication protocol conversion. With this function, users can set the MQTT client to publish the message to the specified broker or subscribe the topic, and so to read and write the single channel of the Modbus TCP device that connected to the controller.																																
<b>SNMP</b>																																	
Modbus RTU (Master)	Provides SNMP and Modbus RTU (Master) communication protocol conversion. With this function, the SNMP Agent can read and write the Modbus RTU device that connected to the controller.																																
Modbus TCP (Master)	Provides SNMP and Modbus TCP (Master) communication protocol conversion. With this function, the SNMP Agent can read and write the Modbus TCP device that connected to the controller.																																

The settings of Modbus RTU/ASCII are the same. Here will introduce them together.

<p><b>OPC UA</b></p>	<p>Use <b>OPC UA Service</b> to convert with <b>Modbus RTU/ASCII</b> protocol. (5.4.1)                  Use <b>OPC UA Service</b> to convert with <b>Modbus TCP</b> protocol. (5.4.2)                  Use <b>OPC UA Service</b> to convert with <b>MQTT</b> protocol. (5.4.3)                  Use <b>OPC UA Service</b> to convert with <b>EtherNet/IP</b> protocol. (5.4.4)                  Use <b>OPC UA Service</b> to convert with <b>XV Module</b> communication. (5.4.5)                  Use <b>OPC UA Service</b> to convert with <b>Internal</b> communication. (5.4.6)</p>
<p><b>MQTT</b></p>	<p>Use <b>MQTT Service</b> to convert with <b>Modbus RTU/ASCII</b> protocol. (5.4.7)                  Use <b>MQTT Service</b> to convert with <b>Modbus TCP</b> protocol. (5.4.8)                  Use <b>MQTT Service</b> to convert with <b>EtherNet/IP</b> protocol. (5.4.9)</p>
<p><b>MQTT JSON</b></p>	<p>Use <b>MQTT Service</b> in group of JSON format to convert with <b>Modbus RTU/ASCII</b> protocol. (5.4.10)                  Use <b>MQTT Service</b> in group of JSON format to convert with <b>Modbus TCP</b> protocol. (5.4.11)</p>
<p><b>MQTT Custom</b></p>	<p><b>IoTCloud</b>: Users can customize the MQTT format layout and add the module value to the publishing message. With <b>customized MQTT message content</b>, this function can support multiple IoT platforms. (5.4.12)</p>
<p><b>SNMP</b></p>	<p>Use <b>SNMP Agent Service</b> to convert with <b>Modbus RTU</b> protocol. (5.4.13)                  Use <b>SNMP Agent Service</b> to convert with <b>Modbus TCP</b> protocol. (5.4.14)</p>

**UA Series Function Diagram:**

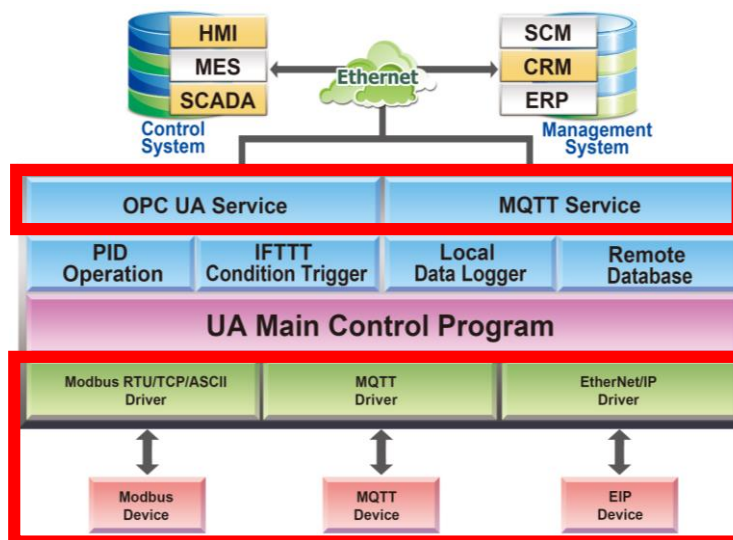

### 5.4.1 OPC UA and Modbus RTU/ASCII Conversion

This page provides OPC UA and Modbus RTU/ASCII (Master) communication protocol conversion. With this function, the OPC UA Server can read and write the Modbus RTU / ASCII device that connected to the controller.

The settings of Modbus RTU/ASCII are the same. Here will introduce them together.

#### Function Diagram:

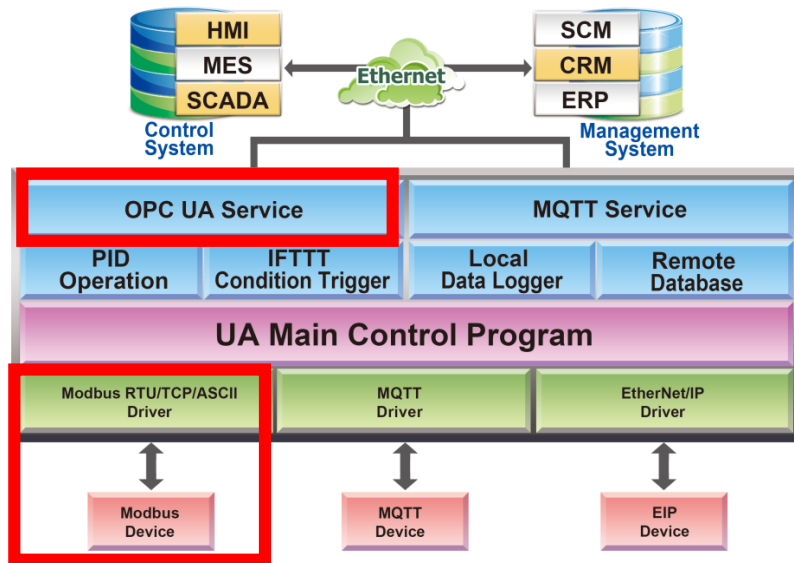

#### Application Solution:

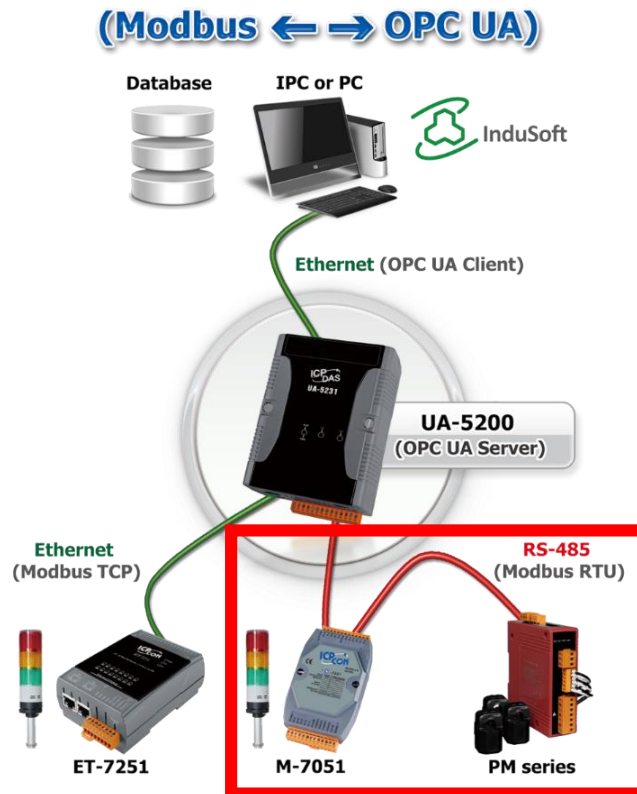

When entering the menu [**Convert Setting**] and the sub-menu [OPC UA] > Modbus RTU (Master) or Modbus ASCII (Master), the Modbus RTU/ASCII modules preset in the [Module Setting] will show up in the Module List. (Refer to [Chapter 5.2](#) for the Module Setting.)

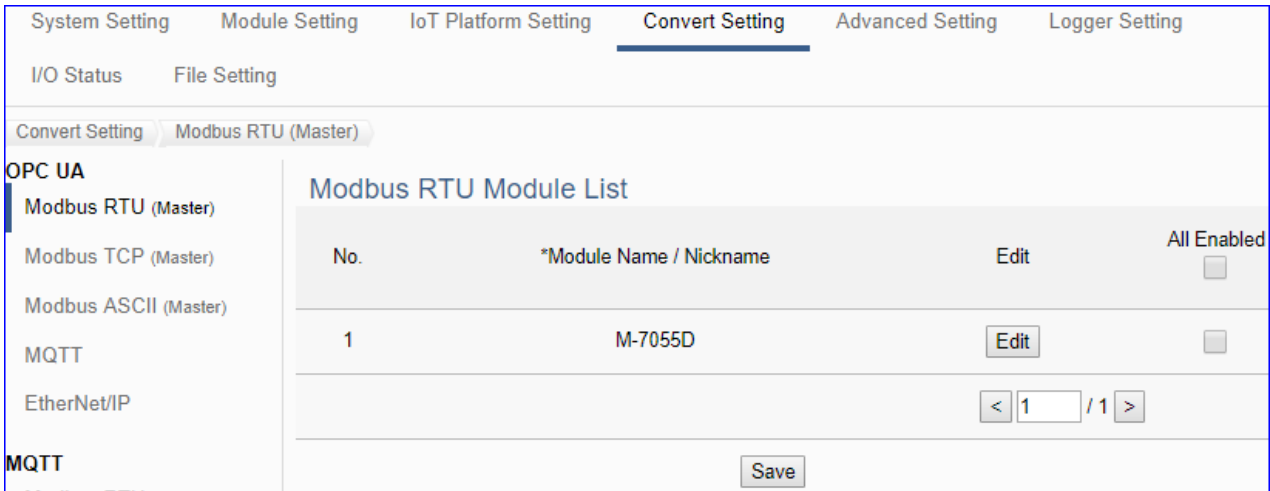

Convert Setting > OPC UA > Modbus RTU (Master) Module List	
No.	The module number in the module list (Not editable here)
*Module Name / Nickname	The module name set in the module list (Not editable here)
All Enabled <input type="checkbox"/> Enable <input type="checkbox"/>	Check [All Enabled] box to enable all modules in list for conversion. Default: Uncheck. Check the box of each module can enable just that module for conversion.
Edit	If user wants to enable some I/O channels for conversion, click [Edit] of that module to enter the “Variable Tale” setting. It is normal to set all channels as enabled, and the conversion will not affect the unconnected channels.
<input type="button" value="&lt;"/> <input type="text" value="1"/> / 1 <input type="button" value="&gt;"/>	The page number of the module list: Current page / Total pages. Click < or > to go to the previous or next page.
Save	Click to save the settings of this page.

This function is to enable the communication conversion module, please  check the box of the converting module. If user wants to enable some I/O of the module, please click [Edit] button to enter the “Module Content Setting” page.

The “Module Content Setting” page after clicking the [Edit] button:

**Module Content Setting**

No.

Module Name

**Variable Table**

Name	Attribute	Data Type	Enabled
Tag0	<input type="text" value="Read"/>	Float	<input type="checkbox"/>
Tag0	<input type="text" value="Read / Write"/>	Short	<input checked="" type="checkbox"/>
Tag0	<input type="text" value="Read"/>	Bool	<input checked="" type="checkbox"/>
Tag1	<input type="text" value="Read"/>	Bool	<input type="checkbox"/>
Tag0	<input type="text" value="Read / Write"/>	Bool	<input checked="" type="checkbox"/>
Tag1	<input type="text" value="Read / Write"/>	Bool	<input type="checkbox"/>

<b>Convert Setting &gt; OPC UA &gt; Modbus RTU (Master) – Module Content Setting</b>	
No.	The module number in the module list (Not editable here)
Module Name	The module name set in the module list (Not editable here)
<b>Convert Setting &gt; OPC UA &gt; Modbus RTU (Master) – Variable Table</b>	
Name	Display the variable name that set in the Modbus Address Mapping Table page (Not editable here)
Attribute	Display data attribute of the variable. (Not editable) Include: Read, Read/Write...
Data Type	Display data type of the variable that set in the Modbus Address Mapping Table page. (Not editable) Include: Bool, Short, Float...
Enabled	Check [Enabled] box of the top row can enable all variables in list. Check the box of each variable can enable just that variable for conversion. Default: Uncheck.
OK	Click to save this page settings and back to the module list page.

When complete the setting, click [OK] to save this page settings and back to the module list page. Remember to click [Save] to save the Convert Setting.

### 5.4.2 OPC UA and Modbus TCP Conversion

This page provides OPC UA and Modbus TCP (Master) communication protocol conversion. With this function, the OPC UA Server can read and write the Modbus TCP device that connected to the controller.

**Function Diagram:**

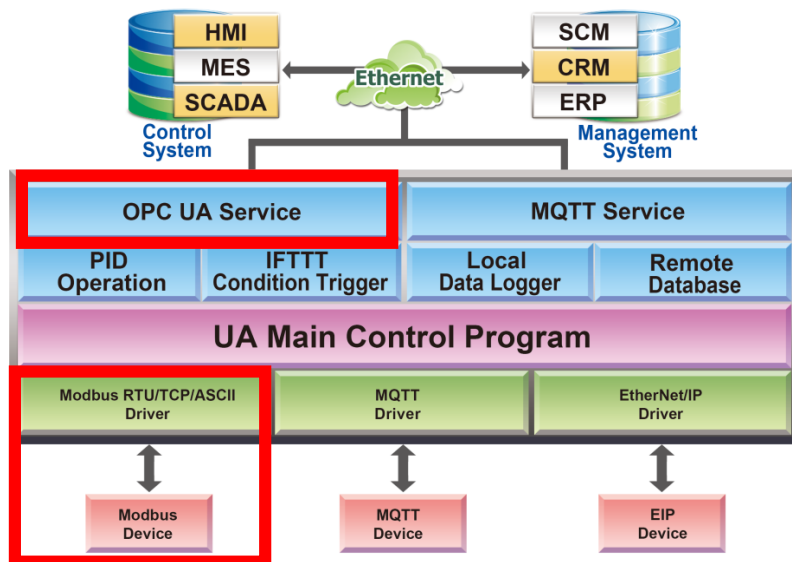

**Application Solution:**



When entering the menu [Convert Setting] and the sub-menu [OPC UA] > Modbus TCP (Master), the Modbus TCP modules preset in the [Module Setting] will show up in the Module List. (Refer to [Chapter 5.2](#) for the Module Setting.)

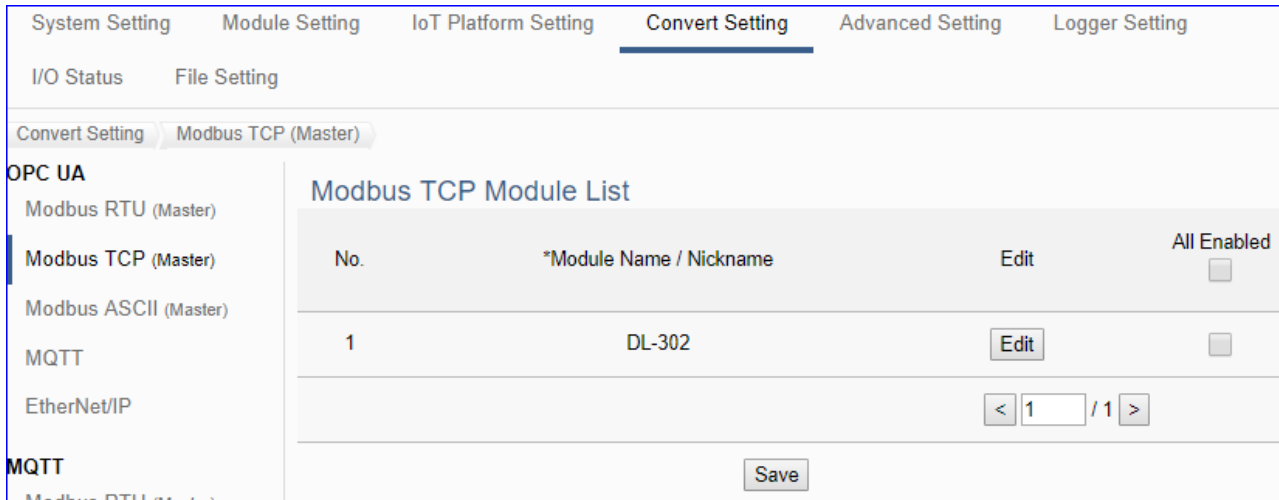

Convert Setting > OPC UA > Modbus TCP (Master) Module List	
No.	The module number in the module list (Not editable here)
*Module Name / Nickname	The module name set in the module list (Not editable here)
All Enabled <input type="checkbox"/> <input type="checkbox"/> Enable	Check [All Enabled] box to enable all modules in list for conversion. Default: Uncheck. Check the box of each module can enable just that module for conversion.
Edit	Click to enter the “Module Content Setting” page to set up and enable the I/O.
<input type="button" value="1"/> / 1	The page number of the module list: Current page / Total pages. Click < or > to go to the previous or next page.
Save	Click to save the settings of this page.

This function is to enable the communication conversion module, please  check the box of the converting module. If user wants to enable some I/O of the module, please click [Edit] button to enter the “Module Content Setting” page.

The “Module Content Setting” page after clicking the [Edit] button:

Module Content Setting			
No.	<input type="text" value="1"/>		
Module Name	<input type="text" value="Example1"/>		
Variable Table			
Name	Attribute	Data Type	Enabled <input checked="" type="checkbox"/>
Tag0	<input type="text" value="Read"/>	Short	<input checked="" type="checkbox"/>
Tag0	<input type="text" value="Read / Write"/>	Short	<input checked="" type="checkbox"/>
Tag0	<input type="text" value="Read"/>	Bool	<input checked="" type="checkbox"/>
Tag0	<input type="text" value="Read / Write"/>	Bool	<input checked="" type="checkbox"/>
Tag1	<input type="text" value="Read / Write"/>	Bool	<input checked="" type="checkbox"/>
<input type="button" value="OK"/>		<input type="button" value="Cancel"/>	

Convert Setting > OPC UA > Modbus TCP (Master) – Module Content Setting	
No.	The module number in the module list (Not editable here)
Module Name	The module name set in the module list (Not editable here)
Convert Setting > OPC UA > Modbus TCP (Master) – Variable Table	
Name	Display the variable name that set in the Modbus Address Mapping Table page (Not editable here)
Attribute	Display data attribute of the variable. (Not editable) Include: Read, Read/Write...
Data Type	Display data type of the variable that set in the Modbus Address Mapping Table page. (Not editable) Include: Bool, Short, Float...
Enabled	Check [Enabled] box of the top row can enable all variables in list. Check the box of each variable can enable just that variable for conversion. Default: Uncheck.
OK	Click to save this page settings and back to the module list page.

When complete the setting, click [OK] to save this page settings and back to the module list page. And remember to click [Save] to save the Convert Setting.

### 5.4.3 OPC UA and MQTT Conversion

This page provides OPC UA and MQTT communication protocol conversion. With this function, the OPC UA Server can read and write the MQTT device that connected to the controller.

#### Function Diagram:

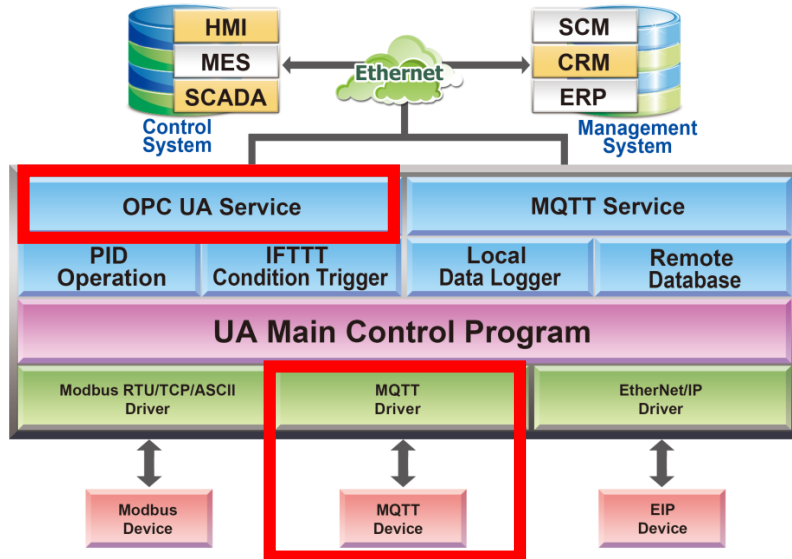

#### Application Solution:



When entering the menu [Convert Setting] and the sub-menu [OPC UA] > MQTT, the MQTT modules preset in the [Module Setting] will show up in the Module List. (Refer to [Chapter 5.2](#) for the Module Setting.)

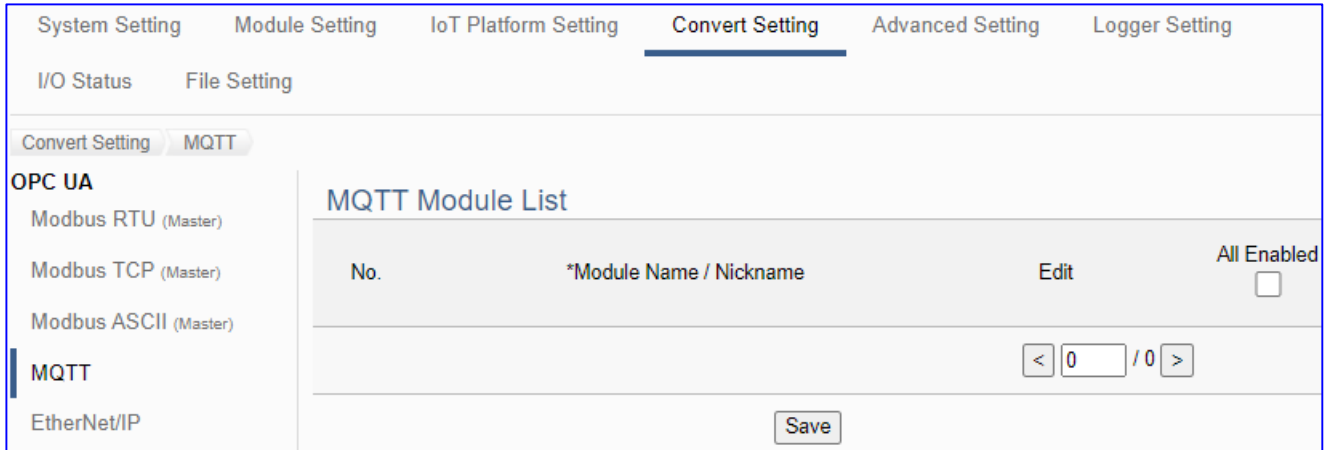

Convert Setting > OPC UA > MQTT - MQTT Module List	
No.	The module number in the module list (Not editable here)
*Module Name / Nickname	The module name set in the module list (Not editable here)
All Enabled <input type="checkbox"/> <input type="checkbox"/> Enable	Check [All Enabled] box to enable all modules in list for conversion. Default: Uncheck. Check the box of each module can enable just that module for conversion.
Edit	Click to enter the “MQTT Client Setting” page to enable the I/O.
<input style="display: inline-block; width: 20px; height: 20px; border: 1px solid gray;" type="button" value=" &lt; 1 "/> / 1 <input style="display: inline-block; width: 20px; height: 20px; border: 1px solid gray;" type="button" value=" &gt; "/>	The page number of the module list: Current page / Total pages. Click < or > to go to the previous or next page.
Save	Click to save the settings of this page.

This function is to enable the communication conversion module, please check the box of the converting module. If user wants to enable some I/O of the module, please click [Edit] button to enter the “Module Content Setting” page.

[Module Content Setting] page:

**Module Content Setting**

No.

---

Module Name

---

**Variable Table**

Name	Attribute	Data Type	Enabled
Temperature	<input type="text" value="Read"/>	Float	<input checked="" type="checkbox"/>
Humidity	<input type="text" value="Read"/>	Float	<input checked="" type="checkbox"/>
CO2	<input type="text" value="Read"/>	Short	<input checked="" type="checkbox"/>

<b>Convert Setting &gt; OPC UA &gt; MQTT - MQTT Module List &gt; Module Content Setting</b>	
No.	The module number in the module list (Not editable here)
Module Name	Give a name, e.g. model number or name. Default: Name.
<b>Convert Setting &gt; OPC UA &gt; MQTT - MQTT Module List &gt; Variable Table</b>	
No.	The module name in the module list (Not editable here)
Attribute	Display data attribute of the variable. (Not editable) Include: Read, Read/Write...
Data Type	Display data type of the MQTT variable. Include: Bool, Short, Unsigned Short, Long, Unsigned Long, Float, Double, String.
Enabled	Check [Enabled] box of the top row can enable all variables in list. Check the box of each variable can enable just that variable for conversion. Default: Uncheck.
OK / Cancer	Click [OK] to save and exit the page settings. Click [Cancer] to exit without saving.

### 5.4.4 OPC UA and EtherNet/IP Conversion

This page provides OPC UA and EtherNet/IP communication protocol conversion. With this function, the OPC UA Server can read and write the EtherNet/IP EIP-2000 device that connected to the controller.

**Function Diagram:**

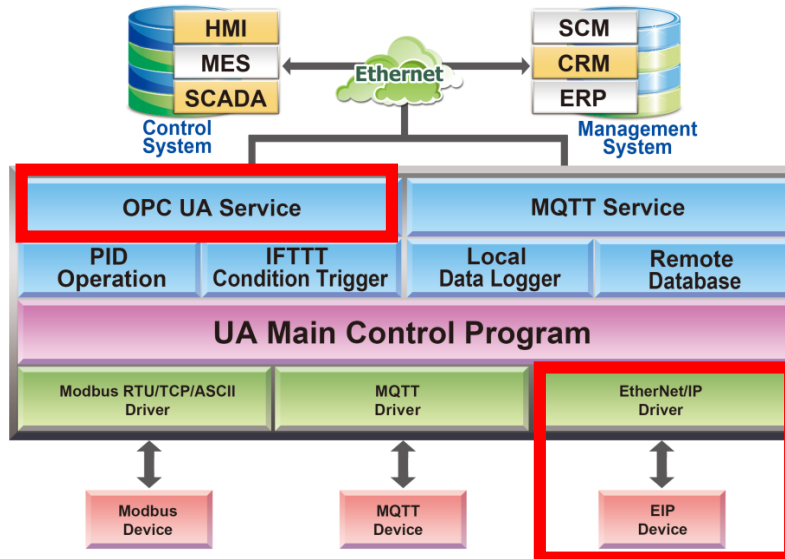

**Application Solution:**

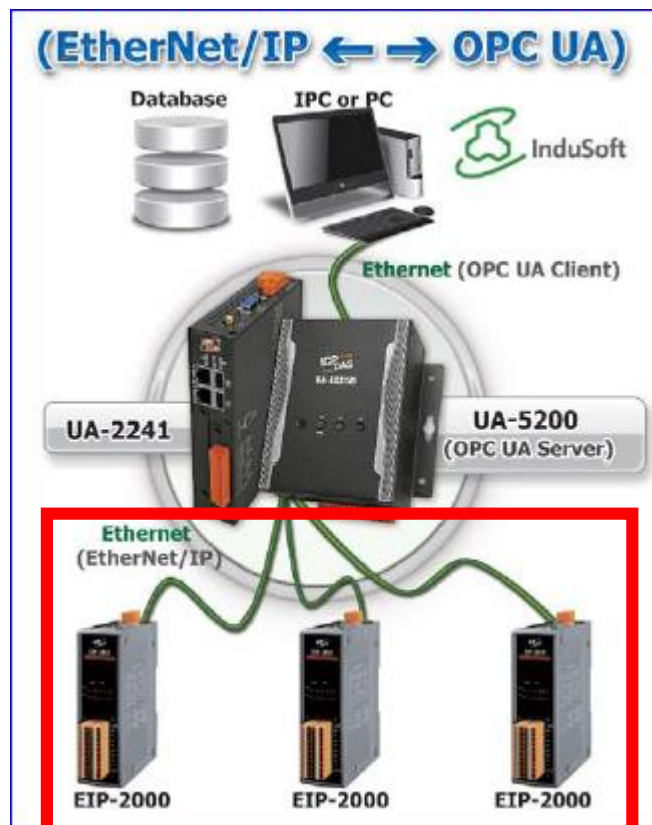

When entering the menu [Convert Setting] and the sub-menu [OPC UA] > EtherNet/IP, the EIP-2000 modules preset in the [Module Setting] will show up in the Module List. (Refer to [Chapter 5.2](#) for the Module Setting.)

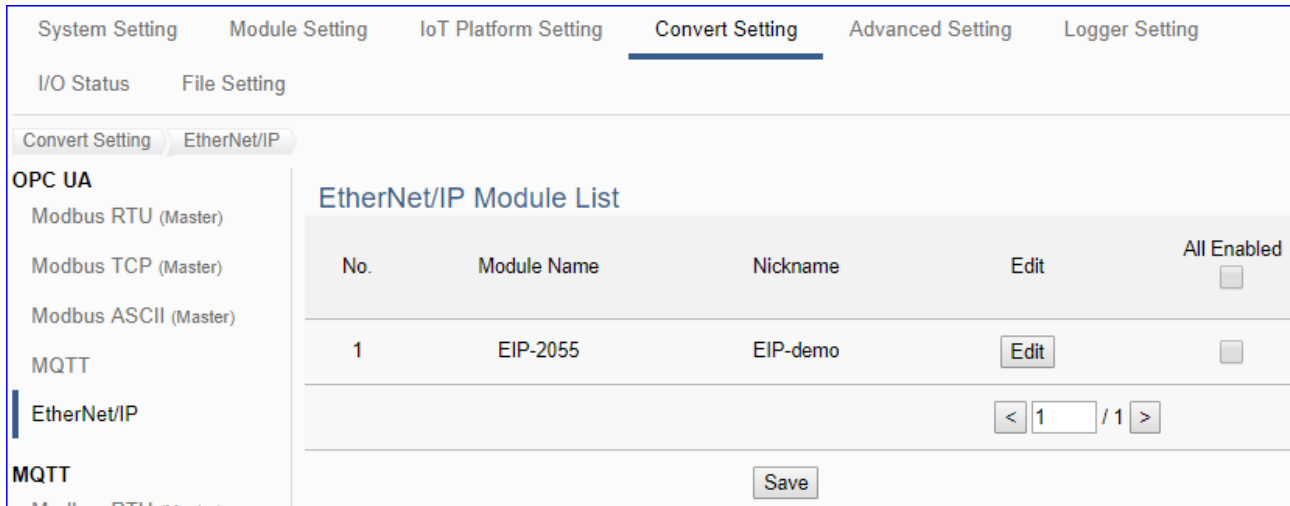

Convert Setting > OPC UA > EtherNet/IP Module List	
No.	The module number in the module list (Not editable here)
Module Name	The module name selected in the module list (Not editable here)
Nickname	The user defined name for the module (Not editable here)
All Enabled <input type="checkbox"/> <input type="checkbox"/> Enable	Check [All Enabled] box to enable all modules in list for conversion. Default: Uncheck. Check the box of each module can enable just that module for conversion.
Edit	Click to enter the “Module Content Setting” page to set up and enable the I/O.
<input type="button" value="&lt;"/> 1 / 1 <input type="button" value="&gt;"/>	The page number of the module list: Current page / Total pages. Click < or > to go to the previous or next page.
Save	Click to save the settings of this page.

This function is to enable the communication conversion module, please  check the box of the converting module. If user wants to enable some I/O of the module, please click [Edit] button to enter the “Module Content Setting” page.

The “Module Content Setting” page after clicking the [Edit] button:

Module Content Setting			
No.	<input type="text" value="1"/>		
Module Name	<input type="text" value="EIP-2055"/>		
NickName	<input type="text" value="EIP-demo"/>		
Variable Table			
Name	Attribute	Data Type	Enabled <input type="checkbox"/>
DI0	<input type="text" value="Read"/>	Bool	<input type="checkbox"/>
DI1	<input type="text" value="Read"/>	Bool	<input type="checkbox"/>
DO6	<input type="text" value="Read / Write"/>	Bool	<input type="checkbox"/>
DO7	<input type="text" value="Read / Write"/>	Bool	<input type="checkbox"/>
		<input type="button" value="OK"/>	<input type="button" value="Cancel"/>

Convert Setting > OPC UA > EtherNet/IP – Module Content Setting	
No.	The module number in the module list (Not editable here)
Module Name	The module name set in the module list (Not editable here)
Convert Setting > OPC UA > EtherNet/IP – Variable Table	
Name	Display the variable name that set in the Modbus Address Mapping Table page (Not editable here)
Attribute	Display data attribute of the variable. (Not editable) Include: Read, Read/Write...
Data Type	Display data type of the variable that set in the Modbus Address Mapping Table page. (Not editable) Include: Bool, Short, Float...
Enabled	Check [Enabled] box of the top row can enable all variables in list. Check the box of each variable can enable just that variable for conversion. Default: Uncheck.
OK	Click to save this page settings and back to the module list page.

When complete the setting, click [OK] to save this page settings and back to the module list page. Remember to click [Save] to save the Convert Setting.

### 5.4.5 OPC UA and XV Module Conversion

This page provides OPC UA and ICP DAS XV module data conversion. With this function, the OPC UA Server can read and write the XV module on the controller.

UA-2800 series supplies one XV expansion board slot. Users can purchase 1 **XV511i** module to expand 4 RS-485 ports, or, buy one of the **XV107/110/111/116/119/303/306/307/310** modules to expand the I/O channels.

When entering the menu [Convert Setting] and the sub-menu [OPC UA] > XV Module, the XV module preset in the [Module Setting] will show up in the Module List. (Refer to [Chapter 5.2](#) for the Module Setting.)

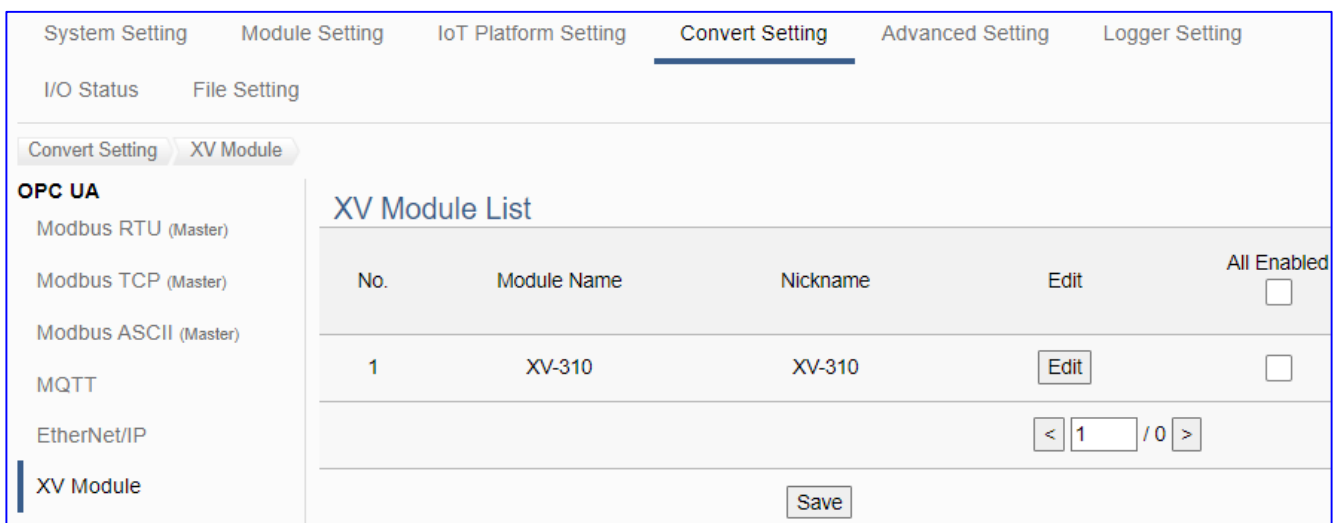

Convert Setting > OPC UA > XV Module > XV Module List	
No.	The module number in the module list (Not editable here)
Module Name	The module name selected in the module list (Not editable here)
Nickname	The user defined name for the module (Not editable here)
Edit	Click to enter the “Module Content Setting” page to set up and enable the I/O.
All Enabled <input type="checkbox"/> Enable <input type="checkbox"/>	Check [All Enabled] box to enable all modules in list for conversion. Check the box of each module can enable just that module for conversion. Default: Uncheck.
<input type="button" value=" &lt; 1 / 1 &gt;"/>	The page number of the module list: Current page / Total pages. Click < or > to go to the previous or next page.
Save	Click to save the settings of this page.

This function is to enable the communication conversion module, please  check the box of the converting module. If user wants to enable some I/O of the module, please click [Edit] button to enter the “Module Content Setting” page.

The “Module Content Setting” page after clicking the [Edit] button:

Module Content Setting			
No.	<input type="text" value="1"/>		
Module Name	<input type="text" value="XV-310"/>		
NickName	<input type="text" value="XV-310"/>		
Variable Table			
Name	Attribute	Data Type	Enabled <input type="checkbox"/>
AI0	<input type="text" value="Read"/> ▼	Float	<input type="checkbox"/>
AI1	<input type="text" value="Read"/> ▼	Float	<input type="checkbox"/>

DO2	<input type="text" value="Read / Write"/> ▼	Bool	<input type="checkbox"/>
DO3	<input type="text" value="Read / Write"/> ▼	Bool	<input type="checkbox"/>
<input type="button" value="OK"/> <input type="button" value="Cancel"/>			

Convert Setting > OPC UA > EtherNet/IP – Module Content Setting	
No.	The module number in the module list (Not editable here)
Module Name	The module name set in the module list (Not editable here)
Nickname	The user defined name for the module (Not editable here)
Convert Setting > OPC UA > EtherNet/IP – Variable Table	
Name	Display the variable name that set in the Modbus Address Mapping Table page (Not editable here)
Attribute	Display data attribute of the variable. (Not editable) Include: Read, Read/Write...
Data Type	Display data type of the variable that set in the Modbus Address Mapping Table page. (Not editable) Include: Bool, Short, Float...
Enabled	Check [Enabled] box of the top row can enable all variables in list. Check the box of each variable can enable just that variable for conversion. Default: Uncheck.
OK / Cancer	Click [OK] to save and exit the page settings. Click [Cancer] to exit without saving.

When complete the setting, click [OK] to save this page settings and back to the module list page. Remember to click [Save] to save the Convert Setting.

### 5.4.6 OPC UA and Internal Conversion

The Internal function can create internal modules and variables for virtual reading and writing, or as an intermediary to provide data exchange for the communication of OPC UA Clients.

- \* Internal Variable: max. 8 internal modules; max. 100 internal variables (tags) per module.
- \* Protocol Communication Conversion: provide Internal to OPC UA Server conversion.

#### Application Solution:



When entering the menu [Convert Setting] and the sub-menu [OPC UA] > Internal, the internal modules preset in the [Module Setting] will show up in the Module List. (Refer to Chapter 5.2 for the Module Setting.)

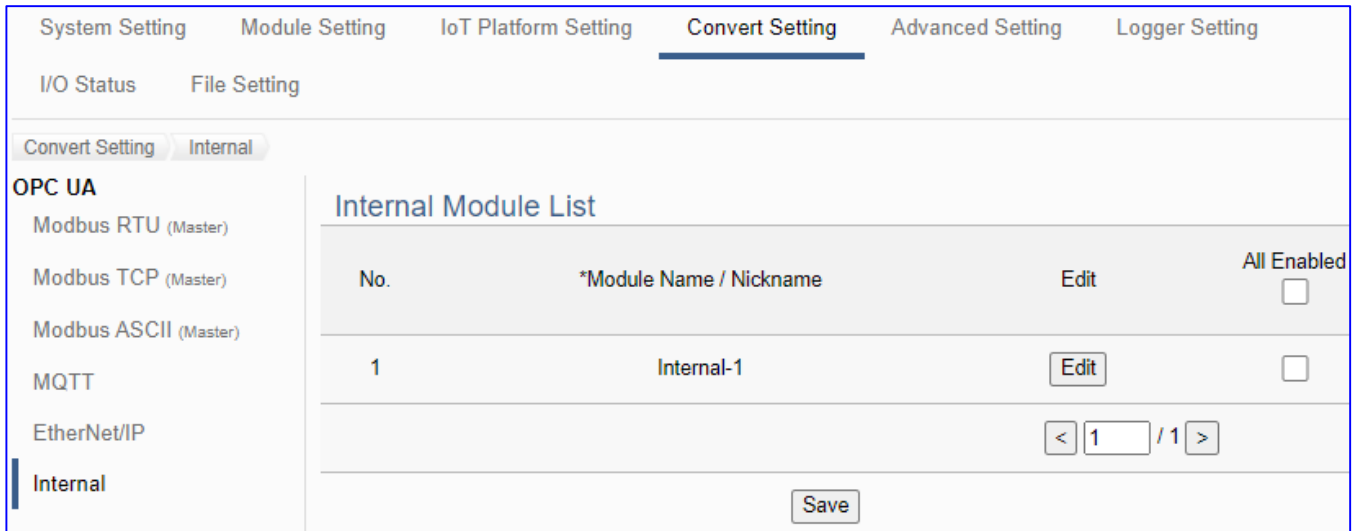

Convert Setting > OPC UA > Internal - Internal Module List	
No.	The module number in the module list (Not editable here)
Module Name / Nickname	The module name set in the module list (Not editable here)
Edit	Click to enter the “Internal Client Setting” page to enable the I/O.
All Enabled <input type="checkbox"/> <input type="checkbox"/> Enable	Check [All Enabled] box to enable all modules in list for conversion. Default: Uncheck. Check the box of each module can enable just that module for conversion.
<input type="button" value="&lt;"/> <input type="text" value="1"/> / 1 <input type="button" value="&gt;"/>	The page number of the module list: Current page / Total pages. Click < or > to go to the previous or next page.
Save	Click to save the settings of this page.

This function is to enable the communication conversion module, please  check the box of the converting module. If user wants to enable some I/O of the module, please click [Edit] button to enter the “Module Content Setting” page.

[Module Content Setting] page:

Module Content Setting			
No.	<input type="text" value="1"/>		
Module Name	<input type="text" value="Internal-1"/>		
Variable Table			
Variable Name	Attribute	Data Type	Enabled <input type="checkbox"/>
Tag2	<input type="text" value="Read / Write"/>	String	<input type="checkbox"/>
Tag3	<input type="text" value="Read / Write"/>	String	<input type="checkbox"/>
Tag0	<input type="text" value="Read / Write"/>	Bool	<input type="checkbox"/>
Tag1	<input type="text" value="Read / Write"/>	Bool	<input type="checkbox"/>
<input type="button" value="OK"/>		<input type="button" value="Cancel"/>	

Convert Setting > OPC UA > Internal - Internal Module List > Module Content Setting	
No.	The module number in the module list (Not editable here)
Module Name	Give a name, e.g. model number or name. Default: Name.
Convert Setting > OPC UA > Internal - Internal Module List > Variable Table	
Variable Name	The Variable name in the module list (Not editable here)
Attribute	Display data attribute of the variable. (Not editable) Include: Read, Read/Write...
Data Type	Display data type of the Internal variable. Include: Bool, Short, Unsigned Short, Long, Unsigned Long, Float, Double, String. (Not editable here)
Enabled	Check [Enabled] box of the top row can enable all variables in list. Check the box of each variable can enable just that variable for conversion. Default: Uncheck.
OK / Cancer	Click [OK] to save and exit the page settings. Click [Cancer] to exit without saving.

### 5.4.7 MQTT and Modbus RTU/ASCII Conversion

This page provides MQTT and Modbus RTU/ASCII (Master) communication protocol conversion. With the MQTT Service function, users can set the MQTT client to publish the message to the specified broker or subscribe the topic, and so to read and write the single channel of the Modbus device that connected to the controller.

The settings of Modbus RTU/ASCII are the same. Here will introduce them together. For the certificate about the communication security, please refer to [Chapter 7](#).

#### Function Diagram:

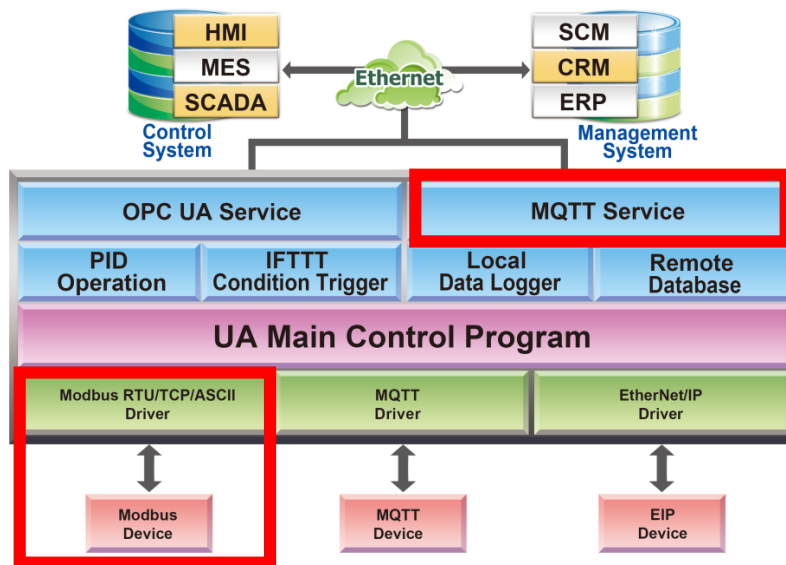

#### Application Solution:

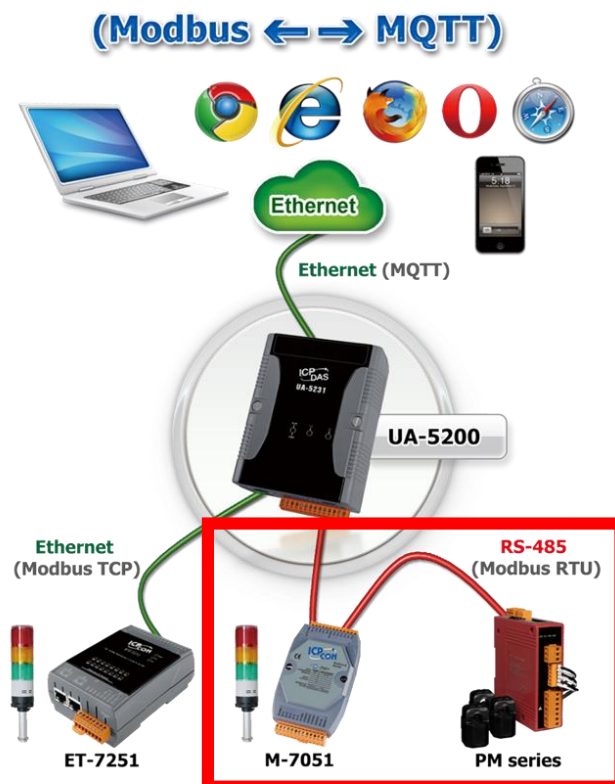

When entering the menu [Convert Setting] and the sub-menu [MQTT] > Modbus RTU (Master) or Modbus ASCII (Master), the Modbus RTU/ASCII modules preset in the [Module Setting] will show up in the Module List. (Refer to [Chapter 5.2](#) for the Module Setting.)

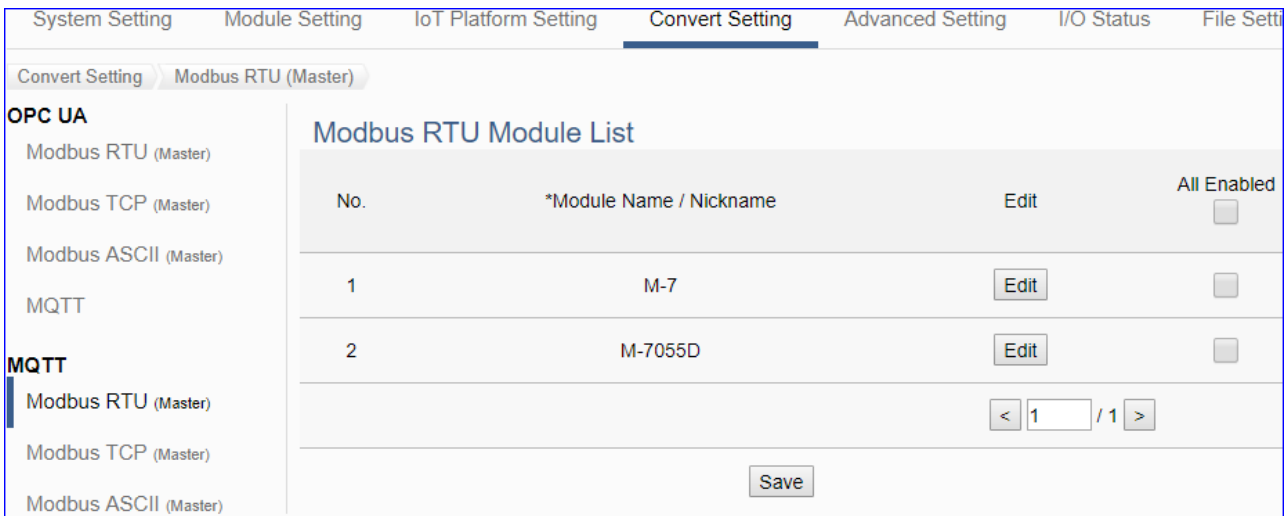

Convert Setting > MQTT > Modbus RTU (Master) Module List	
No.	The module number in the module list (Not editable here)
*Module Name / Nickname	The module name set in the module list (Not editable here)
All Enabled <input type="checkbox"/> Enable <input type="checkbox"/>	Check [All Enabled] box to enable all modules in list for conversion. Default: Uncheck. Check the box of each module can enable just that module for conversion.
Edit	Click to enter the “MQTT Client Setting” page to enable I/O or set up the Topic, QoS, Publish, Subscribe ...
<input type="button" value="&lt;"/> <input type="text" value="1"/> / 1 <input type="button" value="&gt;"/>	The page number of the module list: Current page / Total pages. Click < or > to go to the previous or next page.
Save	Click to save the settings of this page.

This function is to enable the communication conversion module, please  check the box of the converting module. If user wants to enable some I/O of the module, please click [Edit] button to enter the “MQTT Client Setting” page.

The “MQTT Client Setting” page after clicking the [Edit] button:

MQTT Client Setting	
No.	<input type="text" value="1"/>
Module Name	<input type="text" value="Example1"/>
Scan Rate(ms)	<input type="text" value="1000"/>
Dead Band	<input type="text" value="0"/>
Will Topic	<input type="text"/>
Will	<input type="text"/>
MQTT Connection	<input checked="" type="checkbox"/> Broker (Local) <input type="checkbox"/> Broker1 (Remote)

Convert Setting > MQTT > Modbus RTU (Master) – MQTT Client Setting	
No.	The module number in the module list (Un-editable)
Module Name	The module name set in the module list (Not editable here)
Scan Rate(ms)	Set an update frequency for the task data. Default: 1000 (Unit: ms)
Dead Bend	Give a dead bend value for updating a <b>float</b> signal. Default: 0 Dead Band: The minimum amount by which the tag value must change in order for the new tag value to be saved.
Will Topic	Enter the title of a disconnect notice. Default: Null.
Will	Enter a disconnect notice. Default: Null.
MQTT Connection	Check the Broker for this MQTT connection, Local Broker or Remote Broker. Remote Broker option will appear only when set in advance.

**Publish & Subscribe**

Details

Name	Attribute	Data Type	Subscribe Topic	Subscribe QoS	Publish Topic	Publish QoS	Retain	Enabled
Tag0	Read	Short		2	/MRTU_No.1_M-7/Input_Registers/Tag0/Publish	2	<input type="checkbox"/>	<input type="checkbox"/>
Tag0	Read / Write	Short	/MRTU_No.1_M-7/Holding_Registers/Tag0/Subscribe	2	/MRTU_No.1_M-7/Holding_Registers/Tag0/Publish	2	<input type="checkbox"/>	<input type="checkbox"/>
Tag0	Read	Bool		2	/MRTU_No.1_M-7/Input_Status/Tag0/Publish	2	<input type="checkbox"/>	<input type="checkbox"/>
Tag0	Read / Write	Bool	/MRTU_No.1_M-7/Coil_Status/Tag0/Subscribe	2	/MRTU_No.1_M-7/Coil_Status/Tag0/Publish	2	<input type="checkbox"/>	<input type="checkbox"/>
Tag1	Read / Write	Bool	/MRTU_No.1_M-7/Coil_Status/Tag1/Subscribe	2	/MRTU_No.1_M-7/Coil_Status/Tag1/Publish	2	<input type="checkbox"/>	<input type="checkbox"/>

<b>Convert Setting &gt; MQTT &gt; Modbus RTU (Master) – Publish &amp; Subscribe</b>	
Details	Click [Show] to display all fields, click [Hide] to hide some fields.
Name	The variable name of the mapping address. (Not editable here)
Attribute	Display data attribute of the variable. (Not editable) Include: Read, Read/Write...
Data Type	Display data type of the variable that set in the Modbus Address Mapping Table page. (Not editable) Include: Bool, Short, Float...
Subscribe Topic	The topic of receiving/subscribing data message.
Subscribe QoS	The subscribe QoS (Quality of Service) levels. Default: 2 0: Delivering a message at most once. 1: Delivering a message at least once. 2: Delivering a message at exactly once.
Publish Topic	The topic of sending/publishing data message.
Publish QoS	The publish QoS (Quality of Service) levels. Default: 2 0: Delivering a message at most once. 1: Delivering a message at least once. 2: Delivering a message at exactly once.
Retain	Check [Retain] box of the top row can store the broker message for all variables in list. Check the box of each variable can store the broker message just that variable. Default: Uncheck.
Enabled	Check [Enabled] box of the top row can enable all variables in list. Check the box of each variable can enable just that variable for conversion. Default: Uncheck.
OK	Click to save this page settings and back to the module list page.

### 5.4.8 MQTT and Modbus TCP Conversion

This page provides MQTT and Modbus TCP (Master) communication protocol conversion. With the MQTT Service function, users can set the MQTT client to publish the message to the specified broker or subscribe the topic, and so to read and write the single channel of the Modbus device that connected to the controller.

For the certificate about the communication security, please refer to [Chapter 7](#).

#### Function Diagram:

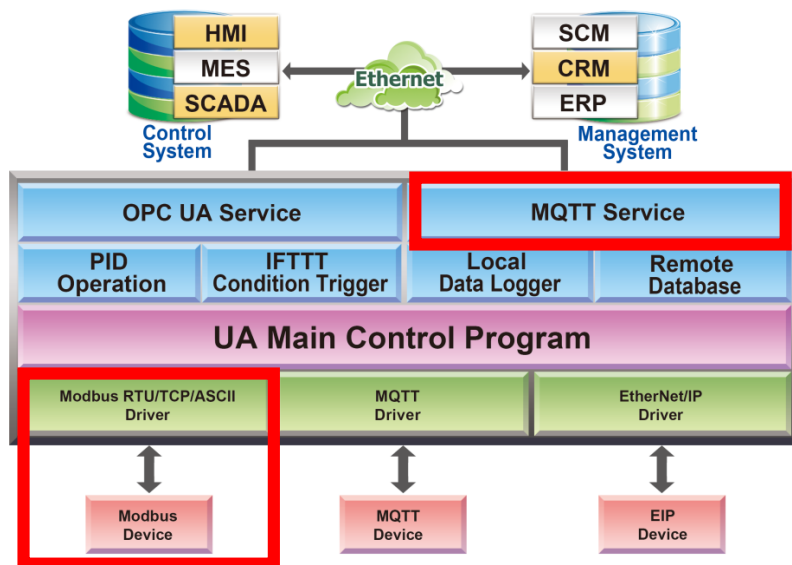

#### Application Solution:



When entering the menu [Convert Setting] and the sub-menu [MQTT] > Modbus TCP (Master), the Modbus TCP modules preset in the [Module Setting] will show up in the Module List. (Refer to Chapter 5.2 for the Module Setting.)

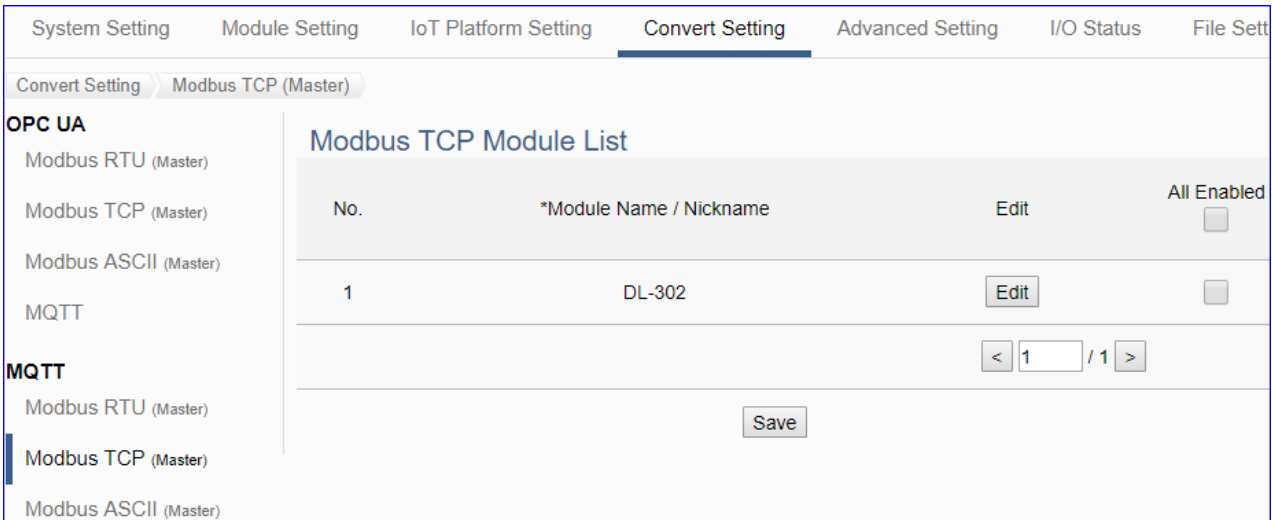

Convert Setting > MQTT > Modbus RTU (Master) Module List	
No.	The module number in the module list (Not editable here)
*Module Name / Nickname	The module name set in the module list (Not editable here)
All Enabled <input type="checkbox"/> Enable <input type="checkbox"/>	Check [All Enabled] box to enable all modules in list for conversion. Default: Uncheck. Check the box of each module can enable just that module for conversion.
Edit	Click to enter the “MQTT Client Setting” page to enable I/O or set up the Topic, QoS, Publish, Subscribe ...
<input type="button" value="1"/> / 1	The page number of the module list: Current page / Total pages. Click < or > to go to the previous or next page.
Save	Click to save the settings of this page.

This function is to enable the communication conversion module, please  check the box of the converting module. If user wants to enable some I/O of the module, please click [Edit] button to enter the “MQTT Client Setting” page.

The “MQTT Client Setting” page after clicking the [Edit] button:

MQTT Client Setting	
No.	<input type="text" value="1"/>
Module Name	<input type="text" value="Example1"/>
Scan Rate(ms)	<input type="text" value="1000"/>
Dead Band	<input type="text" value="0"/>
Will Topic	<input type="text"/>
Will	<input type="text"/>
MQTT Connection	<input checked="" type="checkbox"/> Broker (Local) <input type="checkbox"/> Broker1 (Remote)

Convert Setting > MQTT > Modbus TCP (Master) – MQTT Client Setting	
No.	The module number in the module list (Un-editable)
Module Name	The module name set in the module list (Not editable here)
Scan Rate(ms)	Set an update frequency for the task data. Default: 1000 (Unit: ms)
Dead Bend	Give a dead bend value for updating a <b>float</b> signal. Default: 0 Dead Band: The minimum amount by which the tag value must change in order for the new tag value to be saved.
Will Topic	Enter the title of a disconnect notice. Default: Null.
Will	Enter a disconnect notice. Default: Null.
MQTT Connection	Check the Broker for this MQTT connection, Local Broker or Remote Broker. Remote Broker option will appear only when set in advance.

**Publish & Subscribe**

Details

Name	Attribute	Data Type	Subscribe Topic	Subscribe QoS	Publish Topic	Publish QoS	Retain	Enabled
Tag0	Read	Float	/MRTU_No.1_Name1/Input_Registers/Tag0/Subscribe	2		2	<input type="checkbox"/>	<input type="checkbox"/>
Tag0	Read / Write	Short	/MRTU_No.1_Name1/Holding_Registers/Tag0/Subscribe	2	/MRTU_No.1_Name1/Holding_Registers/Tag0/Publish	2	<input type="checkbox"/>	<input type="checkbox"/>
Tag0	Read	Bool	/MRTU_No.1_Name1/Input_Status/Tag0/Subscribe	2		2	<input type="checkbox"/>	<input type="checkbox"/>
Tag0	Read / Write	Bool	/MRTU_No.1_Name1/Coil_Status/Tag0/Subscribe	2	/MRTU_No.1_Name1/Coil_Status/Tag0/Publish	2	<input type="checkbox"/>	<input type="checkbox"/>
Tag1	Read / Write	Bool	/MRTU_No.1_Name1/Coil_Status/Tag1/Subscribe	2	/MRTU_No.1_Name1/Coil_Status/Tag1/Publish	2	<input type="checkbox"/>	<input type="checkbox"/>

<b>Convert Setting &gt; MQTT &gt; Modbus TCP (Master) – Publish &amp; Subscribe</b>	
Details	Click [Show] to display all fields, click [Hide] to hide some fields.
Name	The variable name of the mapping address. (Not editable here)
Attribute	Display data attribute of the variable. (Not editable) Include: Read, Read/Write...
Data Type	Display data type of the variable that set in the Modbus Address Mapping Table page. (Not editable) Include: Bool, Short, Float...
Subscribe Topic	The topic of receiving/subscribing data message.
Subscribe QoS	The subscribe QoS (Quality of Service) levels. Default: 2 0: Delivering a message at most once. 1: Delivering a message at least once. 2: Delivering a message at exactly once.
Publish Topic	The topic of sending/publishing data message.
Publish QoS	The publish QoS (Quality of Service) levels. Default: 2 0: Delivering a message at most once. 1: Delivering a message at least once. 2: Delivering a message at exactly once.
Retain	Check [Retain] box of the top row can store the broker message for all variables in list. Check the box of each variable can store the broker message just that variable. Default: Uncheck.
Enabled	Check [Enabled] box of the top row can enable all variables in list. Check the box of each variable can enable just that variable for conversion. Default: Uncheck.
OK	Click to save this page settings and back to the module list page.

### 5.4.9 MQTT and EtherNet/IP Conversion

This page provides MQTT and EtherNet/IP communication protocol conversion. With this MQTT Service function, users can set the MQTT client to publish the message to the specified broker or subscribe the topic, and so to read and write the single channel of the ICP DAS EIP-2000 device that connected to the controller.

For the certificate about the communication security, please refer to [Chapter 7](#).

#### Function Diagram:

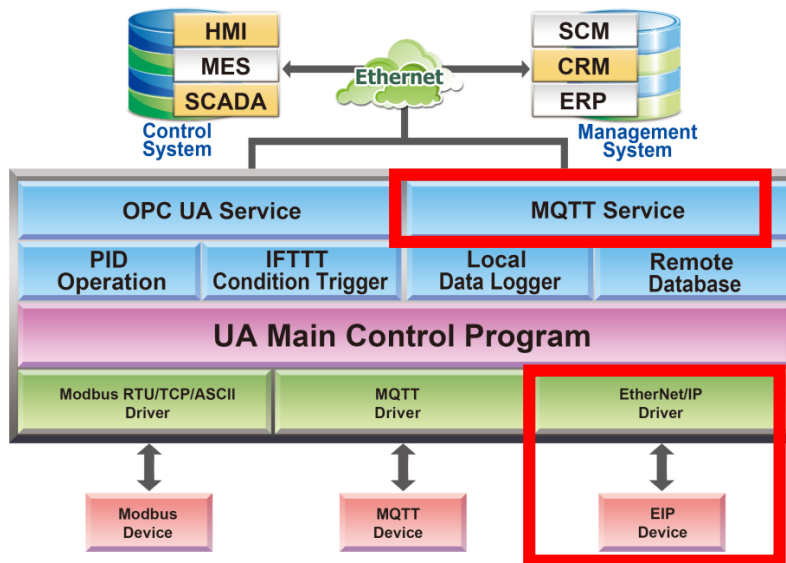

#### Application Solution:



When entering the menu [Convert Setting] and the sub-menu [MQTT] > EtherNet/IP, the ICP DAS EtherNet/IP modules EIP Series preset in the [Module Setting] will show up in the Module List. (Refer to [Chapter 5.2](#) for the Module Setting.)

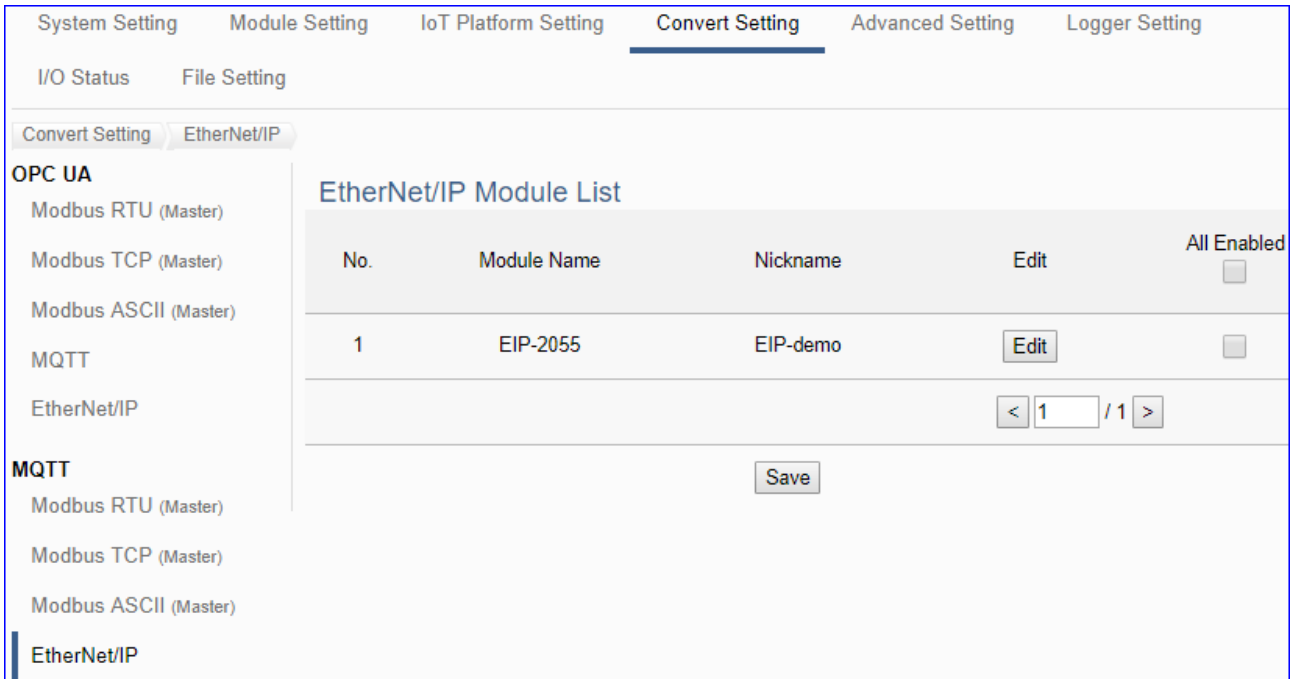

Convert Setting > MQTT > EtherNet/IP Module List	
No.	The module number in the module list (Not editable here)
Module Name	The EIP series model selected in the module list (Not editable here)
Nickname	The user defined name for the module (Not editable here)
All Enabled <input type="checkbox"/> Enable <input type="checkbox"/>	Check [All Enabled] box to enable all modules in list for conversion. Default: Uncheck. Check the box of each module can enable just that module for conversion.
Edit	Click to enter the “MQTT Client Setting” page to enable I/O or set up the Topic, QoS, Publish, Subscribe ...
<input type="button" value="1"/> / <input type="button" value="1"/>	The page number of the module list: Current page / Total pages. Click < or > to go to the previous or next page.
Save	Click to save the settings of this page.

**This function is to enable the communication conversion module, please  check the box of the converting module. If user wants to enable some I/O of the module, please click [Edit] button to enter the “MQTT Client Setting” page.**

The “MQTT Client Setting” page after clicking the [Edit] button:

MQTT Client Setting	
No.	<input type="text" value="1"/>
Module Name	<input type="text" value="Example1"/>
Scan Rate(ms)	<input type="text" value="1000"/>
Dead Band	<input type="text" value="0"/>
Will Topic	<input type="text"/>
Will	<input type="text"/>
MQTT Connection	<input checked="" type="checkbox"/> Broker (Local) <input type="checkbox"/> Broker1 (Remote)

Convert Setting > MQTT > EtherNet/IP – MQTT Client Setting	
No.	The module number in the module list (Un-editable)
Module Name	The module name set in the module list (Not editable here)
Scan Rate(ms)	Set an update frequency for the task data. Default: 1000 (Unit: ms)
Dead Bend	Give a dead bend value for updating a <b>float</b> signal. Default: 0 Dead Band: The minimum amount by which the tag value must change in order for the new tag value to be saved.
Will Topic	Enter the title of a disconnect notice. Default: Null.
Will	Enter a disconnect notice. Default: Null.
MQTT Connection	Check the Broker for this MQTT connection, Local Broker or Remote Broker. Remote Broker option will appear only when set in advance.

**Publish & Subscribe**

Details

Name	Attribute	Data Type	Subscribe Topic	Subscribe QoS	Publish Topic	Publish QoS	Retain	Enabled
<input type="text" value="Tag0"/>	Read ▾	Float	<input type="text" value="/MRTU_No.1_Name1/Input_Registers/Tag0/Subscribe"/>	2 ▾	<input type="text" value=""/>	2 ▾	<input type="checkbox"/>	<input type="checkbox"/>
<input type="text" value="Tag0"/>	Read / Write ▾	Short	<input type="text" value="/MRTU_No.1_Name1/Holding_Registers/Tag0/Subscribe"/>	2 ▾	<input type="text" value="/MRTU_No.1_Name1/Holding_Registers/Tag0/Publish"/>	2 ▾	<input type="checkbox"/>	<input type="checkbox"/>
<input type="text" value="Tag0"/>	Read ▾	Bool	<input type="text" value="/MRTU_No.1_Name1/Input_Status/Tag0/Subscribe"/>	2 ▾	<input type="text" value=""/>	2 ▾	<input type="checkbox"/>	<input type="checkbox"/>
<input type="text" value="Tag0"/>	Read / Write ▾	Bool	<input type="text" value="/MRTU_No.1_Name1/Coil_Status/Tag0/Subscribe"/>	2 ▾	<input type="text" value="/MRTU_No.1_Name1/Coil_Status/Tag0/Publish"/>	2 ▾	<input type="checkbox"/>	<input type="checkbox"/>
<input type="text" value="Tag1"/>	Read / Write ▾	Bool	<input type="text" value="/MRTU_No.1_Name1/Coil_Status/Tag1/Subscribe"/>	2 ▾	<input type="text" value="/MRTU_No.1_Name1/Coil_Status/Tag1/Publish"/>	2 ▾	<input type="checkbox"/>	<input type="checkbox"/>

<b>Convert Setting &gt; MQTT &gt; EtherNet/IP – Publish &amp; Subscribe</b>	
Details	Click [Show] to display all fields, click [Hide] to hide some fields.
Name	The variable name of the mapping address. (Not editable here)
Attribute	Display data attribute of the variable. (Not editable) Include: Read, Read/Write...
Data Type	Display data type of the variable that set in the Modbus Address Mapping Table page. (Not editable) Include: Bool, Short, Float...
Subscribe Topic	The topic of receiving/subscribing data message.
Subscribe QoS	The subscribe QoS (Quality of Service) levels. Default: 2 0: Delivering a message at most once. 1: Delivering a message at least once. 2: Delivering a message at exactly once.
Publish Topic	The topic of sending/publishing data message.
Publish QoS	The publish QoS (Quality of Service) levels. Default: 2 0: Delivering a message at most once. 1: Delivering a message at least once. 2: Delivering a message at exactly once.
Retain	Check [Retain] box of the top row can store the broker message for all variables in list. Check the box of each variable can store the broker message just that variable. Default: Uncheck.
Enabled	Check [Enabled] box of the top row can enable all variables in list. Check the box of each variable can enable just that variable for conversion. Default: Uncheck.
OK	Click to save this page settings and back to the module list page.

### 5.4.10 MQTT JSON and Modbus RTU/ASCII Conversion

This page provides MQTT JSON and Modbus RTU/ASCII (Master) communication protocol conversion. With the MQTT Service function, users can set the MQTT client to publish the message to the specified broker or subscribe the topic, and combine several messages that converted in JSON format into a group to read and write the multiple channels of the Modbus RTU/ASCII devices that connected to the controller.

The settings of Modbus RTU/ASCII are the same. Here will introduce them together. For the certificate about the communication security, please refer to [Chapter 7](#).

#### Function Diagram:

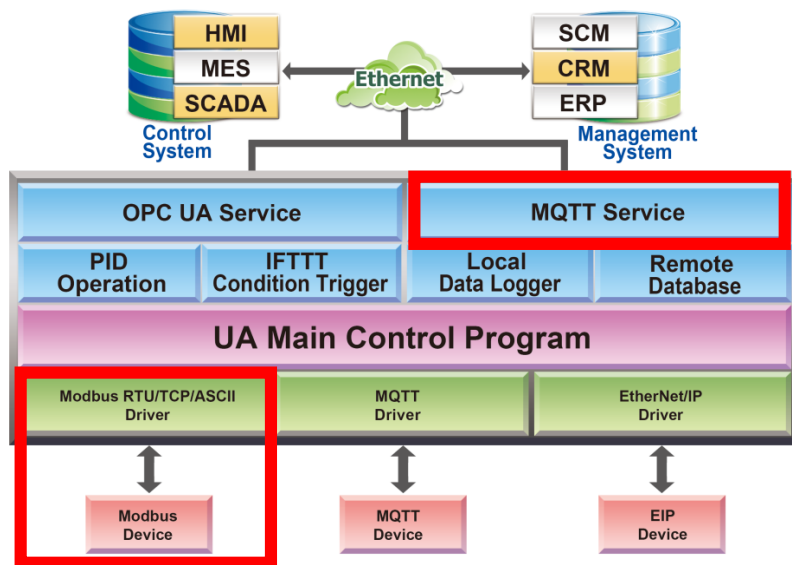

#### Application Solution:

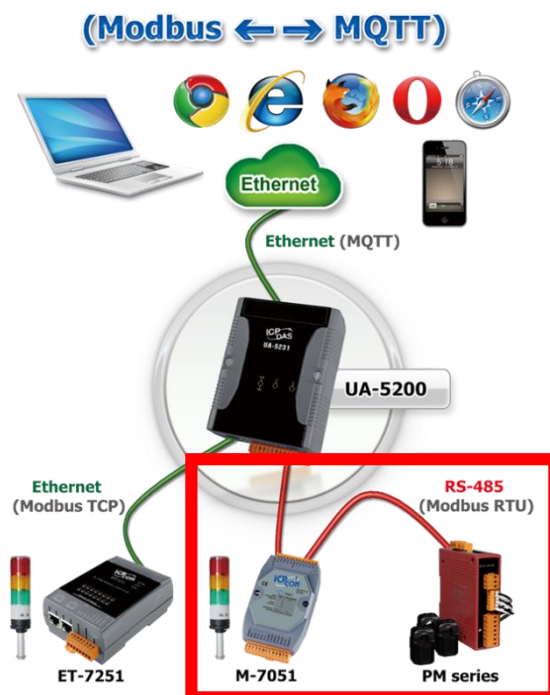

When entering the menu [Convert Setting] and the sub-menu [MQTT JSON] > Modbus RTU or Modbus ASCII (Master), the Modbus RTU/ASCII modules preset in the [Module Setting] will show up in the Module List. (Refer to [Chapter 5.2](#) for the Module Setting.)

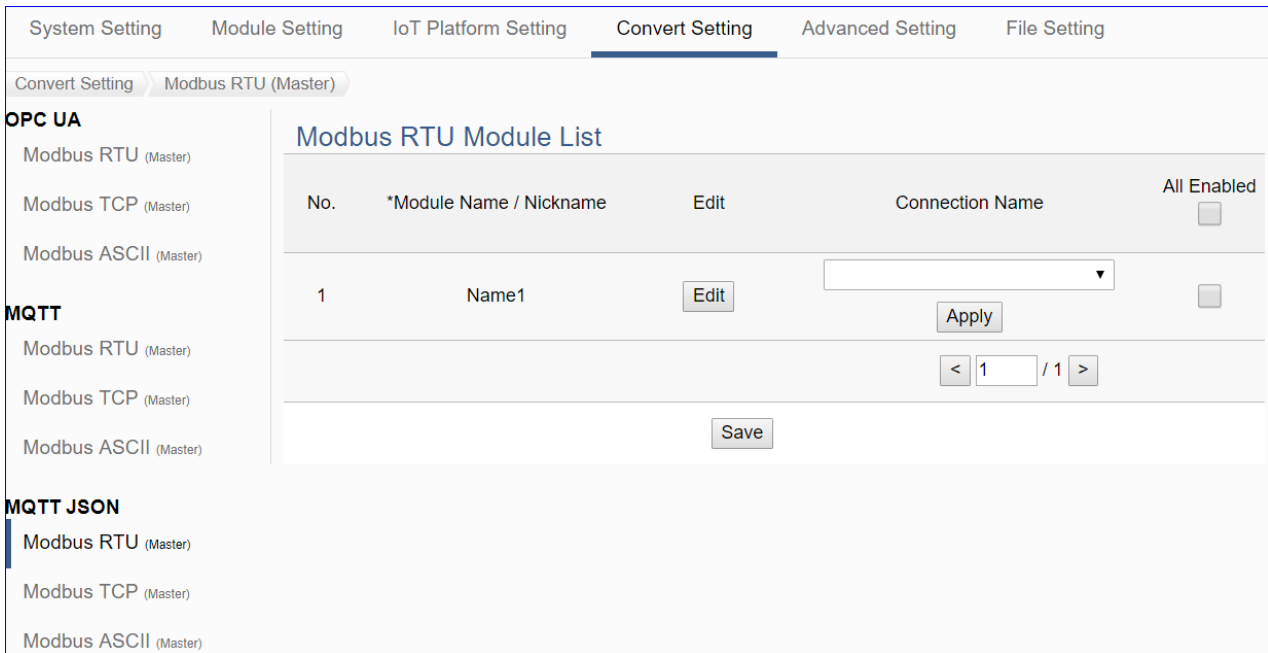

Convert Setting > MQTT JSON > Modbus RTU (Master) Module List	
No.	The module number in the module list (Not editable here)
*Module Name / Nickname	The module name set in the module list (Not editable here)
Connection Name	Select a group connection name, and then click [Apply].
All Enabled <input type="checkbox"/> <input type="checkbox"/> Enable	Check [All Enabled] box to enable all modules in list for conversion. Default: Uncheck. Check the box of each module can enable just that module for conversion.
Edit	If user wants to enable some I/O channels for conversion, click [Edit] of that module to enable I/O or check the “Module Content Setting” and “Variable Tale” page.
<input type="button" value="&lt;"/> <input type="text" value="1"/> / 1 <input type="button" value="&gt;"/>	The page number of the module list: Current page / Total pages. Click < or > to go to the previous or next page.
Save	Click to save the settings of this page.

This function is to enable the communication conversion module, first select the [Connection Name] and click [Apply] button, and then check the box  of the converting module. If user wants to enable some I/O of the module, please click [Edit] button to enter the “Module Content Setting” page.

### Module Content Setting

No.	<input type="text" value="1"/>
Module Name	<input type="text" value="Example1"/>

### Variable Table

Details	<input type="button" value="Show"/>	<input type="button" value="Hide"/>
---------	-------------------------------------	-------------------------------------

Variable Name	Alias	Attribute	Data Type	Connection Name	Enabled
<input type="text" value="Tag0"/>	<input type="text" value="Tag0"/>	<input type="text" value="Read"/>	Float	<input type="text"/>	<input type="checkbox"/>
<input type="text" value="Tag0"/>	<input type="text" value="Tag0"/>	<input type="text" value="Read / Write"/>	Short	<input type="text"/>	<input type="checkbox"/>
<input type="text" value="Tag0"/>	<input type="text" value="Tag0"/>	<input type="text" value="Read"/>	Bool	<input type="text"/>	<input type="checkbox"/>
<input type="text" value="Tag1"/>	<input type="text" value="Tag1"/>	<input type="text" value="Read"/>	Bool	<input type="text"/>	<input type="checkbox"/>
<input type="text" value="Tag0"/>	<input type="text" value="Tag0"/>	<input type="text" value="Read / Write"/>	Bool	<input type="text"/>	<input type="checkbox"/>
<input type="text" value="Tag1"/>	<input type="text" value="Tag1"/>	<input type="text" value="Read / Write"/>	Bool	<input type="text"/>	<input type="checkbox"/>

<b>Convert Setting &gt; MQTT JSON &gt; Modbus RTU (Master) – Module Content Setting</b>	
No.	The module number in the module list (Not editable here)
Module Name	The module name set in the module list (Not editable here)
<b>Convert Setting &gt; MQTT JSON &gt; Modbus RTU (Master) – Variable Table</b>	
Details	Click [Show] to display all fields, click [Hide] to hide some fields.
Variable Name	The variable name of the mapping address. (Not editable here)
Alias	The user cannot change the variable name but can set an alias for data separation and identification. It is used in the "Name" element parameter of the MQTT JSON format. Refer to Appendix A.
Attribute	Display data attribute of the variable. (Not editable) Include: Read, Read/Write...
Data Type	Display data type of the variable that set in the Modbus Address Mapping Table page. (Not editable) Include: Bool, Short, Float...
Connection Name	Select the group name that set in the group list page.
Enabled	Check [Enabled] box of the top row can enable all variables in list. Check the box of each variable can enable just that variable for conversion. Default: Uncheck.
OK	Click to save this page settings and back to the module list page.

### 5.4.11 MQTT JSON and Modbus TCP Conversion

This page provides MQTT JSON and Modbus TCP (Master) communication protocol conversion. With the MQTT Service function, users can set the MQTT client to publish the message to the specified broker or subscribe the topic, and combine several messages that converted in JSON format into a group to read and write the multiple channels of the Modbus TCP devices that connected to the controller.

For the certificate about the communication security, please refer to [Chapter 7](#).

#### Function Diagram:

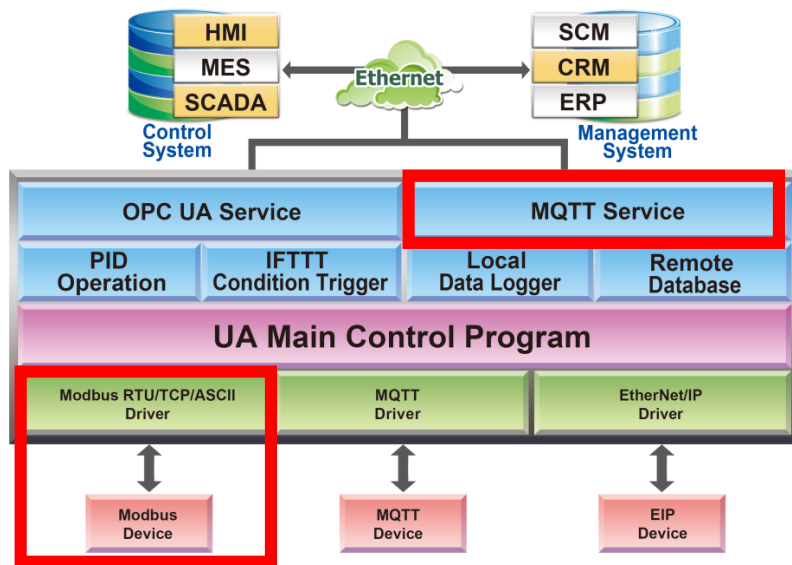

#### Application Solution:



When entering the menu [Convert Setting] and the sub-menu [MQTT JSON] > Modbus TCP (Master), the Modbus TCP modules preset in the [Module Setting] will show up in the Module List. (Refer to Chapter 5.2 for the Module Setting.)

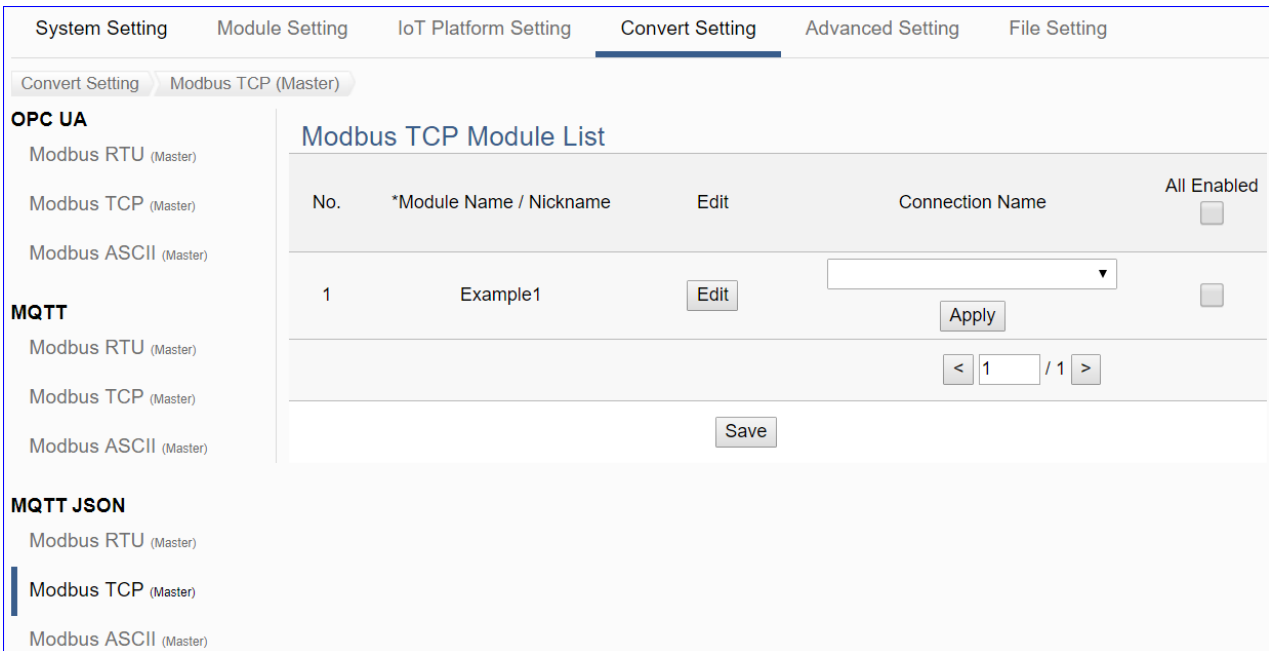

Convert Setting > MQTT JSON > Modbus TCP (Master) Module List	
No.	The module number in the module list (Not editable here)
*Module Name / Nickname	The module name set in the module list (Not editable here)
Connection Name	Select a group connection name, and then click [Apply].
Edit	If user wants to enable some I/O channels for conversion, click [Edit] of that module to enter the “Module Content Setting” and “Variable Tale” page.
All Enabled <input type="checkbox"/> Enable <input type="checkbox"/>	Check [All Enabled] box to enable all modules in list for conversion. Default: Uncheck. Check the box of each module can enable just that module for conversion.
<input type="button" value="&lt;"/> <input type="text" value="1"/> / 1 <input type="button" value="&gt;"/>	The page number of the module list: Current page / Total pages. Click < or > to go to the previous or next page.
Save	Click to save the settings of this page.

This function is to enable the communication conversion module, first select the [Connection Name] and click [Apply] button, and then check the box  of the converting module. If user wants to enable some I/O of the module, please click [Edit] button to enter the “Module Content Setting” page.

### Module Content Setting

No.	<input type="text" value="1"/>
Module Name	<input type="text" value="Example1"/>

### Variable Table

Details	<input type="button" value="Show"/>	<input type="button" value="Hide"/>
---------	-------------------------------------	-------------------------------------

Variable Name	Alias	Attribute	Data Type	Connection Name	Enabled
<input type="text" value="Tag0"/>	<input type="text" value="Tag0"/>	<input type="text" value="Read"/>	Float	<input type="text"/>	<input type="checkbox"/>
<input type="text" value="Tag0"/>	<input type="text" value="Tag0"/>	<input type="text" value="Read / Write"/>	Short	<input type="text"/>	<input type="checkbox"/>
<input type="text" value="Tag0"/>	<input type="text" value="Tag0"/>	<input type="text" value="Read"/>	Bool	<input type="text"/>	<input type="checkbox"/>
<input type="text" value="Tag1"/>	<input type="text" value="Tag1"/>	<input type="text" value="Read"/>	Bool	<input type="text"/>	<input type="checkbox"/>
<input type="text" value="Tag0"/>	<input type="text" value="Tag0"/>	<input type="text" value="Read / Write"/>	Bool	<input type="text"/>	<input type="checkbox"/>
<input type="text" value="Tag1"/>	<input type="text" value="Tag1"/>	<input type="text" value="Read / Write"/>	Bool	<input type="text"/>	<input type="checkbox"/>

<b>Convert Setting &gt; MQTT JSON &gt; Modbus TCP (Master) – Module Content Setting</b>	
No.	The module number in the module list (Not editable here)
Module Name	The module name set in the module list (Not editable here)
<b>Convert Setting &gt; MQTT JSON &gt; Modbus TCP (Master) – Variable Table</b>	
Details	Click [Show] to display all fields, click [Hide] to hide some fields.
Variable Name	The variable name of the mapping address. (Not editable here)
Alias	The user cannot change the variable name but can set an alias for data separation and identification. It is used in the "Name" element parameter of the MQTT JSON format. Refer to Appendix A.
Attribute	Display data attribute of the variable. (Not editable) Include: Read, Read/Write...
Data Type	Display data type of the variable that set in the Modbus Address Mapping Table page. (Not editable) Include: Bool, Short, Float...
Connection Name	Select the group name that set in the group list page.
Enabled	Check [Enabled] box of the top row can enable all variables in list. Check the box of each variable can enable just that variable for conversion. Default: Uncheck.
OK	Click to save this page settings and back to the module list page.

### 5.4.12 MQTT Custom and IoT Cloud Conversion

This page provides customized MQTT communication conversion for the IoT Cloud Platform. Users can customize the MQTT format layout and add the module value to the publishing message. With customized MQTT message content, this function can support multiple IoT platforms.

For the certificate about the communication security, please refer to [Chapter 7](#).

#### Function Diagram:

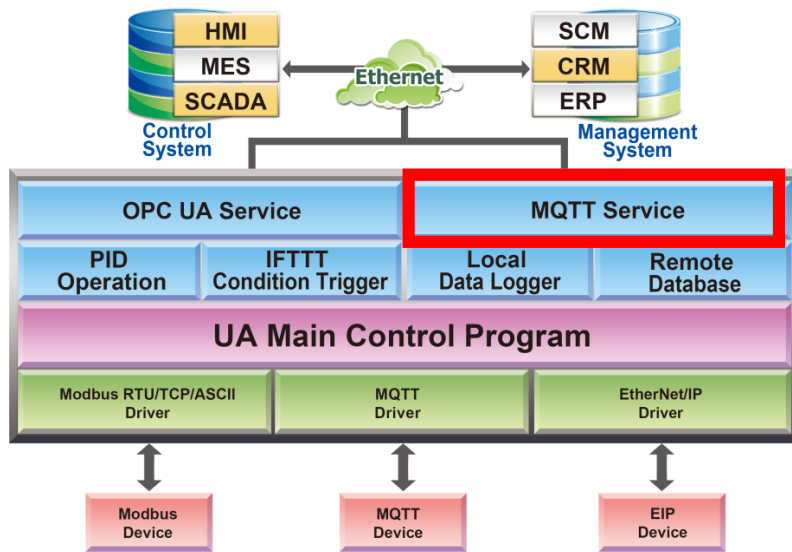

#### Application Solution:

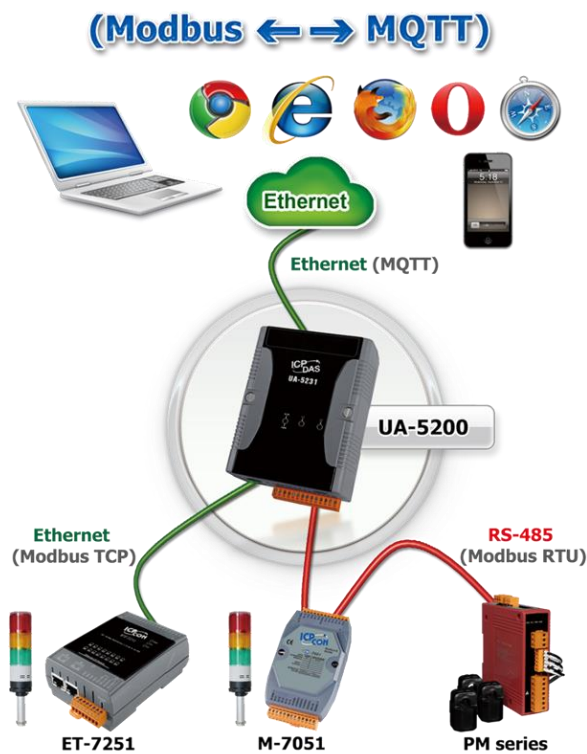

Enter the menu [Convert Setting] and the sub-menu [MQTT Custom] > [IoT Cloud], then can set up the customized MQTT IoT Cloud settings.

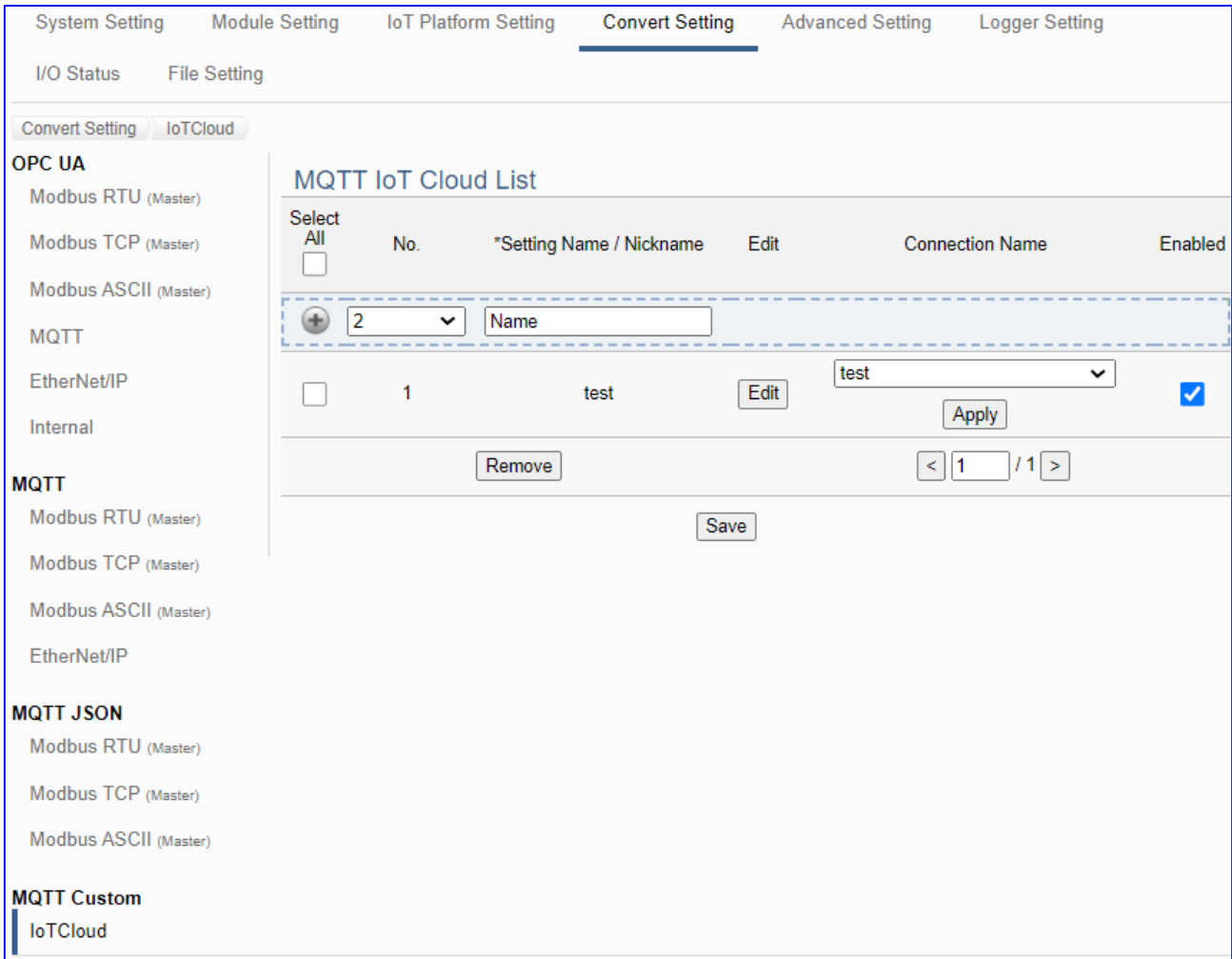

Convert Setting > MQTT Custom > IoTCloud – MQTT IoT Cloud List	
No.	The number in the IoT Cloud list (Not editable here)
*Setting Name / Nickname	The Setting name or Nickname set in the IoT Cloud list (editable)
Edit	Click the [Edit] button to enter the Module List, select the module and set up the message to be published.
Connection Name	Select a connection name set in the step of the “IoT Platform”, and then click [Apply].
Enabled <input type="checkbox"/>	Check the box of list to enable that conversion. Default: Enable
<input type="button" value="1"/> / <input type="button" value="1"/>	The page number of the list: Current page / Total pages. Click < or > to go to the previous or next page.
Save	Click to save the settings of this page.

Click [Edit] button to enter the Module List page, the modules preset in the [Module Setting] will show up in the selected items. (Refer to [Chapter 5.2](#) for the Module Setting.)

**MQTT IoT Cloud Module List**

No.

Setting Name

---

Data Setting

Type :

No. :

Name :

Attribute :

TagName :

---

Send Message

AI0:\$MRTU\_No.1\_M-7017C\_AI.AI0\$  
 AI1:\$MRTU\_No.1\_M-7017C\_AI.AI1\$

Convert Setting > MQTT Custom > IoT Cloud – MQTT IoT Cloud Module List	
No.	The number in the IoT Cloud setting list (Cannot be changed here)
Setting Name	The setting name set in the IoT Cloud list, can change it here.
Type	The user can find out the variable name of the current module tags through the following steps: 1. Select the type of module. 2. Select the number of the set module you want to use. 3. Select the module name you want to use. 4. Select the tag attribute of the module. 5. Select the tag name of the module.
No.	
Name	
Attribute	
Tag Name	
Insert	Click "Insert" to add the variable name of the module tag to the "Send Message" field.
Send Message	Message format editing interface, user can click the insert button to add I/O tags and then edit the messages.
OK / Cancel	Click [OK] to save the settings of this page, and exit. Click [Cancel] to exit this page but do not save the settings.

### 5.4.13 SNMP and Modbus RTU Conversion

This page provides SNMP and Modbus RTU (Master) communication protocol conversion. With this function, the SNMP Agent can read and write the Modbus RTU device that connected to the controller.

The **SNMP** function is the advanced functions only available in the UA-2800 series, and it's not supported by the UA-5200/2200 series.

Function Diagram:

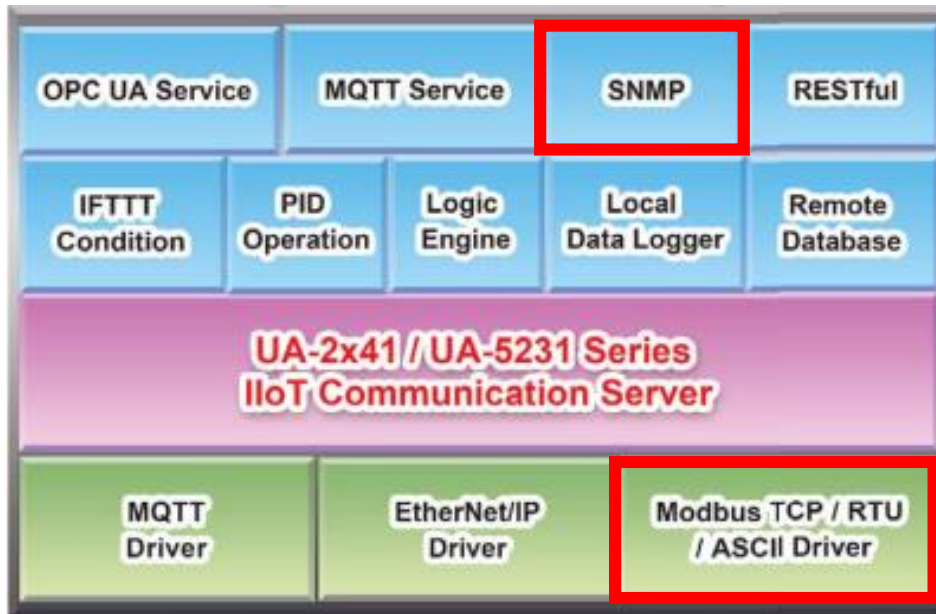

When entering the menu [Convert Setting] and the sub-menu [SNMP] > Modbus RTU (Master), the Modbus RTU modules preset in the [Module Setting] will show up in the Module List. (Refer to Chapter 5.2 for the Module Setting.)

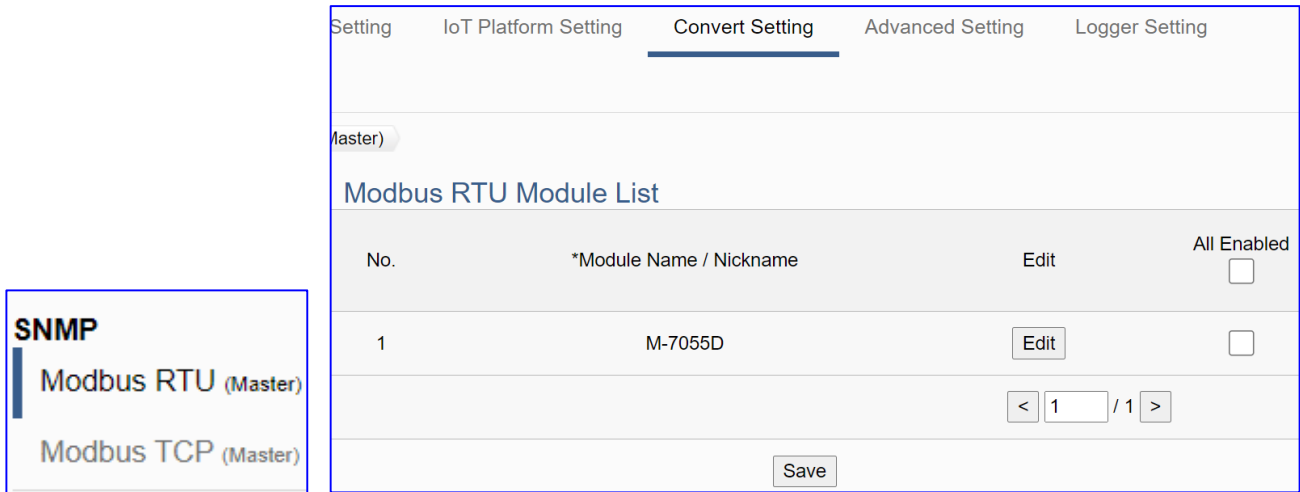

Convert Setting > SNMP > Modbus RTU Module List	
No.	The module number in the module list (Not editable here)
*Module Name / Nickname	The module name set in the module list (Not editable here)
Edit	If user wants to enable some I/O channels for conversion, click [Edit] of that module to enable I/O or check the “Module Content Setting” and “Variable Tale” page.
All Enabled <input type="checkbox"/> Enable <input type="checkbox"/>	Check [All Enabled] box to enable all modules in list for conversion. Default: Uncheck. Check the box of each module can enable just that module for conversion.
<input type="button" value="&lt;"/> <input type="text" value="1"/> / 1 <input type="button" value="&gt;"/>	The page number of the module list: Current page / Total pages. Click < or > to go to the previous or next page.
Save	Click to save the settings of this page.

This function is to enable the communication conversion module, please  check the box of the converting module. If user wants to enable some I/O of the module, please click [Edit] button to enter the “Module Content Setting” page.

**Module Content Setting**

No.

---

Module Name

---

**Variable Table**

Name	Attribute	Data Type	Variable OID	Enabled
<input type="text" value="DI0"/>	Read <input type="text"/>	Bool	<input type="text" value=".1.3.6.1.4.1.34321.50.1.1.1"/>	<input checked="" type="checkbox"/>
<input type="text" value="DI1"/>	Read <input type="text"/>	Bool	<input type="text" value=".1.3.6.1.4.1.34321.50.1.1.1"/>	<input checked="" type="checkbox"/>
<input type="text" value="DI2"/>	Read <input type="text"/>	Bool	<input type="text" value=".1.3.6.1.4.1.34321.50.1.1.1"/>	<input checked="" type="checkbox"/>
<input type="text" value="DI3"/>	Read <input type="text"/>	Bool	<input type="text" value=".1.3.6.1.4.1.34321.50.1.1.1"/>	<input checked="" type="checkbox"/>
<input type="text" value="DO6"/>	Read / Write <input type="text"/>	Bool	<input type="text" value=".1.3.6.1.4.1.34321.50.1.1.2"/>	<input type="checkbox"/>
<input type="text" value="DO7"/>	Read / Write <input type="text"/>	Bool	<input type="text" value=".1.3.6.1.4.1.34321.50.1.1.2"/>	<input type="checkbox"/>

<b>Convert Setting &gt; SNMP &gt; Modbus RTU (Master) – Module Content Setting</b>	
No.	The module number in the module list (Not editable here)
Module Name	The module name set in the module list (Not editable here)
<b>Convert Setting &gt; SNMP &gt; Modbus RTU (Master) – Variable Table</b>	
Name	Display the variable name that set in the Modbus Address Mapping Table page (Not editable here)
Attribute	Display data attribute of the variable. (Not editable) Include: Read, Read/Write...
Data Type	Display data type of the variable that set in the Modbus Address Mapping Table page. (Not editable) Include: Bool, Short, Float...
Variable OID	The variable OID code of each module I/O channel (automatically assigned by the system)
Enabled	Check [Enabled] box of the top row can enable all variables in list. Check the box of each variable can enable just that variable for conversion. Default: Uncheck.
OK	Click to save this page settings and back to the module list page.

### 5.4.14 SNMP and Modbus TCP Conversion

This page provides SNMP and Modbus TCP (Master) communication protocol conversion. With this function, the SNMP Agent can read and write the Modbus TCP device that connected to the controller.

The SNMP function is the advanced functions only available in the UA-2800 series, and it's not supported by the UA-5200/2200 series.

Function Diagram:

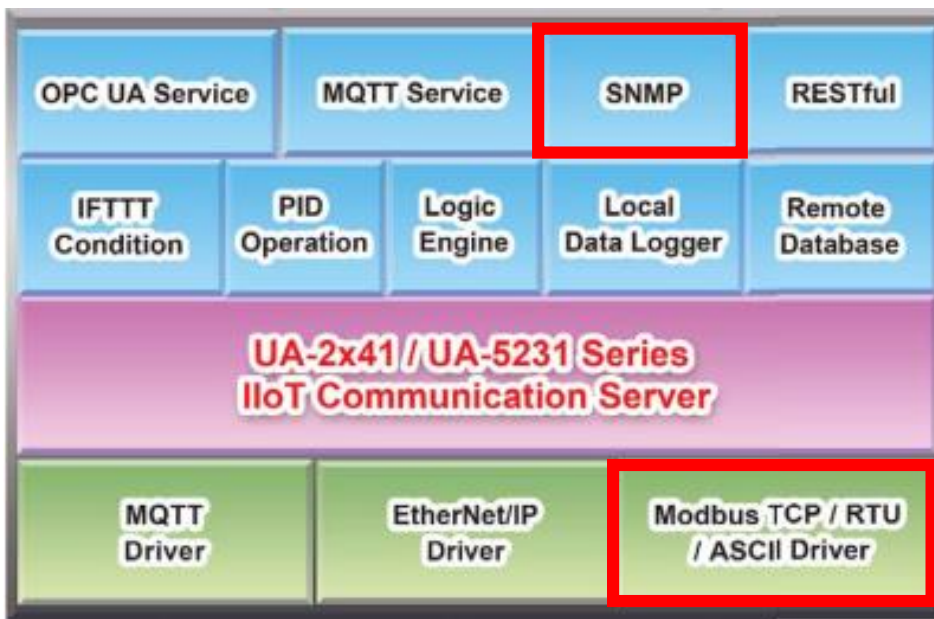

When entering the menu [Convert Setting] and the sub-menu [SNMP] > Modbus RTU (Master), the Modbus RTU modules preset in the [Module Setting] will show up in the Module List. (Refer to Chapter 5.2 for the Module Setting.)

**SNMP**

Modbus RTU (Master)

Modbus TCP (Master)

**Modbus TCP Module List**

No.	*Module Name / Nickname	Edit	All Enabled
1	DL-302	<input type="button" value="Edit"/>	<input type="checkbox"/>
		<input style="width: 20px; height: 20px;" type="button" value=" &lt; "/> <input style="width: 30px; text-align: center; border: 1px solid #ccc;" type="text" value="1"/> <input style="width: 20px; height: 20px;" type="button" value=" / "/> <input style="width: 30px; text-align: center; border: 1px solid #ccc;" type="text" value="1"/> <input style="width: 20px; height: 20px;" type="button" value=" &gt; "/>	
<input style="width: 50px;" type="button" value=" Save "/>			

<b>Convert Setting &gt; SNMP &gt; Modbus TCP Module List</b>	
No.	The module number in the module list (Not editable here)
*Module Name / Nickname	The module name set in the module list (Not editable here)
Edit	If user wants to enable some I/O channels for conversion, click [Edit] of that module to enable I/O or check the “Module Content Setting” and “Variable Tale” page.
All Enabled <input type="checkbox"/> <input type="checkbox"/> Enable	Check [All Enabled] box to enable all modules in list for conversion. Default: Uncheck. Check the box of each module can enable just that module for conversion.
<input style="width: 20px; height: 20px;" type="button" value=" &lt; "/> <input style="width: 30px; text-align: center; border: 1px solid #ccc;" type="text" value="1"/> <input style="width: 20px; height: 20px;" type="button" value=" / "/> <input style="width: 30px; text-align: center; border: 1px solid #ccc;" type="text" value="1"/> <input style="width: 20px; height: 20px;" type="button" value=" &gt; "/>	The page number of the module list: Current page / Total pages. Click < or > to go to the previous or next page.
Save	Click to save the settings of this page.

This function is to enable the communication conversion module, please check the box of the converting module. If user wants to enable some I/O of the module, please click [Edit] button to enter the “Module Content Setting” page.

Module Content Setting				
No.	<input type="text" value="1"/>			
Module Name	<input type="text" value="DL-302"/>			
Variable Table				
Name	Attribute	Data Type	Variable OID	Enabled <input type="checkbox"/>
<input type="text" value="CO2"/>	Read <input type="text"/>	Short	<input type="text" value=".1.3.6.1.4.1.34321.50.2.1.3"/>	<input type="checkbox"/>
<input type="text" value="Relative_hum"/>	Read <input type="text"/>	Short	<input type="text" value=".1.3.6.1.4.1.34321.50.2.1.3"/>	<input type="checkbox"/>
<input type="text" value="Temperature_"/>	Read <input type="text"/>	Short	<input type="text" value=".1.3.6.1.4.1.34321.50.2.1.3"/>	<input type="checkbox"/>
<input type="text" value="Temperature_"/>	Read <input type="text"/>	Short	<input type="text" value=".1.3.6.1.4.1.34321.50.2.1.3"/>	<input type="checkbox"/>
<input type="text" value="Dew_point_te"/>	Read <input type="text"/>	Short	<input type="text" value=".1.3.6.1.4.1.34321.50.2.1.3"/>	<input type="checkbox"/>
<input type="text" value="Dew_point_te"/>	Read <input type="text"/>	Short	<input type="text" value=".1.3.6.1.4.1.34321.50.2.1.3"/>	<input type="checkbox"/>
				<input type="button" value="OK"/> <input type="button" value="Cancel"/>

Convert Setting > SNMP > Modbus TCP (Master) – Module Content Setting	
No.	The module number in the module list (Not editable here)
Module Name	The module name set in the module list (Not editable here)
Convert Setting > SNMP > Modbus TCP (Master) – Variable Table	
Name	Display the variable name that set in the Modbus Address Mapping Table page (Not editable here)
Attribute	Display data attribute of the variable. (Not editable) Include: Read, Read/Write...
Data Type	Display data type of the variable that set in the Modbus Address Mapping Table page. (Not editable) Include: Bool, Short, Float...
Variable OID	The variable OID code of each module I/O channel (automatically assigned by the system)
Enabled	Check [Enabled] box of the top row can enable all variables in list. Check the box of each variable can enable just that variable for conversion. Default: Uncheck.
OK	Click to save this page settings and back to the module list page.

## 5.5 Main Menu: Advanced Setting

**Advanced Setting** is the fifth (5<sup>th</sup>) item of the Main Menu, mainly to provide advanced monitoring and control related settings.

Advanced Setting provides virtual device function or cloud service function. The description is on the page of the Main Menu. It will support more functions in the future.

The items in the advanced setting functions are “PID Operation” and “IFTTT Condition Trigger”, “RESTful”, “SNMP Agent” and “Data Logger” that includes “Local Data Logger”, “MS SQL” and “MySQL / MariaDB”. This chapter will introduce the function items and setting parameters.

Advanced Setting	
<b>PID Operation</b>	The PID controller is a common feedback loop component in industrial control applications. The controller compares the collected data with a reference value and then uses this difference to calculate a new input value whose purpose is to allow the system data to reach or remain at the reference value.
<b>IFTTT Condition Trigger</b>	With the IFTTT cloud platform, the users can send messages to IFTTT-related cloud services such as Line, Twitter, etc. when the special events occur.
<b>RESTful</b>	Provide RESTful for easy access to device data.
<b>SNMP Agent</b>	Provide SNMP Agent for easy access to device data.
<b>Data Logger</b>	
<b>Local Data Logger</b>	Set local data log.
<b>MS SQL</b>	Set the MS SQL data log.
<b>MySQL / MariaDB</b>	Set the MySQL / MariaDB data log.
<b>Block List</b>	
<b>Block Rule</b>	Set the trigger condition for blocking IP connection. When the conditions are met, this function can add the IP to the blacklist and block it through the firewall.
<b>Block Status</b>	Provide the blocked IP information in the blacklist and unblock functions.

The setting for UA series controllers is to set up from the left to the right of the main menu functions. User can find the setting step and Web UI information in the following chapters.

[CH2 Quick Start 1: Hardware/Network Connection](#)

[CH3 Quick Start 2: Web UI / Setting Steps](#)

[CH4 Function Wizard: Project Quick Setup](#)

### 5.5.1 PID Operation

This page is about the virtual device function to allow users to simulate various devices with the real I/O by using the tuning function of PID operation.

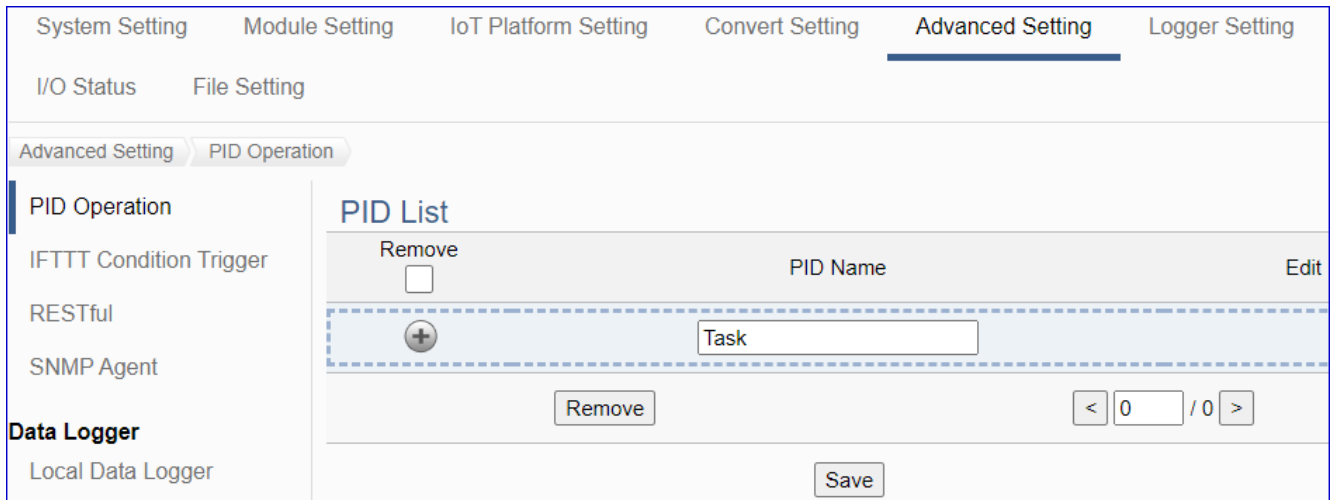

PID (Proportional-Integral-Derivative) control is the most widely used in industrial control systems. A regulator which is controlled in accordance with Proportional, Integral and Derivative is called PID control for short, also called PID regulator. When the user cannot fully grasp or measure parameters of the control system, the PID regulator is the best solution.

The PID controller is a common feedback loop component in industrial control applications. The controller compares the collected data with a reference value and then uses this difference to calculate a new input value whose purpose is to allow the system data to reach or remain at the reference value.

#### Function Diagram:

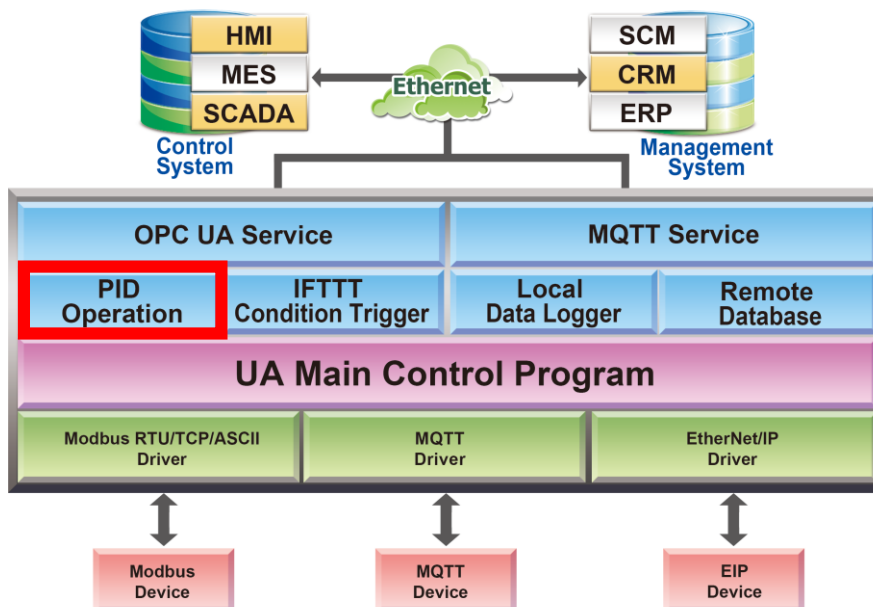

**PID Operation Solution Example:**

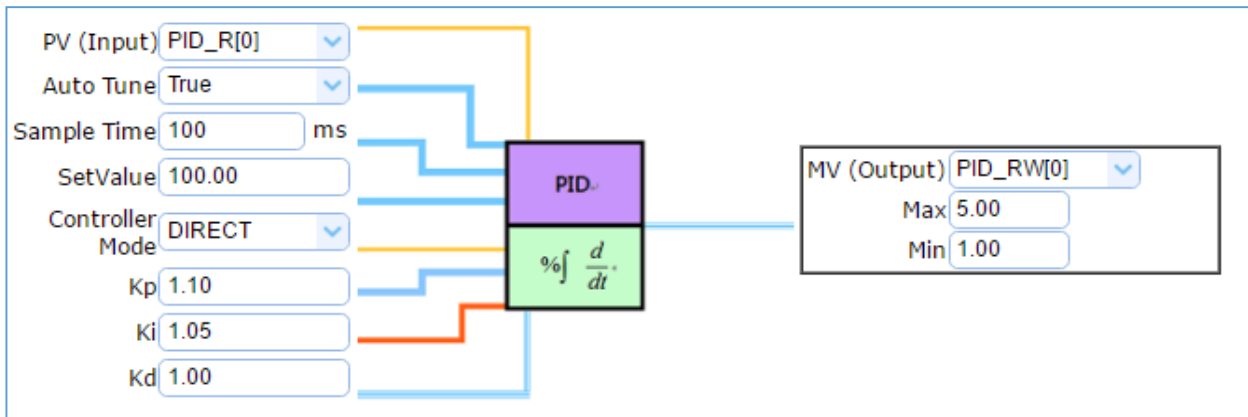

In the PID Operation function, UA controller collects the module’s data to operate via the feedback loop component of PID control. The controller compares the collected data with a reference value and then uses this difference to calculate a new input value whose purpose is to allow the system data to reach or remain at the reference value.

The setting steps of the PID Operation are as below. The descriptions for the steps setting please refer to [Section 4.4 “PID”](#) items in the Function Wizard.

**[Step Box] of [PID Operation] :**

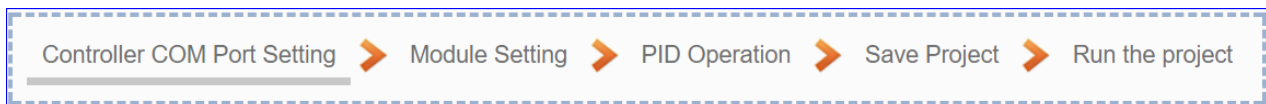

**[Step Box] of [PID Operation + OPC UA Conversion] :**

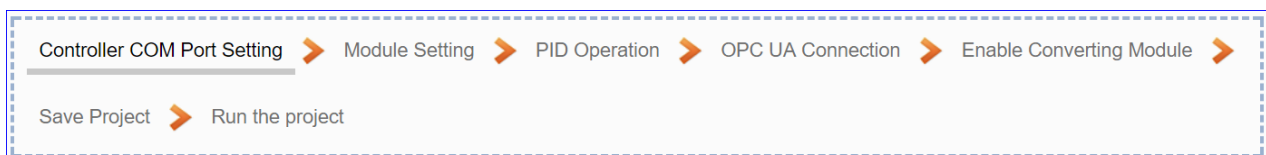

This section will introduce the function items and setting parameters of the PID Operation.

**PID List**

<input type="checkbox"/>	PID Name	Edit
<input style="border: none; background: none; width: 20px; height: 20px; border-radius: 50%;" type="button" value="+"/>	Task	
<input type="checkbox"/>	Task1	<input type="button" value="Edit"/>
<input type="button" value="Remove"/>		<input style="border: none; background: none; width: 40px; height: 20px; text-align: center; font-size: 12px; font-weight: bold; padding: 0 5px;" type="button" value="1 / 1"/> < >
<input type="button" value="Save"/>		

**Advanced Setting > PID Operation > PID List**

PID Name	PID name, user can define, e.g. Task1. Default: Task.
<input style="border: none; background: none; width: 20px; height: 20px; border-radius: 50%;" type="button" value="+"/>	Click to add a new PID Task.
Edit / Remove	Click [Edit] can set the PID content. Click the left box and [remove] can delete the PID list.
<input style="border: none; background: none; width: 40px; height: 20px; text-align: center; font-size: 12px; font-weight: bold; padding: 0 5px;" type="button" value="1 / 1"/>	The page number of the PID list: Current page / Total pages. Click < or > to go to the previous or next page.
Save	Click to save the setting of this page.

Click [Edit] botton to enter the [Content Settings] page:

**Content Settings**

PID Name	<input style="width: 90%; border: 1px solid gray;" type="text" value="Task1"/>
----------	--

**Advanced Setting > PID Operation > Content Settings**

PID Name	PID name, user can define, e.g. Task1. Default: Task.
----------	---

Input Item	
Module selection	Type : <input type="text"/> <small>Please select the module type.</small>
	No. : <input type="text"/> <small>Please select the number. When no option is available, add a module.</small>
	Name : <input type="text"/>
Variable selection	Attribute <input type="text"/> <small>Please select item.</small>
	Type : <input type="text"/> <small>Please select item.</small>
	Name : <input type="text"/> <small>Please select name. When there is no option, add the variables in the module.</small>
Auto Tune	<input checked="" type="checkbox"/> Enabled
Sample Time(ms)	<input type="text" value="500"/>
Setpoint	<input type="text" value="0"/>
Controller Mode	<input type="text" value="DIRECT"/>
Kp	<input type="text" value="1"/>
Ki	<input type="text" value="1"/>
Kd	<input type="text" value="1"/>

Advanced Setting > PID Operation > Input Item	
Module selection	Choose a predefined module for input data of the PID. Select the type, number and name of the input module. If no option is available, add a new module.
Variable selection	Choose a predefined float variable as the input parameter for PID operation. Select the attribute, type and name of the float variable.
Auto Tune	Enable: Auto-tuning PID parameters for your system. Default: check. Un-Enable: Tuning PID parameters manually, e.g. Kp, Ki, Kd.
Sample Time (ms)	Set the sampling time. (Unit: ms) Default: 500 ms.
Setpoint	The target value for PID control. Default: 0.
Controller Mode	DIRECT: Set it as positive output value. Default: DIRECT. REVERSE: Set it as reverse output value.
Kp	Set the Proportional gain. Default: 1.
Ki	Set the Integral gain. Default: 1.
Kd	Set the Derivative gain. Default: 1.

**Output Item**

Module selection	Type : <input style="width: 150px;" type="text"/>	Please select the module type.
	No. : <input style="width: 150px;" type="text"/>	Please select the number. When no option is available, add a module.
	Name : <input style="width: 150px;" type="text"/>	
Variable selection	Attribute <input style="width: 150px;" type="text"/>	Please select item.
	Type : <input style="width: 150px;" type="text"/>	Please select item.
	Name : <input style="width: 150px;" type="text"/>	Please select name. When there is no option, add the variables in the module.
Max	<input style="width: 150px;" type="text" value="0"/>	
Min	<input style="width: 150px;" type="text" value="0"/>	
<input type="button" value="OK"/> <input type="button" value="Cancel"/>		

<b>Advanced Setting &gt; PID Operation &gt; Output Item</b>	
Module selection	Choose a predefined module for output data of the PID. Select the type, number and name of the input module. If no option is available, add a new module.
Variable selection	Choose a predefined float variable as the output parameter for PID operation. Select the attribute, type and name of the float variable.
Max	Set the upper-limit value for the variable. Default: 0.
Min	Set the lower-limit value for the variable. Default: 0.
OK	Click to save the settings of the page and back to the PID list page.

**PID Operation Solution Example:**

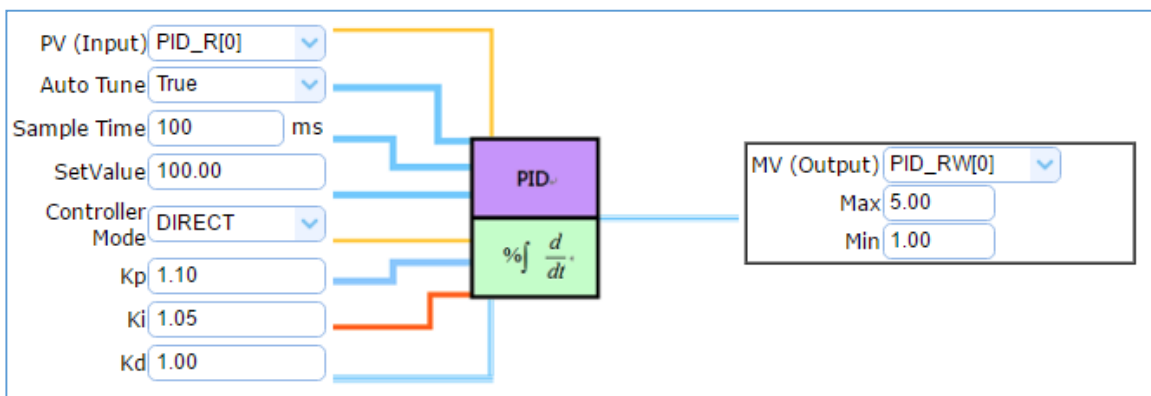

### 5.5.2 IFTTT Condition Trigger

This page is about use the IFTTT cloud platform function. Combine with the IFTTT Condition Trigger function, when the special events occur, the users can send messages to IFTTT-related cloud services (such as Line, Twitter, etc.).

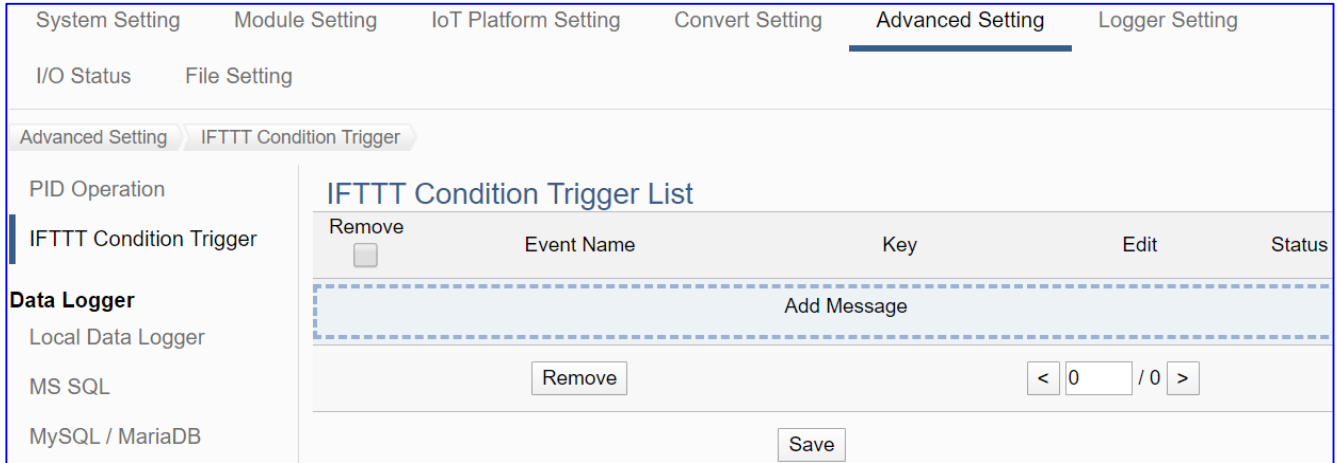

IFTTT (if this then that) is a cloud service platform that easy to get your apps and devices working together via creating chains of simple conditional statements (applets). An applet is triggered by changes that occur within other web services such as Line, Twitter, Gmail, Instagram, etc. For example, “if” Line (Service A) has a new message, “then” send an email to Gmail (Service B).

UA using the IFTTT cloud platform functions, the users can send messages to cloud services such as Line, Twitter, etc. when the special events occur.



The settings for sending the message to the APP with the "IFTTT Condition Trigger (Line, Twitter)" function includes two parts:

1. **IFTTT Cloud Platform Setting:** (Refer to [FAQ-app-1](#).)

In the IFTTT website, set up the “if” side service and event (**this**: use **webhooks** for the UA), the “then” side service and action (**that**: user can select the service, such as the Line, twitter, etc.). And then fill the “**Event Name**” and “**Key**” getting from the IFTTT website setting into the “**Content Setting**” of the UA We HMI. (Detail in the [FAQ-app-1](#) & [FAQ List](#).)



2. **UA Web Interface Setting:** ([Sec.5.5.2 Advanced Setting](#) > [IFTTT Condition Trigger](#))

In the UA Web HMI, set up the UA controller, modules, IFTTT trigger conditions, the condition variable table, and the IFTTT event connection. (Fill the **Event Name and Key** from IFTTT website into the “**Content Setting**” of the UA Web UI.)

This section introduces the setting part on the UA Web Interface, including the IFTTT trigger condition, variable table and the event message. About the setting on the IFTTT Cloud Platform, user can set up on the IFTTT website and get the “**Event Name**” and “**Key**” for the configuration here. If you are not familiar about the IFTTT, please refer to the [FAQ-app-1](#) & [FAQ List](#).

For the whole steps to send the message to an APP from setting the UA controller, module, I/O variables to the IFTTT Condition Trigger, the users can refer to the [Section 4.5](#) and the step box below.

**[Step Box : IFTTT Condition Trigger (Line, Twitter)]:**



This section will introduce the setting of the IFTTT condition trigger list, variable table and the event message.

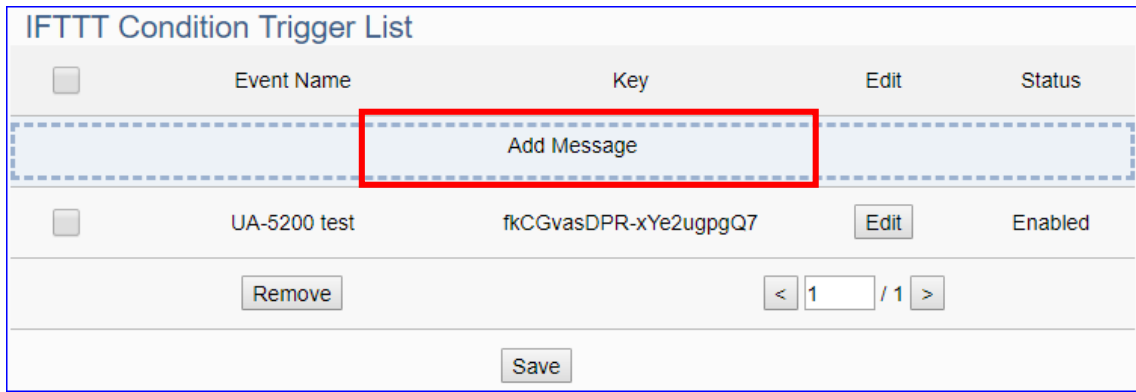

**Advanced Setting > IFTTT Condition Trigger > FTTT Condition Trigger List**

Add Message	Click to add a new IFTTT message. After setting, an IFTTT condition trigger list will show on the bottom, includes left box, event name, key and status.
<input type="checkbox"/>	Check the box in the left of the list is to select and to delete the list. Check the box on the top will select all lists.
Event Name	Display the “Event Name” setting in the IFTTT website. ( <a href="#">FAQ-app-1</a> )
Key	Display the “Key” getting from the IFTTT website. ( <a href="#">FAQ-app-1</a> )
Edit	Click [Edit] can set the IFTTT condition trigger content.
Status	Display the enable status of the IFTTT condition trigger list.
Remove	Click the left box and [remove] can delete the IFTTT list.
<input type="text" value="1"/>	The page number of the IFTTT list: Current page / Total pages. Click < or > to go to the previous or next page.
Save	Click to save the setting of this page.

Click [**Add Message**] button to enter the IFTTT [Content Settings] page:

**Content Setting**

Event Name	<input style="width: 90%;" type="text" value="UA-5200 test"/>
Key	<input style="width: 90%;" type="text" value="fkCGvasDPR-xYe2ugpgQ7"/>
Status	<input checked="" type="checkbox"/> Enabled

**Note:** The “Event Name” and “Key” are set in the IFTTT website. If you are not familiar with IFTTT, please see the [FAQ-005](#) for the setting introductions.

**Advanced Setting > IFTTT Condition Trigger > Content Setting**

Event Name	Input the “Event Name” setting in the IFTTT website. ( <a href="#">FAQ-app-1</a> )
Key	Input the “Key” getting from the IFTTT website. ( <a href="#">FAQ-app-1</a> )
Status	Check to enable the IFTTT condition trigger event.

Condition Setting		Module Variables	Operator	Value
↓ Module Type	Modbus RTU (Master) ▼			
↓ Module Name	No.1 M-7 ▼		= ▼	Type : User-Defined ▼ Dead Band : 1
↓ Variable Attribute	Read ▼			
↓ Variable Name	Tag0 (Short) ▼			
Add				

The condition setting field may different depending on the selected variable attribute.

Condition Setting		Module Variables	Status
↓ Module Type	Modbus RTU (Master) ▼		
↓ Module Name	No.2 M-7055D ▼		Status Change ▼
↓ Variable Attribute	Read ▼		
↓ Variable Name	Tag0 (Bool) ▼		

Advanced Setting > IFTTT Condition Trigger > Condition Setting	
Module Variables	Select the module and variable for the condition trigger. Module Type: select the module type, Modbus RTU/TCP/ASCII... Module Name: select the module that set for condition trigger. Variable Attribute: select the variable attribute for condition trigger. Variable Name: select the variable name for condition trigger.
The following condition fields may different depending on the selected variable attribute. The condition trigger method will be described after this table.	
Operator	Select the operator for the trigger condition.
Value	Set up the value for the condition, include Type and Dead Band.
Status	Set up the status for the condition. Default: 0.
Add	Click to add a condition trigger list in the Condition Table..

## Condition Trigger Descriptions:

The condition trigger method will differ depending on the attribute of the selected variable and the trigger will be different. There are two operation styles: **DIO** and **AIO**.

**(A)** If select **DIO variable**, then Condition is "Status Change". When detecting the status is changed, it will trigger the event and send the assigned message. (Below is a switch detecting example.)

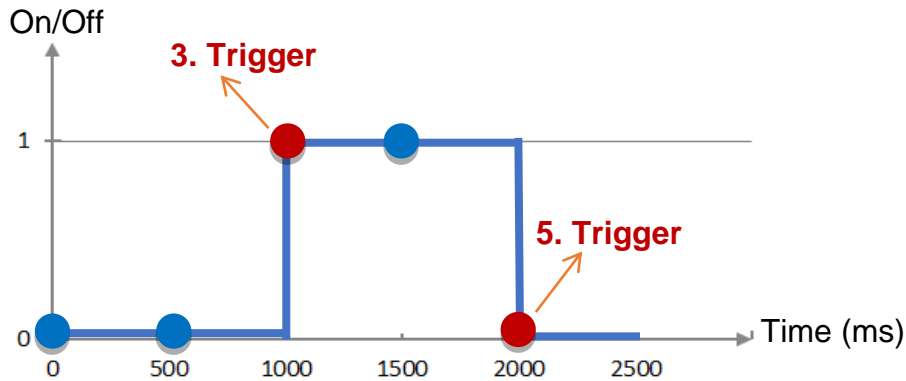

**DIO Trigger:** (Detect per 500 ms)

1. Detect initial switch status "Off" (status = 0)
2. Detect "Off" (status = 0, status no change), no trigger
3. Detect "On" (status = 1, status changed), trigger a message notification
4. Detect "On" (status = 1, status no change), no trigger
5. Detect "Off" (status = 0, status changed), trigger a message notification

(B) If select **AIO variable**, then Condition is “Value” and can set the “Dead Band”. The condition will be triggered and send the message when the detected value exceeds the upper or lower Dead Band. (Below is a CO2 example. Detect per 500 ms)

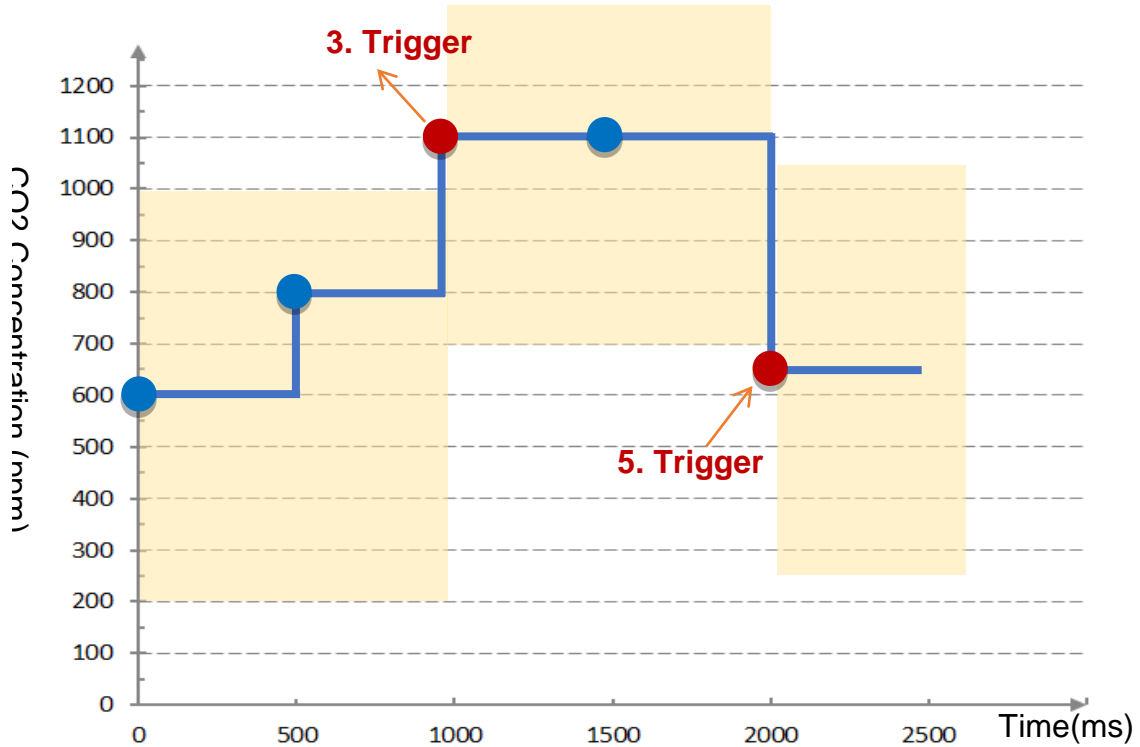

**AIO Trigger:** (Detect per 500 ms. The yellow block means the Dead Band.)

1. Detect initial CO2 concentration 600 (ppm).  
Set Dead Band=400 (Initial Trigger Condition:  $\geq 1000$  or  $\leq 200$ )
2. Detect CO2 concentration 800. It is in the range of Dead Band.
3. Detect CO2 concentration 1100. It exceeds the upper value ( $\geq 1000$ ) of Dead Band, so trigger a message for danger notification.
4. Detect CO2 concentration 1100. It is in the new range of Dead Band.  
Dead Band=400 (New Trigger Condition:  $\geq 1500$  or  $\leq 700$ )
5. Detect CO2 concentration 650. It is below the lower value ( $\leq 700$ ) of Dead Band, so trigger a message for safety notification.

Please refer to the previous Condition Trigger Descriptions to set up your Condition. When complete, click the “Add” button. The setting will show in the Condition Table. Below Table is setting 2 conditions.

Advanced Setting > IFTTT Condition Trigger > Condition Table	
Module	Display the module type and name of the condition. (Not editable here)
Variable	Display the variable attribute and name of the condition. (Not editable here)
Condition	Display the trigger condition. (Not editable here)
Define Message	Default Message: module code variable code. The user can define own message in the format of English character, number, general symbol...
Remove	Click the left box and [remove] can delete the IFTTT list.
OK	Click to save this page settings and back to the module list page.
Cancel	Click to exit without saving and back to the module list page.

When back to the IFTTT Condition Trigger List, the condition trigger message will show as below picture. If need more trigger conditions, click the “Add Message” again to combine the IFTTT APP message sending and the UA system. At last, click the Save button.

### 5.5.3 RESTful

This function is mainly to enable the RESTful API web service function in the REST design format. Via a web browser, users can obtain device information. It is an advanced function only **available in the UA-2800 series. UA-5200/2200 series is not supported.**

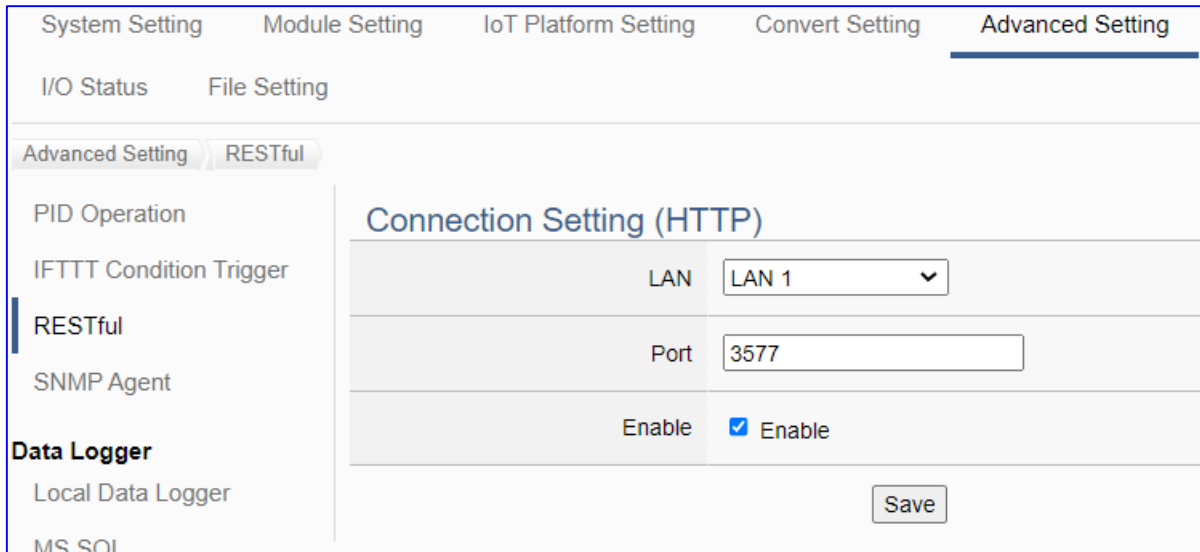

**REST** (Representational state transfer) is a software architectural style that was created to guide the design and development of the architecture for the World Wide Web. REST is a widely accepted set of guidelines for creating stateless, reliable web APIs. A web API that obeys the REST constraints is informally described as **RESTful**. **RESTful** web APIs are typically loosely based on HTTP methods to access resources via URL-encoded parameters and transmit data.

UA series of ICP DAS provides RESTful web services to read and write I/O variables of the connection module.

#### Function Diagram:

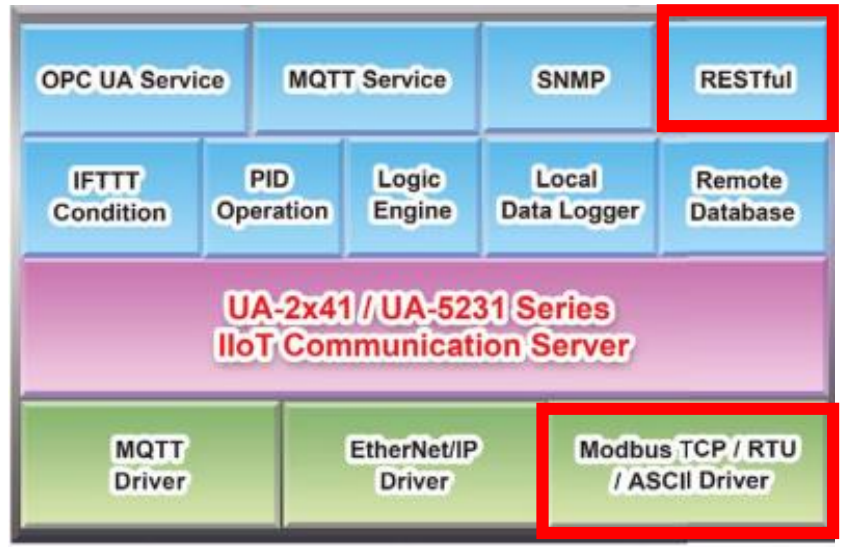

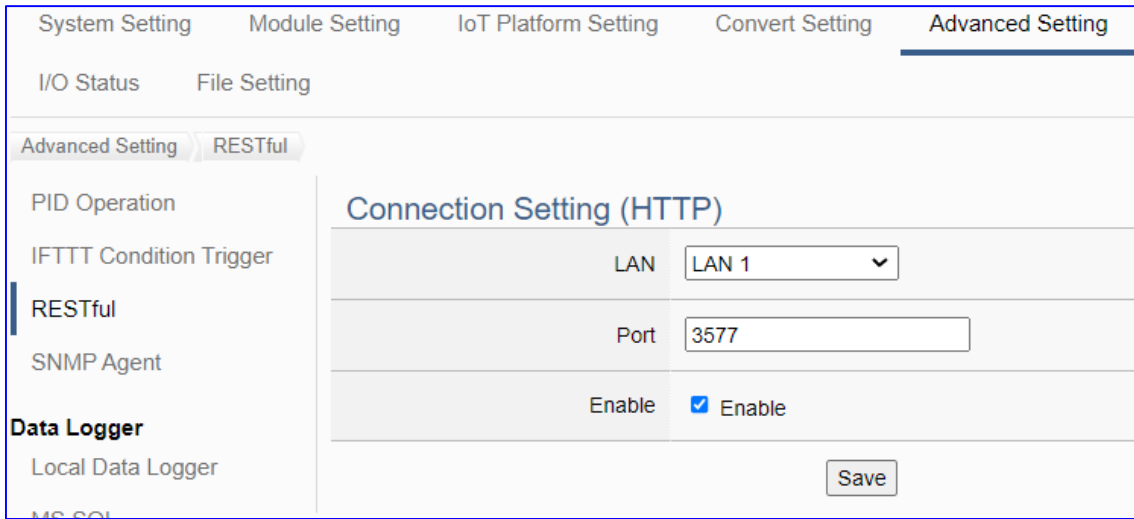

Advanced Setting > RESTful > Connection Setting (HTTP)	
LAN	Choose LAN1 or LAN2, mainly choose to use the IP address of LAN1 or LAN2.
Port	RESTful connection port, Default: 3577 (the RESTful default port)
Enable	Enable: Check the box and click Save to enable the RESTful function.
Save	Click the Save button to save the settings on this page.

**[RESTful usage table]** Enter "IP address: port/request method" in the address bar of the web browser.

HTTP Method	Path Command	Description
GET	/AllVariableName	Read all variable data.
	/VariableInformation?var0,var1, var2...	Read the data of var0, var1, var2... in all variables, data are separated by commas.
PUT	/VariableInformation	writes the variable data being used.

**[JSON Content Description]**

JSON Content	Item	Description
<pre>{   "Var1": {     "Quality": "Good",     "Value": "24.5"   },   "Var2": {     "Quality": "Good",     "Value": "24.5"   } }</pre>	Quality	The communication quality of the variable. Return Item: Good, Uncertain, Bad.
	Value	Return the value of the variable.

**[RESTful Example]:**

- Requirements: The user needs to obtain the I/O variable data of all modules connected to the UA-2800 in a web browser.

**1. Setting Steps:**

Click on the UA web interface **[Advanced Settings]** > **[RESTful]** Settings:

Select LAN1 (in this example, the IP of LAN1 is **192.168.84.80**), check the **Enable** box, and click **Save**.

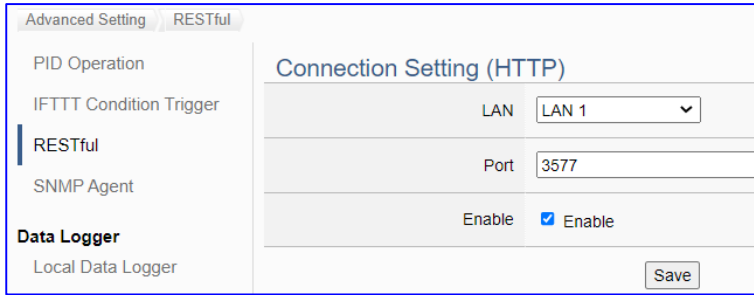

**2. Using Steps:**

Open a web browser, e.g. Chrome, and then enter "IP:Port" and the requested command in the address bar.

**[This Example]** The user wants to "get" variable data, so use the **"GET"** command **"/AllVariableName"**. Please enter **"192.168.84.80:3577/AllVariableName"** to get the data for all I/O variables of the connected module.

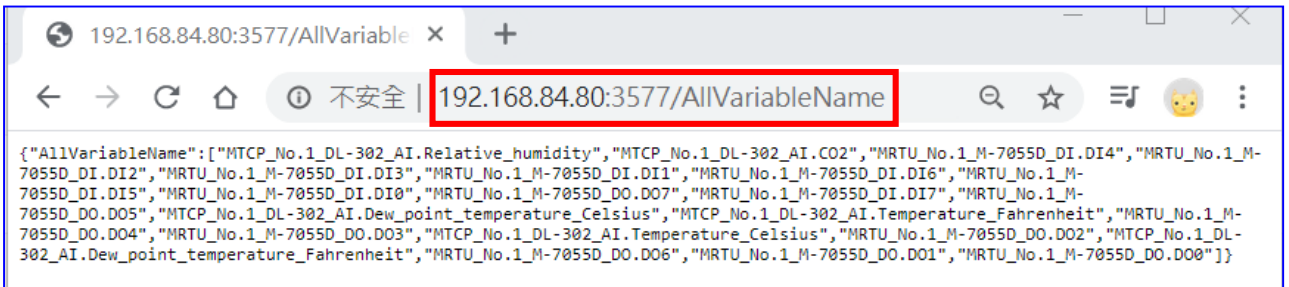

From the upper web browser and the lower UA web interface, the user can find that UA supports directly request all the I/O variable data of the connected modules DL-302 and M-7055D via the web browser.

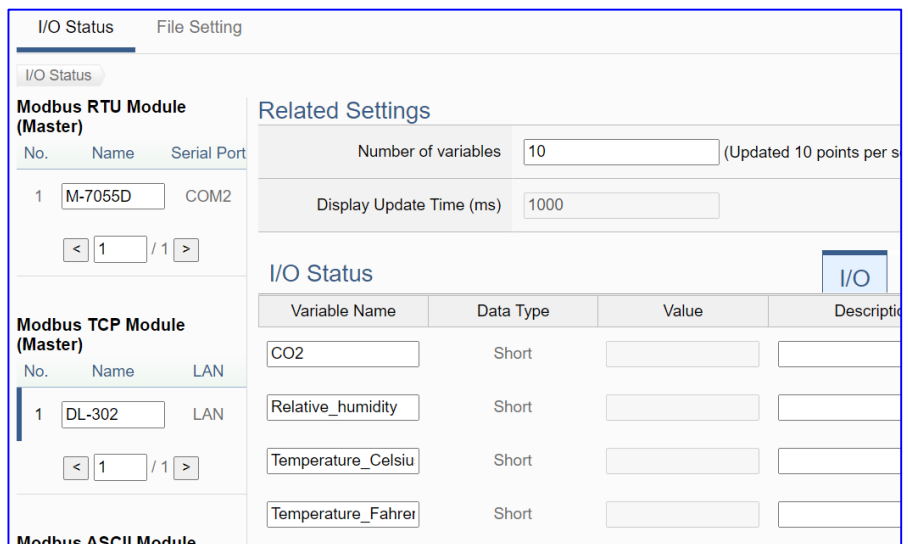

### 5.5.4 SNMP Agent

This function is mainly to set up SNMP connection encryption and device management. It provides SNMP Agent to facilitate the acquisition of device information. It is an advanced function only **available in the UA-2800 series. UA-5200/2200 series is not supported.**

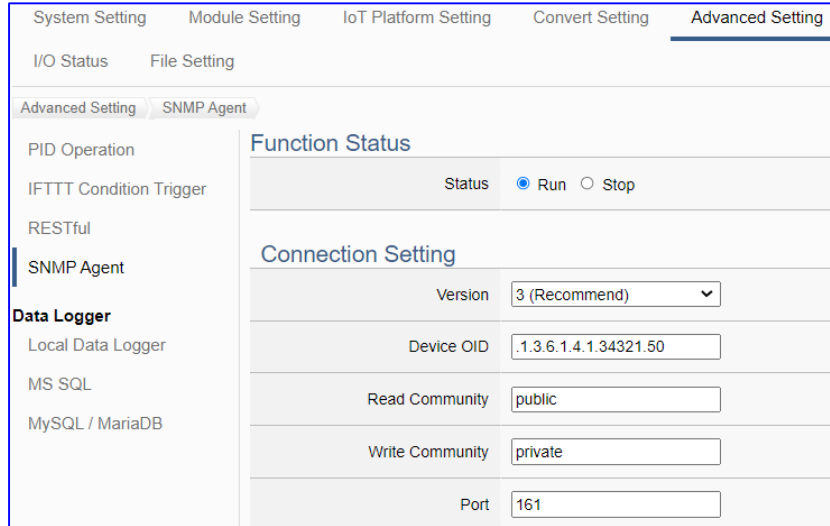

SNMP (Simple Network Management Protocol) is a communication protocol for managing network devices. It is one of the widely accepted communication protocols for managing and monitoring network elements. The user can use it in wireless networks to detect malicious wireless base stations. Network managers can isolate and dispose of them in real-time based on the detection results to avoid leakage of internal information or deliberate external attacks to maintain information security.

SNMP Agent presents the relevant information of the managed device in the form of variables. Each variable has its unique Object Identifier (OID), and the OID hierarchically describes in the Management Information Base (MIB). For example, the OID of the UA device is ".1.3.6.1.4.1.34321.50".

**Function Diagram:**

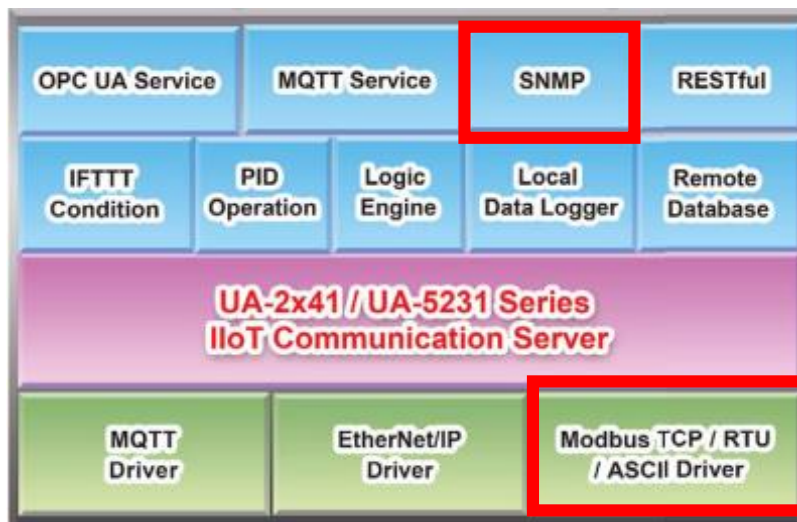

Function Status	
Status	<input checked="" type="radio"/> Run <input type="radio"/> Stop
Connection Setting	
Version	3 (Recommend) ▼
Device OID	.1.3.6.1.4.1.34321.50
Read Community	public
Write Community	private
Port	161
USM User	icpdas
Auth Algorithm	MD5 ▼
Auth Password	.....
Privacy Algorithm	DES ▼
Privacy Password	.....
SNMP Agent	<input checked="" type="checkbox"/> Run at startup
Save	

Advanced Setting > SNMP Agent > Function Status	
Status	Click to start or stop the SNMP Agent connection service immediately.
Advanced Setting > SNMP Agent > Connection Setting	
Version	SNMP currently has versions: v1, v2, v3 <b>v1</b> and <b>v2</b> provide basic read/write MIB functions. <b>v3</b> provides encrypted data transmission and user authentication technology.
Device OID	Object identifier of the device, automatically generated by the system
Read Community	Set the community string for read-only access
Write Community	Set the community string for read and write access permissions
Port	SNMP connection port. Default: 161
USM User	Set the user name of the User-based Security Model, which can be alphanumeric (case-sensitive), with no space, and within 32 characters.
Auth Algorithm	Set the user authorization algorithm to encrypt and protect the password
Auth Password	Set user authentication password, at least 8 and within 32 characters.
Privacy Algorithm	Set encryption type, encrypt and protect privacy password
Privacy Password	Set user privacy password, at least 8 and within 32 characters.
SNMP Agent	Run at startup: Check box to run the SNMP Agent at startup.
Save	Click the Save button to save the settings on this page.

### 5.5.5 Data Logger: Local Data Logger

UA's Local Data Logger function can automatically record the I/O status at setting intervals and save them in a CSV file on the local microSD card.

This function is for setting the local data logger and the microSD card. For the setting about the logger and module, please refer to [Chapter 5.6](#).

When the local data logger function is running, the system will allocate memory as a read/write file cache temporarily. When the function runs for a long time, it will increase the memory resource utilization. This situation is normal and does not affect the long-term stability of UA operation.

#### Function Diagram:

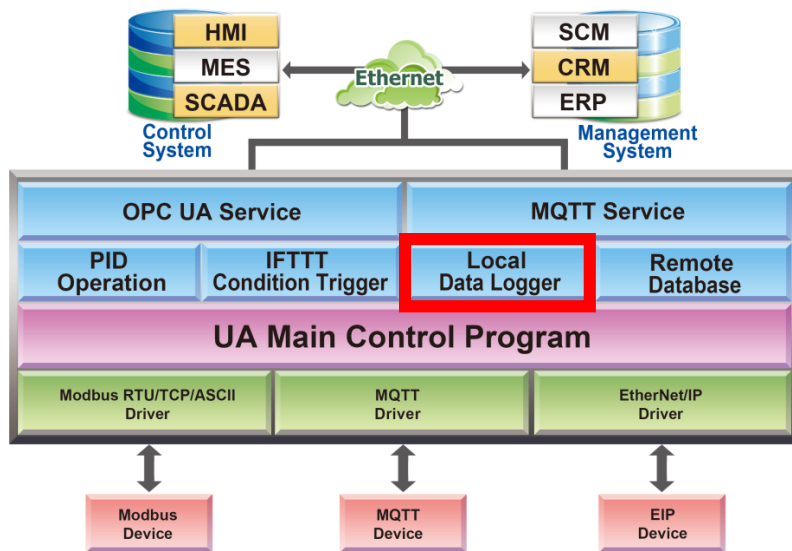

#### Application:

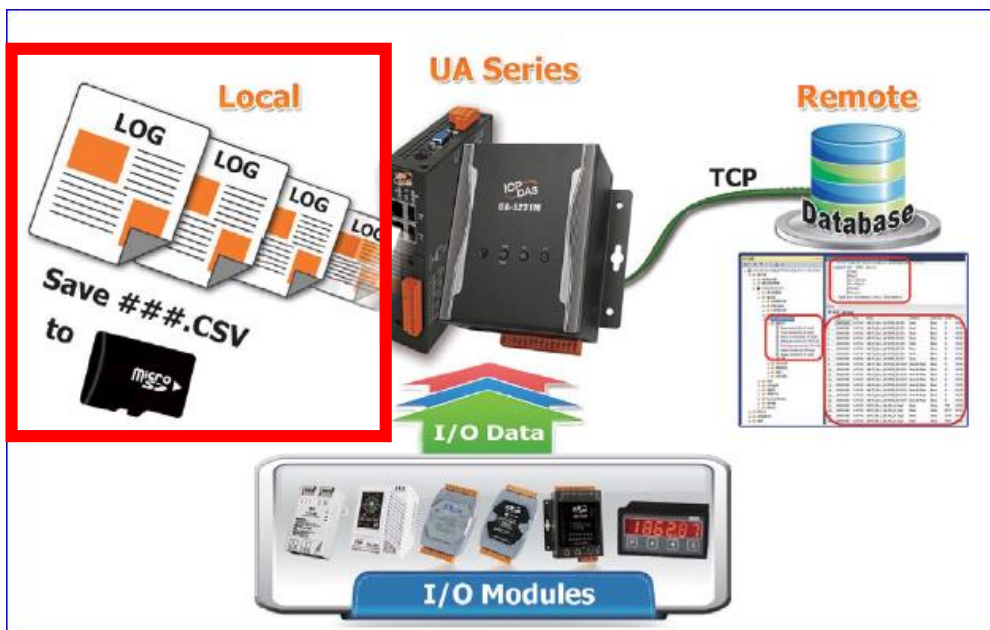

Enter the main menu [Advanced Setting] > [Data Logger] > [Local Data Logger]:

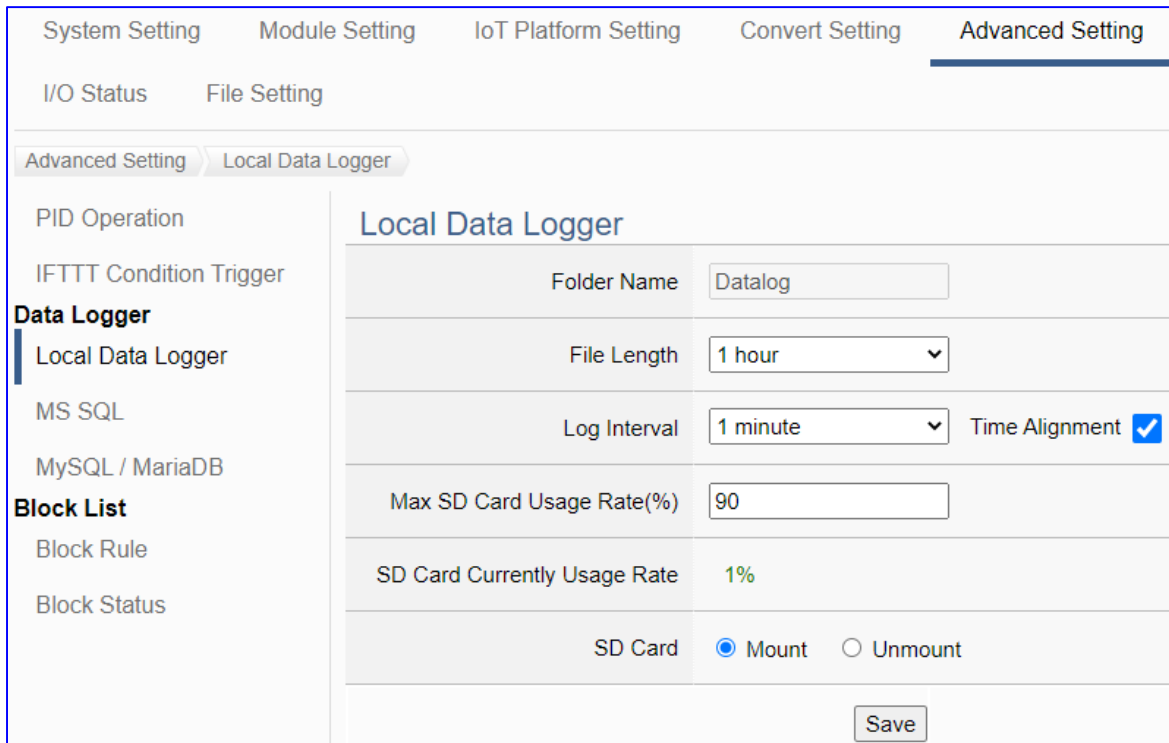

Advanced Setting > Data Logger > Local Data Logger	
Folder Name	The folder name in microSD card of UA, user definable. The I/O data will save into the file “log.csv” under this folder.
File Length	Unit: hour. User can select per 1, 2, 3, ... 8, 12, or 24 hours to divide the log.csv into the file “log-Y-M-D-H-M-S.csv” under the folder “Y-M”. (e.g. 2018-12)
Log Interval	The interval to save I/O data per seconds, minutes or hours.
Time Alignment	Align records time at selected log intervals (default: unchecked). When enabling the Time Alignment, it will record the first log at the beginning time. And will align other log times with multiples of the log interval (seconds, minutes, hours). For example, if the log interval is 5 seconds, the first log time is 13:01:04, and the following log records will be 13:01:05, 13:01:10, etc., the seconds being multiples of 5 seconds.
Max SD Card Usage Rate (%)	Set up the maximum usage rate (Unit: %) of UA microSD card. If the data current rate meet the max rate, the oldest data will be removed first.
SD Card Currently Usage Rate	Display the current usage rate of UA microSD card (show %).
SD Card	Mount: Click to mount microSD card and begin to record data. Unmount: Click to unmount microSD card and stop record data.
Save	Click to save the settings of this item.

● **CVS local data log file: fields and example**

1. The Log record will be stored to the microSD card in the UA PAC, and the default name is the **folder "Datalog"** which can be customized by the user.
2. I/O data records will be stored in the **file "log.csv"** under this folder.
3. The log data file is divided every 1, 2, 3... 8, 12 or 24 hours according to user settings, and saved under the **folder "YYYY-MM"**.
4. Save to the **file "log-YYYY-MM-DD-HH-MM-SS.csv"**. Each tag data and status are recorded in each separate row, **the row is added down for each interval**, and the tag data is recorded in time sequence.

**[ EX ] Folder Name: [Datalog] ①**  
**Save I/O data per 10 sec to the file [log.csv]. ②**  
**Divide file per 1 hr to the folder of [Y-M-folder] ③**  
**into the file [log-Y-M-D-H-M-S.csv] ④**

The screenshot shows the 'Local Data Logger' configuration page. The 'Folder Name' is set to 'Datalog', 'File Length' is '1 hour', and 'Log Interval' is '10 seconds'. Callouts 1-4 point to the folder name, the 'log.csv' file, the '2020-12' folder, and a specific log file 'log-2020-12-19-16-03-27.csv' respectively.

	A	B	C	D
1	# Log file created/rotated Thursday	29 Oct 20 05:50:10 GMT		
2	Timestamp	Name	Value	Status
3	2020-10-29-13-50-10	MRTU_No.1_tM-AD4P2C2_AO.Vin0	11979	Good
4	2020-10-29-13-50-10	MRTU_No.1_tM-AD4P2C2_AO.Vin1	5495	Good
5	2020-10-29-13-50-10	MRTU_No.2_DL-302_AO.CO2	736	Good
6	2020-10-29-13-50-10	MRTU_No.2_DL-302_AO.RH	6371	Good
7	2020-10-29-13-50-10	MRTU_No.2_DL-302_AO.TC	2694	Good
8	2020-10-29-13-50-10	MRTU_No.2_DL-302_AO.TF	8049	Good
9	2020-10-29-13-50-10	MRTU_No.2_DL-302_AO.DC	1947	Good
10	2020-10-29-13-50-10	MRTU_No.2_DL-302_AO.DF	6704	Good
11	2020-10-29-13-50-20	MRTU_No.1_tM-AD4P2C2_AO.Vin0	11979	Good
12	2020-10-29-13-50-20	MRTU_No.1_tM-AD4P2C2_AO.Vin1	5771	Good
13	2020-10-29-13-50-20	MRTU_No.2_DL-302_AO.CO2	734	Good
14	2020-10-29-13-50-20	MRTU_No.2_DL-302_AO.RH	6370	Good
15	2020-10-29-13-50-20	MRTU_No.2_DL-302_AO.TC	2694	Good
16	2020-10-29-13-50-20	MRTU_No.2_DL-302_AO.TF	8049	Good
17	2020-10-29-13-50-20	MRTU_No.2_DL-302_AO.DC	1947	Good
18	2020-10-29-13-50-20	MRTU_No.2_DL-302_AO.DF	6704	Good
19	2020-10-29-13-50-30	MRTU_No.1_tM-AD4P2C2_AO.Vin0	11979	Good

log-2020-10-29-13-51-20

### 5.5.6 Data Logger: MS SQL

UA's: MS SQL data logger function can automatically record I/O status at setting intervals, and write the data directly to remote MS SQL databases.

This function is for setting the remote database connection. For the setting about the logger and module, please refer to [Chapter 5.6](#).

#### Function Diagram:

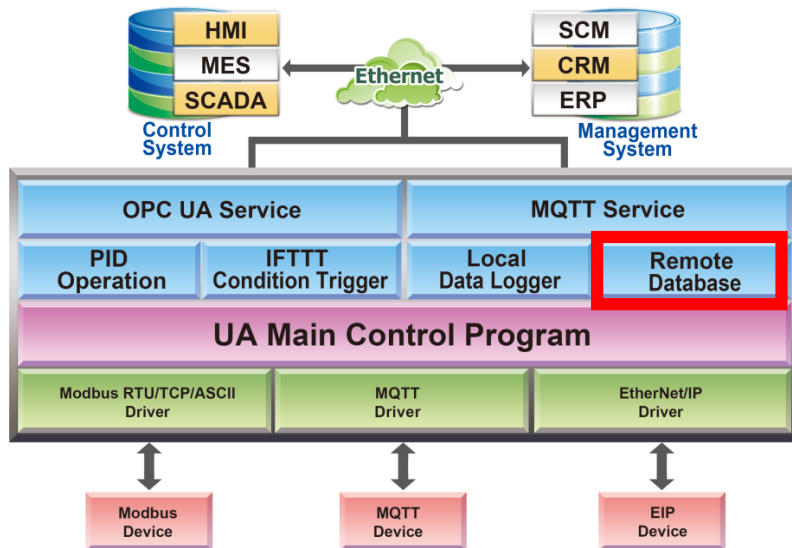

#### Application:

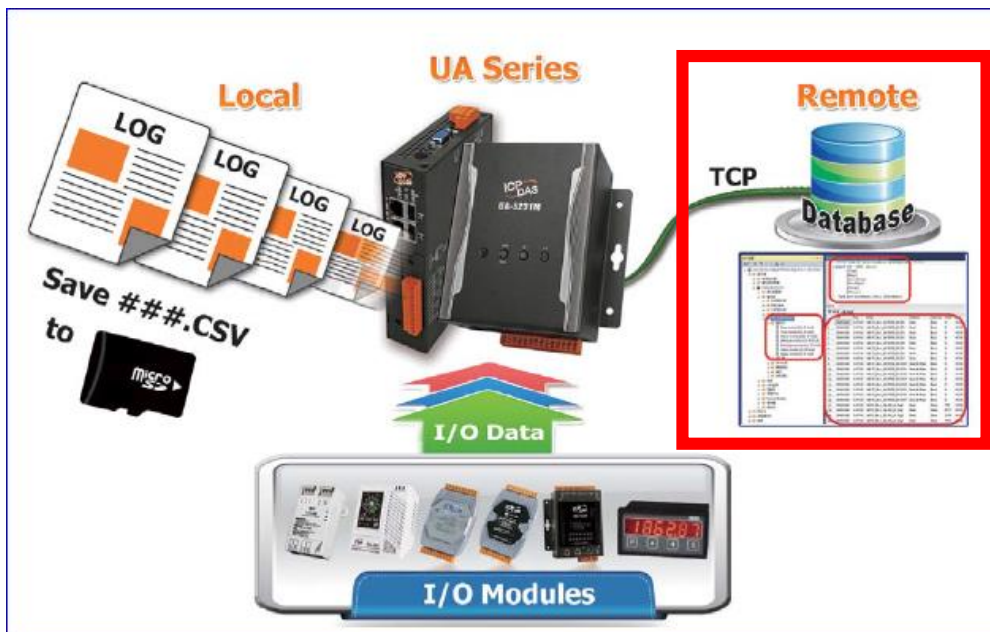

Enter the main menu [Advanced Setting] > [Data Logger] > [MS SQL] screen, enter a Name (e.g. "ICPDAS\_Cycle\_DateTime"), and click the plus sign to add a MS SQL remote database list as below.

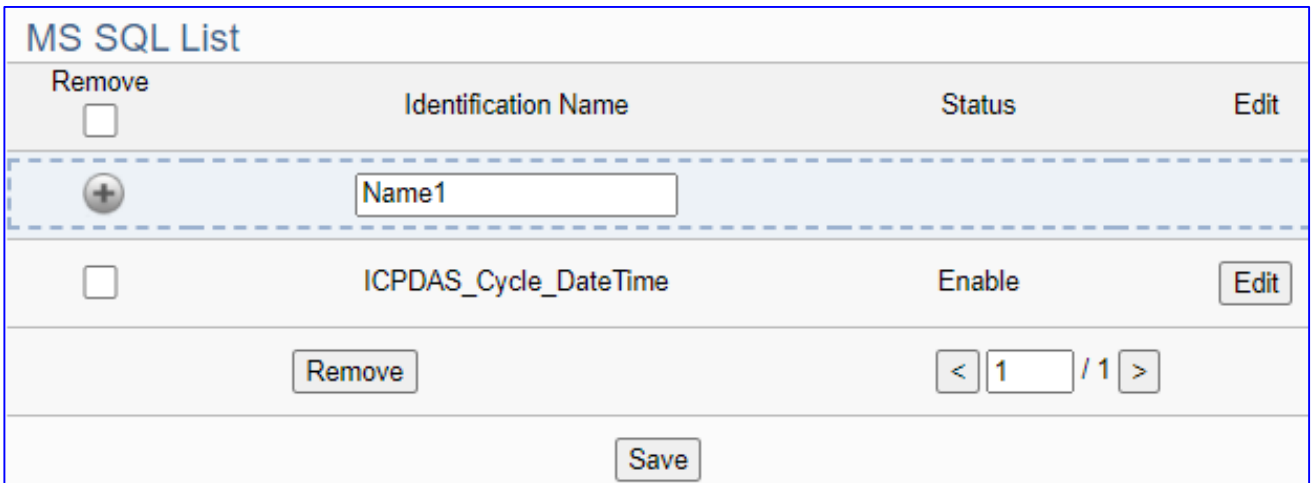
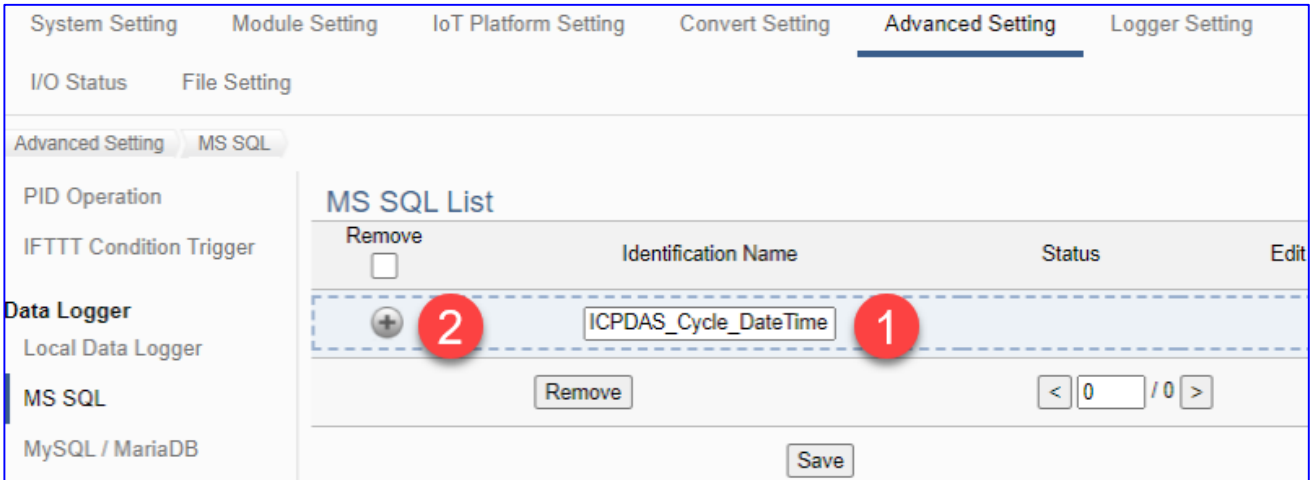

Advanced Setting > Data Logger > MS SQL List	
<input type="checkbox"/> Remove	Check Remove box to remove all database connection in list. Check the box of each database and click the "Remove" button can remove just that database connection.
Identification Name	User defined name to identify the remote database. Default: Name.
Status	Display the status (Enable/Disable) of the database connection. Default: Enable.
<input type="button" value="+"/> +	Click to add a new remote database connection.
Edit	Click to enter the "Content Setting" page of the remote database.
<input type="button" value="&lt; 1 / 1 &gt;"/>	The page number of the database list: Current page / Total pages. Click < or > to go to the previous or next page.
Save	Click to save the settings of this page.

Click "Edit" to enter the "MS SQL connect settings" page.

MS SQL content settings	
Identification Name	<input type="text" value="MSSQL"/>
Database Name	<input type="text" value="test"/>
Table Name	<input type="text" value="TableName"/>
Server Name	<input type="text" value="192.168.1.76\SQLEXPRESS"/>
Port	<input type="text" value="1433"/>
Account	<input type="text" value="test"/>
Password	<input type="password" value="...."/>
Log Mode	<input type="text" value="Cycle-Time Alignment"/>
Interval Seconds	<input type="text" value="5 seconds"/>
Date Time Format	<input type="text" value="[yyyy-MM-dd], [HH:mm:ss]"/>
Offline Data Recovery	<input type="checkbox"/>
Enable	<input checked="" type="checkbox"/>
Test Connection	<input type="button" value="Connection"/>
<input type="button" value="OK"/> <input type="button" value="Cancel"/>	

Advanced Setting > Data Logger > MS SQL – Content Setting	
Identification Name	User defined name to identify the database.
Database Name	The name of the remote database. If not exist, It will create one.
Table Name	The table name of the remote DB. If not exist, It will create one.
Server Name	The Server IP and name of the remote database.
Port	The port to link with database. Default: 1433 (for MS SQL)
Account	The login name of the remote database.
Password	The login password of the remote database.
Log Mode	<p><b>Cycle:</b> Record one log data at the interval time (set below).</p> <p><b>Cycle-Time Alignment:</b> Cycle mode with <b>Time Alignment</b>. Time Alignment is to align records time at the selected interval. It will record the first log at the beginning time. And will align other log times with multiples of the log interval (seconds, minutes, hours). For example, if the log interval is 5 seconds, the first log time is 13:01:04, and the following log records will be 13:01:05, 13:01:10, etc., the seconds being multiples of 5 seconds.</p> <p><b>Data Change:</b> Only record when the data has changed.</p>
Interval Seconds	Set up the interval time to save the I/O data to the remote database. Unit: Second.
Date Time Format	Select to separate the date and time into two [Columns] or combine the date and time in one [Column].

Advanced Setting > Data Logger > MS SQL – Content Setting	
Offline Data Recovery (Note 1)	Check to enable the Offline Data Recovery (Note 1). If the database is offline, UA will temporarily store the data in the SD card. When the connection is online, UA will retrieve the data from the SD card and re-sent it to the database. (Default: unchecked)
Enable	Enable the data logger to the remote database. Default: check.
Test Connection	Click to test the connection to the remote database. Result: Success or Failure.
OK / Cancel	Click “OK” to save the settings of this page. Click “Cancel” to exit the setting page without saving.

**Note 1.**

**Offline Data Recovery Mechanism**

For general data collection, the sensor data will be sent to the control center and imported into the Database at cloud. But when the network experience a disconnection, the data transmitted during the offline period will be lost. UA Series supports the Offline Data Recovery mechanism. When experiences network disconnection, all data will be stored in the SD cards in UA Series. And when the network return to normal status, the data stored in SD card will be re-sent to UA, and imported into Database to ensure the integrity of historical data.

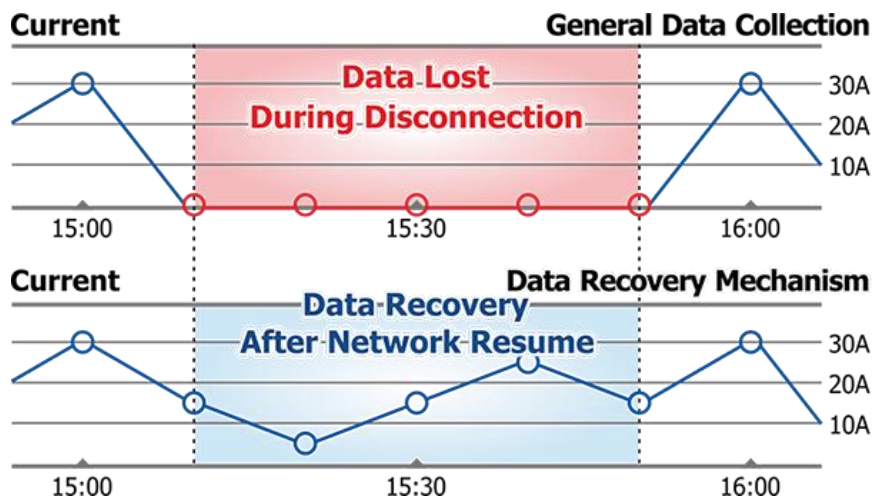

When offline occurs, the data storage capacity of the 4GB SD card and the time to write data back to SQL after online again:

1000 Tags Log Interval	Data amount for offline 1 hr.	Time to write data to SQL after offline 1 hr.	Time capacity of 4 GB SD card
10 Seconds	22.4 MB	28 Minutes	5.5 Days (132 Hours)
30 Seconds	7.47 MB	9.34 Minutes	16.5 Days (396 Hours)
1 Minute	3.73 MB	4.67 Minutes	33 Days (732 Hours)
5 Minutes	0.47 MB	0.94 Minutes	165 Days (3960 Hours)

● **MS SQL Remote Database Example Descriptions:**

Each tag data and status are recorded in each separate row, **the row is added down for each interval**, and the tag data is recorded in time sequence.

For database operation, please refer to **FAQ-Dev-001** of the **UA series FAQ list**:

**FAQ-Dev-001** How to save the UA collected data into SQL and then show trend chart in InduSoft? (Take MS SQL 2017 Express as an example)

The connection screen view of the MS SQL Remote Database.

**1. MS SQL database screen view: Date/Time column separated**

The screenshot displays the SQL Server interface. On the left is the Object Explorer showing the server structure. The main window shows a query window with the following SQL code:

```

/***** Script for SelectTopNRows command from SSMS *****/
SELECT TOP (1000) [Date]
, [Time]
, [Name]
, [Attribute]
, [DataType]
, [Value]
, [Status]
FROM [DatabaseName].[dbo].[TableName]
    
```

Below the query window, the Results pane shows a table with 16 rows of data. The columns are Date, Time, Name, Attribute, DataType, Value, and Status.

	Date	Time	Name	Attribute	DataType	Value	Status
1	2020-10-29	17:55:54	MRTU_No.1_IM-AD4P2C2_AO.VinU	Read & Write	Short	11979	GOOD
2	2020-10-29	17:55:54	MRTU_No.1_IM-AD4P2C2_AO.Vin1	Read & Write	Short	6155	GOOD
3	2020-10-29	17:55:54	MRTU_No.2_DL-302_AO.CO2	Read & Write	Short	694	GOOD
4	2020-10-29	17:55:54	MRTU_No.2_DL-302_AO.RH	Read & Write	Short	6351	GOOD
5	2020-10-29	17:55:54	MRTU_No.2_DL-302_AO.TC	Read & Write	Short	2650	GOOD
6	2020-10-29	17:55:54	MRTU_No.2_DL-302_AO.TF	Read & Write	Short	7970	GOOD
7	2020-10-29	17:55:54	MRTU_No.2_DL-302_AO.DC	Read & Write	Short	1901	GOOD
8	2020-10-29	17:55:54	MRTU_No.2_DL-302_AO.DF	Read & Write	Short	6621	GOOD
9	2020-10-29	17:55:59	MRTU_No.1_IM-AD4P2C2_AO.Vin0	Read & Write	Short	11980	GOOD
10	2020-10-29	17:55:59	MRTU_No.1_IM-AD4P2C2_AO.Vin1	Read & Write	Short	6002	GOOD
11	2020-10-29	17:55:59	MRTU_No.2_DL-302_AO.CO2	Read & Write	Short	693	GOOD
12	2020-10-29	17:55:59	MRTU_No.2_DL-302_AO.RH	Read & Write	Short	6353	GOOD
13	2020-10-29	17:55:59	MRTU_No.2_DL-302_AO.TC	Read & Write	Short	2650	GOOD
14	2020-10-29	17:55:59	MRTU_No.2_DL-302_AO.TF	Read & Write	Short	7970	GOOD
15	2020-10-29	17:55:59	MRTU_No.2_DL-302_AO.DC	Read & Write	Short	1901	GOOD
16	2020-10-29	17:55:59	MRTU_No.2_DL-302_AO.DF	Read & Write	Short	6621	GOOD

## 2. MS SQL database screen view: Date/Time column combined

The screenshot displays the Microsoft SQL Server Enterprise Manager interface. On the left, the Object Explorer shows the server structure for '192.168.81.5\SQLEXPRESS (SQL S...)', including Databases, System Databases, Database Snapshots, DatabaseName, Database Diagrams, Tables, Views, External Resources, Synonyms, Programmability, Service Broker, Storage, Security, Server Objects, Replication, and PolyBase.

The central window shows a SQL query window titled 'SQLQuery2.sql - 1...CPDAS (chris (56))\*'. The query is as follows:

```

/***** Script for SelectTopNRows command from SSMS *****/
SELECT TOP (1000) [DateTime]
, [Name]
, [Attribute]
, [DataType]
, [Value]
, [Status]
FROM [ICPDAS].[dbo].[Module_All_DateTime]
    
```

Below the query window, the Results pane shows the output of the query. The results are displayed in a table with the following columns: Date/Time, Name, Attribute, DataType, Value, and Status. The data is sorted by Date/Time.

	Date/Time	Name	Attribute	DataType	Value	Status
1	2020-10-29 10:12:21	MRIU_No.1_0M-AD4F2C2_AO.Vin0	Read & Write	Short	11979	GOOD
2	2020-10-29 10:12:21	MRIU_No.1_0M-AD4F2C2_AO.Vin1	Read & Write	Short	5042	GOOD
3	2020-10-29 10:12:21	MRIU_No.2_DL-302_AO.CO0	Read & Write	Short	662	GOOD
4	2020-10-29 10:12:21	MRIU_No.2_DL-302_AO.RH	Read & Write	Short	6627	GOOD
5	2020-10-29 10:12:21	MRIU_No.2_DL-302_AO.TC	Read & Write	Short	2659	GOOD
6	2020-10-29 10:12:21	MRIU_No.2_DL-302_AO.TF	Read & Write	Short	7926	GOOD
7	2020-10-29 10:12:21	MRIU_No.2_DL-302_AO.DC	Read & Write	Short	1977	GOOD
8	2020-10-29 10:12:21	MRIU_No.2_DL-302_AO.DF	Read & Write	Short	6750	GOOD
9	2020-10-29 10:12:26	MRIU_No.1_0M-AD4F2C2_AO.Vin0	Read & Write	Short	11979	GOOD
10	2020-10-29 10:12:26	MRIU_No.1_0M-AD4F2C2_AO.Vin1	Read & Write	Short	5169	GOOD
11	2020-10-29 10:12:26	MRIU_No.2_DL-302_AO.CO0	Read & Write	Short	662	GOOD
12	2020-10-29 10:12:26	MRIU_No.2_DL-302_AO.RH	Read & Write	Short	6627	GOOD
13	2020-10-29 10:12:26	MRIU_No.2_DL-302_AO.TC	Read & Write	Short	2650	GOOD
14	2020-10-29 10:12:26	MRIU_No.2_DL-302_AO.TF	Read & Write	Short	7924	GOOD
15	2020-10-29 10:12:26	MRIU_No.2_DL-302_AO.DC	Read & Write	Short	1977	GOOD
16	2020-10-29 10:12:26	MRIU_No.2_DL-302_AO.DF	Read & Write	Short	6750	GOOD

### 5.5.7 Data Logger: MySQL / MariaDB

UA's: MySQL / MariaDB data logger function can automatically record I/O status at setting intervals, and write the data directly to remote MySQL and MariaDB databases.

This function is for setting the remote database connection. For the setting about the logger and module, please refer to [Chapter 5.6](#).

#### Function Diagram:

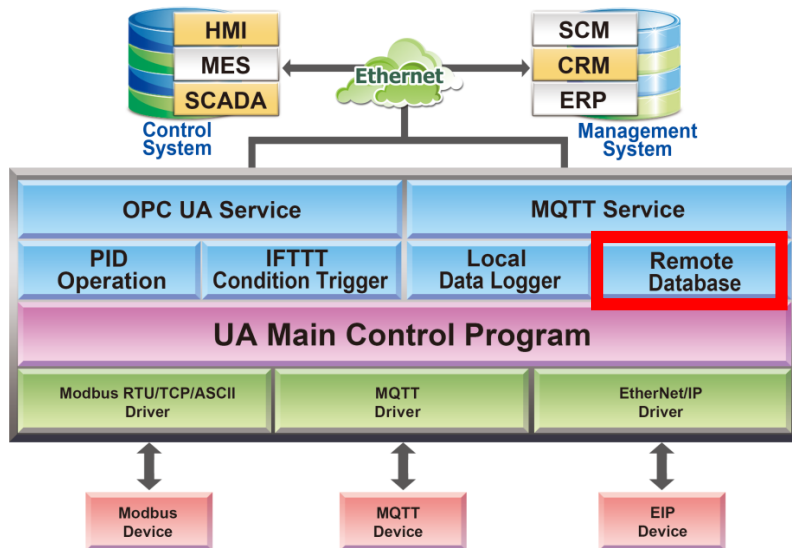

#### Application:

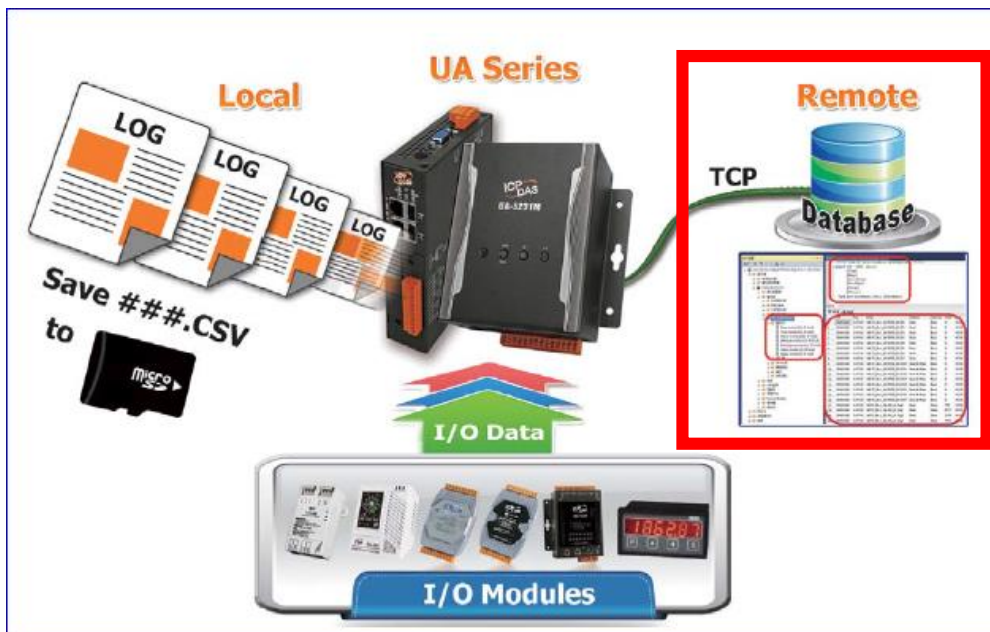

Enter the main menu [Advanced Setting] > [Data Logger] > [MySQL/MariaDB], enter a name (e.g. "ICPDAS\_Cycle\_DateTime"), and click the plus sign to add a MySQL or DariaDB remote database list.

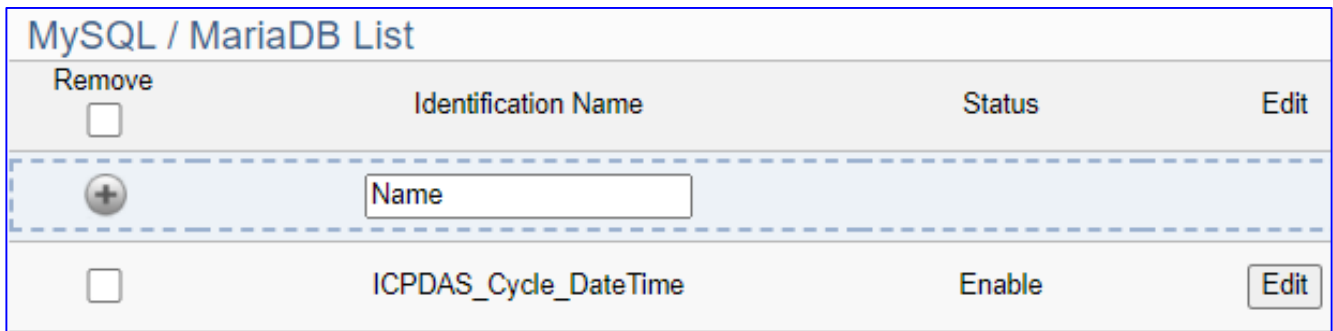
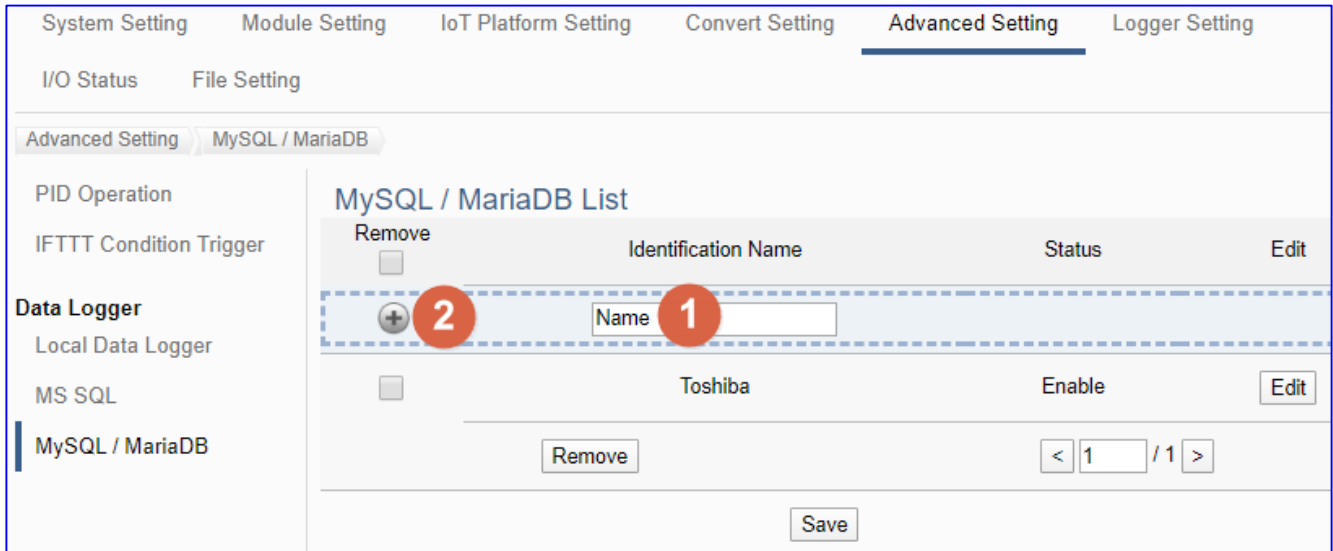

Advanced Setting > Data Logger > MySQL/MariaDB – MySQL/MariaDB List	
<input type="checkbox"/> Remove	Check Remove box to remove all database connection in list. Check the box of each database and click the "Remove" button can remove just that database connection.
Identification Name	User defined name to identify the remote database. Default: Name.
Status	Display the status (Enable/Disable) of the database connection. Default: Enable.
	Click to add a new remote database connection.
Edit	Click to enter the "Content Setting" page of the remote database.
	The page number of the database list: Current page / Total pages. Click < or > to go to the previous or next page.
Save	Click to save the settings of this page.

Click "Edit" to enter the "Remote database connect settings" page.

MySQL / MariaDB Connection Settings	
Identification Name	ICPDAS_Cycle_DateTime
Database Name	ICPDAS
Table Name	Module_All_DateTime
IP	192.168.85.11
Port	3306
Account	chris
Password	....
Log Mode	Cycle
Interval Seconds	5
Date Time Format	[yyyy-MM-dd HH:mm:ss]
Enable	<input checked="" type="checkbox"/>
Test Connection	Connection
<input type="button" value="OK"/> <input type="button" value="Cancel"/>	

Advanced Setting > Data Logger > MySQL/MariaDB – Content Settings	
Identification Name	User defined name to identify the database.
Database Name	The name of the remote database. If it does not exist, it will add a new database with this name.
Table Name	The table name of the remote database. If it does not exist, it will add a new table with this name.
IP	The Server IP and name of the remote database.
Port	The port to connect with database. Default: 3306 (for MySQL/MariaDB)
Account	The login name of the remote database.
Password	The login password of the remote database.
Log Mode	<p><b>Cycle:</b> Record one log data at the interval time set below.</p> <p><b>Cycle-Time Alignment:</b> Cycle mode with Time Alignment. Time Alignment is to align records time at the selected interval. It will record the first log at the beginning time. And will align other log times with multiples of the log interval (seconds, minutes, hours). For example, if the log interval is 5 seconds, the first log time is 13:01:04, and the following log records will be 13:01:05, 13:01:10, etc., the seconds being multiples of 5 seconds.</p> <p><b>Data Change:</b> Only record when the data has changed.</p>
Interval Seconds	Set up the interval time to save the I/O data to the remote database. Unit: Second.
Date Time Format	Select to separate the date and time into two [Columns] or combine the date and time in one [Column].
Enable	Check to enable the data logger to the remote database. Default: check.

Advanced Setting > Data Logger > MySQL/MariaDB – Content Settings	
Test Connection	Click to test the connection to the remote database. Result: Success or Failure.
OK / Cancel	Click “OK” to save the settings of this page. Click “Cancel” to exit the setting page without saving.

● **MySQL/MariaDB Remote Database Example Descriptions:**

Each tag data and status are recorded in each separate row, **the row is added down for each interval**, and the tag data is recorded in time sequence.

For database operation, please refer to **FAQ-Dev-002 (MySQL)** of the **UA series FAQ list**: [FAQ-Dev-002\\_How to save the UA collected data into SQL and then show trend chart in InduSoft? \(Take MySQL Installer 5.7.31 as an example\)](#)

The connection screen view of the **MySQL Remote Database**.

**1. MySQL database screen view: Date/Time column separated (reference)**

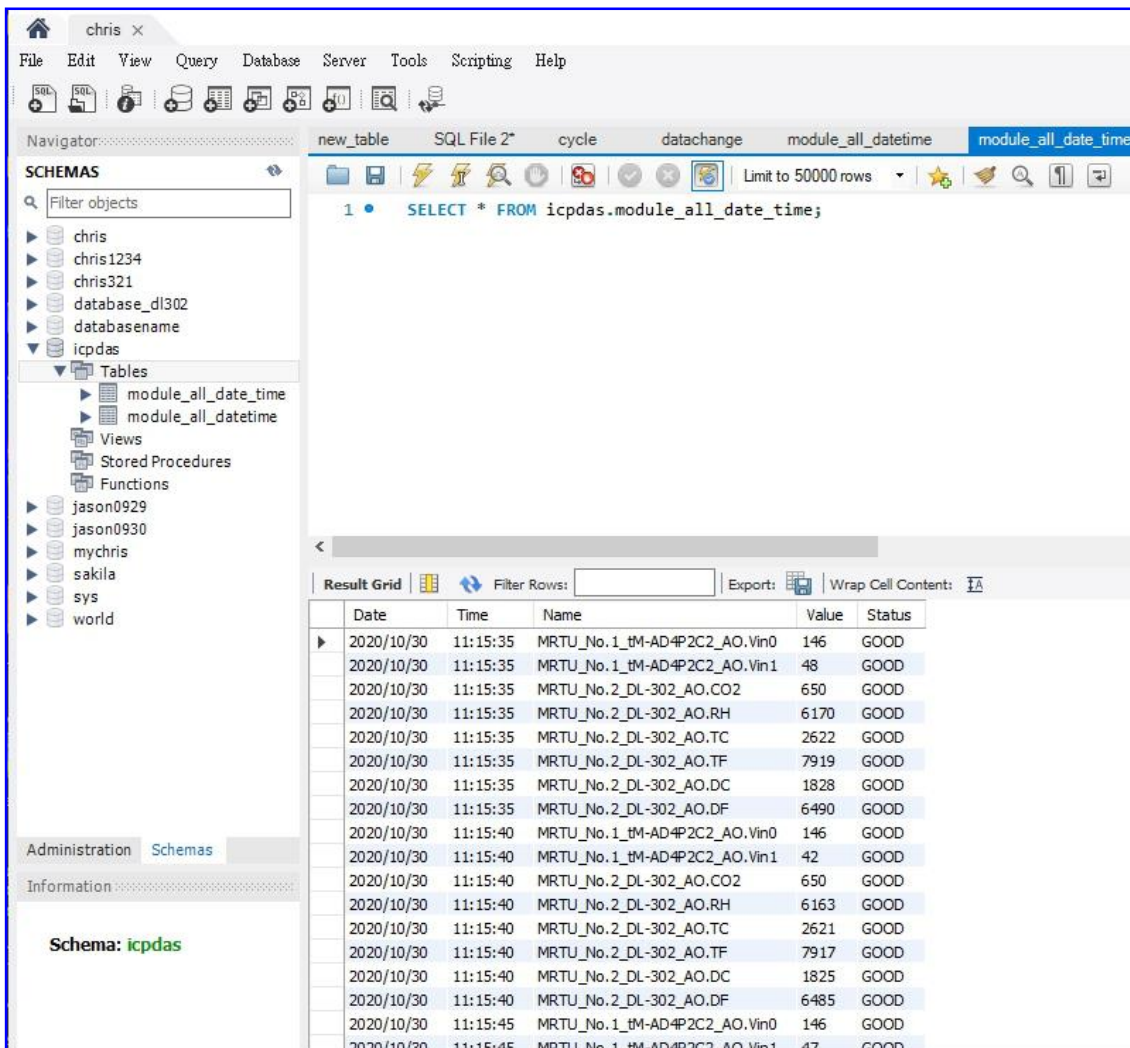

## 2. MySQL database screen view: Date/Time column combined (reference)

The screenshot shows a MySQL database management interface. The left sidebar displays a tree view of schemas, with 'icpdas' expanded to show tables 'module\_all\_date\_time' and 'module\_all\_datetime'. The main window shows a query editor with the SQL statement: `SELECT * FROM icpdas.module_all_datetime;`. Below the editor is a 'Result Grid' displaying the query results. The grid has four columns: 'DateTime', 'Name', 'Value', and 'Status'. The data rows show various sensor readings for different modules, all with a status of 'GOOD'.

DateTime	Name	Value	Status
2020-10-30 11:12:19	MRTU_No.1_tM-AD4P2C2_AO.Vin0	146	GOOD
2020-10-30 11:12:19	MRTU_No.1_tM-AD4P2C2_AO.Vin1	54	GOOD
2020-10-30 11:12:19	MRTU_No.2_DL-302_AO.CO2	636	GOOD
2020-10-30 11:12:19	MRTU_No.2_DL-302_AO.RH	6194	GOOD
2020-10-30 11:12:19	MRTU_No.2_DL-302_AO.TC	2616	GOOD
2020-10-30 11:12:19	MRTU_No.2_DL-302_AO.TF	7908	GOOD
2020-10-30 11:12:19	MRTU_No.2_DL-302_AO.DC	1829	GOOD
2020-10-30 11:12:19	MRTU_No.2_DL-302_AO.DF	6492	GOOD
2020-10-30 11:12:24	MRTU_No.1_tM-AD4P2C2_AO.Vin0	146	GOOD
2020-10-30 11:12:24	MRTU_No.1_tM-AD4P2C2_AO.Vin1	55	GOOD
2020-10-30 11:12:24	MRTU_No.2_DL-302_AO.CO2	636	GOOD
2020-10-30 11:12:24	MRTU_No.2_DL-302_AO.RH	6190	GOOD
2020-10-30 11:12:24	MRTU_No.2_DL-302_AO.TC	2616	GOOD
2020-10-30 11:12:24	MRTU_No.2_DL-302_AO.TF	7908	GOOD
2020-10-30 11:12:24	MRTU_No.2_DL-302_AO.DC	1827	GOOD
2020-10-30 11:12:24	MRTU_No.2_DL-302_AO.DF	6488	GOOD
2020-10-30 11:12:29	MRTU_No.1_tM-AD4P2C2_AO.Vin0	146	GOOD
2020-10-30 11:12:29	MRTU_No.1_tM-AD4P2C2_AO.Vin1	52	GOOD

The connection screen view of the **MariaDB Remote Database**.

**1. MariaDB database screen view: Date/Time column separated (reference)**

The screenshot shows the phpMyAdmin interface for a MariaDB 10 database. The database name is 'ICPDAS' and the table is 'Module\_All\_Date\_Time'. The SQL query displayed is 'SELECT \* FROM `Module\_All\_Date\_Time`'. The table view shows 25 columns and 25 rows of data. The columns are Date, Time, Name, Value, and Status. The data rows show various MRTU entries with their respective values and statuses.

	Date	Time	Name	Value	Status
<input type="checkbox"/>	2020/10/30	12:14:44	MRTU_No.1_tM-AD4P2C2_AO.Vin0	146	GOOD
<input type="checkbox"/>	2020/10/30	12:14:44	MRTU_No.1_tM-AD4P2C2_AO.Vin1	59	GOOD
<input type="checkbox"/>	2020/10/30	12:14:44	MRTU_No.2_DL-302_AO.CO2	637	GOOD
<input type="checkbox"/>	2020/10/30	12:14:44	MRTU_No.2_DL-302_AO.DC	1822	GOOD
<input type="checkbox"/>	2020/10/30	12:14:44	MRTU_No.2_DL-302_AO.DF	6479	GOOD
<input type="checkbox"/>	2020/10/30	12:14:44	MRTU_No.2_DL-302_AO.RH	6099	GOOD
<input type="checkbox"/>	2020/10/30	12:14:44	MRTU_No.2_DL-302_AO.TC	2635	GOOD
<input type="checkbox"/>	2020/10/30	12:14:44	MRTU_No.2_DL-302_AO.TF	7943	GOOD
<input type="checkbox"/>	2020/10/30	12:14:49	MRTU_No.1_tM-AD4P2C2_AO.Vin0	146	GOOD
<input type="checkbox"/>	2020/10/30	12:14:49	MRTU_No.1_tM-AD4P2C2_AO.Vin1	63	GOOD
<input type="checkbox"/>	2020/10/30	12:14:49	MRTU_No.2_DL-302_AO.CO2	636	GOOD
<input type="checkbox"/>	2020/10/30	12:14:49	MRTU_No.2_DL-302_AO.DC	1819	GOOD
<input type="checkbox"/>	2020/10/30	12:14:49	MRTU_No.2_DL-302_AO.DF	6474	GOOD
<input type="checkbox"/>	2020/10/30	12:14:49	MRTU_No.2_DL-302_AO.RH	6093	GOOD
<input type="checkbox"/>	2020/10/30	12:14:49	MRTU_No.2_DL-302_AO.TC	2634	GOOD
<input type="checkbox"/>	2020/10/30	12:14:49	MRTU_No.2_DL-302_AO.TF	7941	GOOD
<input type="checkbox"/>	2020/10/30	12:14:54	MRTU_No.1_tM-AD4P2C2_AO.Vin0	146	GOOD
<input type="checkbox"/>	2020/10/30	12:14:54	MRTU_No.1_tM-AD4P2C2_AO.Vin1	64	GOOD
<input type="checkbox"/>	2020/10/30	12:14:54	MRTU_No.2_DL-302_AO.CO2	636	GOOD
<input type="checkbox"/>	2020/10/30	12:14:54	MRTU_No.2_DL-302_AO.DC	1820	GOOD
<input type="checkbox"/>	2020/10/30	12:14:54	MRTU_No.2_DL-302_AO.DF	6476	GOOD
<input type="checkbox"/>	2020/10/30	12:14:54	MRTU_No.2_DL-302_AO.RH	6092	GOOD
<input type="checkbox"/>	2020/10/30	12:14:54	MRTU_No.2_DL-302_AO.TC	2635	GOOD
<input type="checkbox"/>	2020/10/30	12:14:54	MRTU_No.2_DL-302_AO.TF	7943	GOOD

## 2. MariaDB database screen view: Date/Time column combined (reference)

The screenshot shows the phpMyAdmin interface for a MariaDB 10 database named 'ICPDAS'. The selected table is 'Module\_All\_DateTime'. The SQL query displayed is 'SELECT \* FROM `Module\_All\_DateTime`'. The table view shows 25 columns per page, with the first column being 'DateTime'. The data rows show a list of records with columns: DateTime, Name, Value, and Status. The status for all records is 'GOOD'.

	DateTime	Name	Value	Status
<input type="checkbox"/>	2020-10-30 12:22:17	MRTU_No.1_tM-AD4P2C2_AO.Vin0	146	GOOD
<input type="checkbox"/>	2020-10-30 12:22:17	MRTU_No.1_tM-AD4P2C2_AO.Vin1	61	GOOD
<input type="checkbox"/>	2020-10-30 12:22:17	MRTU_No.2_DL-302_AO.CO2	640	GOOD
<input type="checkbox"/>	2020-10-30 12:22:17	MRTU_No.2_DL-302_AO.DC	1812	GOOD
<input type="checkbox"/>	2020-10-30 12:22:17	MRTU_No.2_DL-302_AO.DF	6461	GOOD
<input type="checkbox"/>	2020-10-30 12:22:17	MRTU_No.2_DL-302_AO.RH	6036	GOOD
<input type="checkbox"/>	2020-10-30 12:22:17	MRTU_No.2_DL-302_AO.TC	2642	GOOD
<input type="checkbox"/>	2020-10-30 12:22:17	MRTU_No.2_DL-302_AO.TF	7955	GOOD
<input type="checkbox"/>	2020-10-30 12:22:22	MRTU_No.1_tM-AD4P2C2_AO.Vin0	146	GOOD
<input type="checkbox"/>	2020-10-30 12:22:22	MRTU_No.1_tM-AD4P2C2_AO.Vin1	62	GOOD
<input type="checkbox"/>	2020-10-30 12:22:22	MRTU_No.2_DL-302_AO.CO2	640	GOOD
<input type="checkbox"/>	2020-10-30 12:22:22	MRTU_No.2_DL-302_AO.DC	1812	GOOD
<input type="checkbox"/>	2020-10-30 12:22:22	MRTU_No.2_DL-302_AO.DF	6461	GOOD
<input type="checkbox"/>	2020-10-30 12:22:22	MRTU_No.2_DL-302_AO.RH	6038	GOOD
<input type="checkbox"/>	2020-10-30 12:22:22	MRTU_No.2_DL-302_AO.TC	2642	GOOD
<input type="checkbox"/>	2020-10-30 12:22:22	MRTU_No.2_DL-302_AO.TF	7955	GOOD
<input type="checkbox"/>	2020-10-30 12:22:27	MRTU_No.1_tM-AD4P2C2_AO.Vin0	146	GOOD
<input type="checkbox"/>	2020-10-30 12:22:27	MRTU_No.1_tM-AD4P2C2_AO.Vin1	59	GOOD
<input type="checkbox"/>	2020-10-30 12:22:27	MRTU_No.2_DL-302_AO.CO2	640	GOOD
<input type="checkbox"/>	2020-10-30 12:22:27	MRTU_No.2_DL-302_AO.DC	1811	GOOD
<input type="checkbox"/>	2020-10-30 12:22:27	MRTU_No.2_DL-302_AO.DF	6459	GOOD
<input type="checkbox"/>	2020-10-30 12:22:27	MRTU_No.2_DL-302_AO.RH	6038	GOOD
<input type="checkbox"/>	2020-10-30 12:22:27	MRTU_No.2_DL-302_AO.TC	2641	GOOD
<input type="checkbox"/>	2020-10-30 12:22:27	MRTU_No.2_DL-302_AO.TF	7953	GOOD

### 5.5.8 Block List: Block Rule

UA supports a dynamic block list function for information security. This function can set up the rules to block IP connections. When the conditions have met the rules, the system can add the IP to the block list and block it through the firewall. It also provides the IP situation of the block list and the function to unblock the current blocked IP.

The Block List function includes: Block Rule (this section) and Block Status (next section).

Enter the menu [Advanced Setting] > [Block List] - [Block Rule], the screen is as follows.

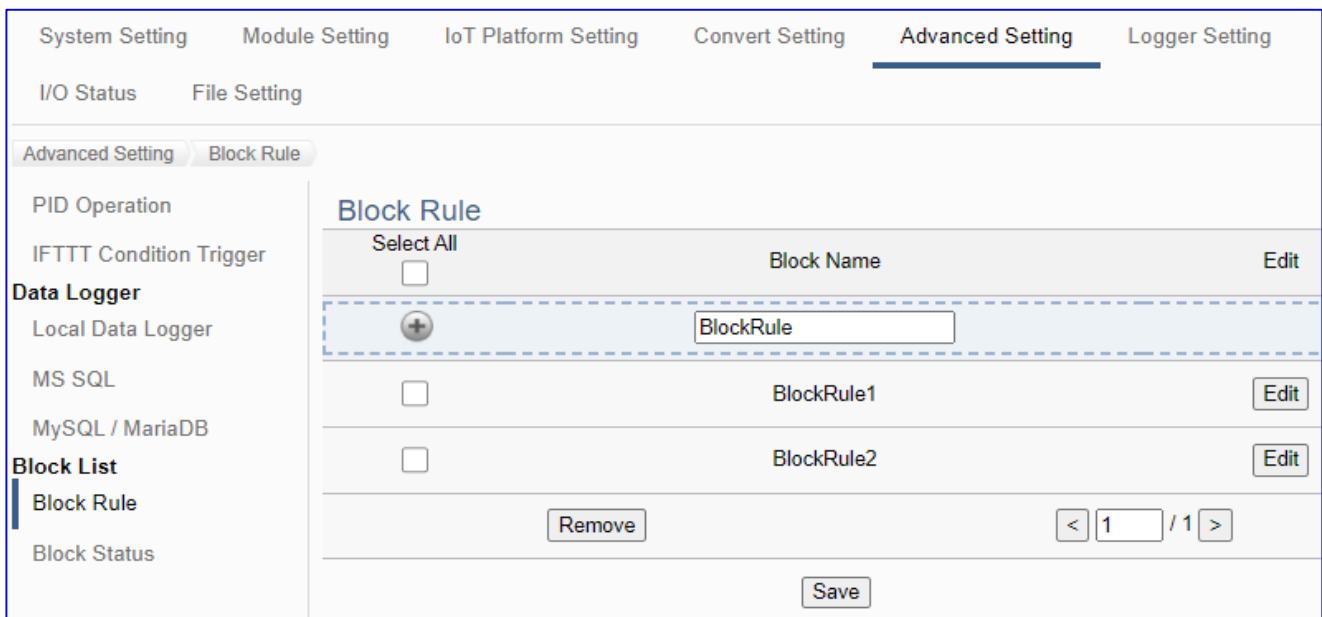

Advanced Setting > Block List > Block Rule – Block Rule	
Select All 	Check “Select All” box can select all block rules in the list. Check the box of each list can select one list, and click the “Remove” button can remove just that rule.
Block Name	User defined name to identify the block rules. Default: BlockRule.
	Click  can add a new Block Name, and then click the [Edit] to set up the Block Rule
Edit	Click the [Edit] button to edit the block rules.
Remove	Check the box of the list and click the “Remove” button can remove that rule.
	The page number of the list: Current page / Total pages. Click < or > to go to the previous or next page.
Save	Click to save the settings of this page.

Click the [Edit] button of the Block List to edit the block rules.

Block Rule	
Block Name	<input type="text" value="BlockRule1"/>
Monitor Port	<input type="text" value="48010"/>
Condition	
Established Connections	<input type="text" value="10"/>
SYN_RECV Connections	<input type="text" value="5"/>
CLOSE_WAIT Connections	<input type="text" value="5"/>
Interval Time(s)	<input type="text" value="30"/>
<input type="button" value="OK"/> <input type="button" value="Cancel"/>	

Advanced Setting > Block List > Block Rule – Block Rule (Edit)	
Block Name	Set the Block Rule Name
Monitor Port	Set the number of the monitor port
Condition	Set and check the connection status threshold and the interval for the IP block list of the monitoring port.
Established Connections	The threshold for established connections
SYN_RECV Connections	The threshold for SYN_RECV connections
CLOSE_WAIT Connections	The threshold for CLOSE_WAIT connections
Interval Time(s)	Set the interval time to check (in seconds)
OK / Cancel	Click [OK] to save the settings of this page, and exit. Click [Cancel] to exit this page but do not save the settings.

### 5.5.9 Block List: Block Status

UA supports a dynamic block list function for information security. This function can set up the rules to block IP connections. When the conditions have met the rules, the system can add the IP to the block list and block it through the firewall. It also provides the IP situation of the block list and the function to unblock the current blocked IP.

The Block List function includes: Block Rule (previous section) and Block Status (this section).

Enter the menu [Advanced Setting] > [Block List] - [Block Status], the screen is as follows.

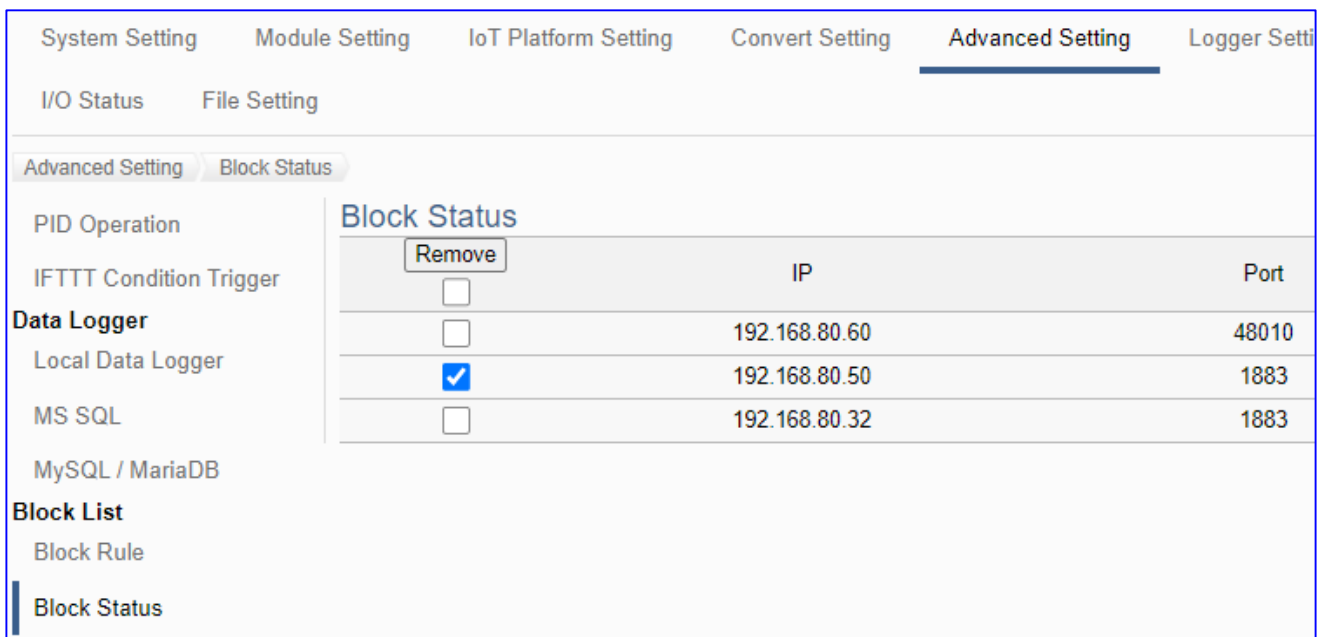

Advanced Setting > Block List > Block Status – Block Status	
IP	Display the blocked IP and port number of the block list.
Port	Can remove the blocked IP from the block list via the "Remove" button.
Remove	Check the box of the list and click the “Remove” button can remove the IP from the Block List.

## 5.6 Main Menu: Logger Setting

**Logger Setting** is the 6<sup>th</sup> item of the Main Menu, mainly to provide the data logger and the connecting modules related settings.

“Logger Setting” provides “Local Data Logger”, “MS SQL” and “MySQL/MariaDB”, and all have RTU/TCP module two setting items. The Local Data Logger provides users to record data such as RTU/TCP module (Master) channel data into Local CSV log files of the microSD card in UA. The “MS SQL” or “MySQL / MariaDB” Remote Database provides users to record data between RTU/TCP module (Master) channel data directly into remote database, such as SQL DB.

Logger Setting	
<b>Local Data Logger</b>	
RTU Module (Master)	Provide users to record data such as RTU module (Master) channel and internal register.
TCP Module (Master)	Provide users to record data such as TCP module (Master) channel and internal register.
<b>MS SQL</b>	
RTU Module (Master)	Provide users to record data between RTU module (Master) channel and MS SQL.
TCP Module (Master)	Provide users to record data between TCP module (Master) channel and MS SQL.
MQTT Module	Provide users to record data between MQTT module channel and MS SQL.
<b>MySQL / MariaDB</b>	
RTU Module (Master)	Provide users to record data between RTU module (Master) channel and MySQL / MariaDB.
TCP Module (Master)	Provide users to record data between TCP module (Master) channel and MySQL / MariaDB.
MQTT Module	Provide users to record data between MQTT channel and MySQL / MariaDB.

The setting for UA series controllers is to set up from the left to the right of the main menu functions. User can find the setting step and Web UI information in the following chapters.

[CH2 Quick Start 1: Hardware/Network Connection](#)

[CH3 Quick Start 2: Web UI / Setting Steps](#)

[CH4 Function Wizard: Project Quick Setup](#)

### 5.6.1 Local Data Logger: RTU / TCP Module (Master)

“Local Data Logger” of “Logger Setting” provides users to record I/O log data of the connecting RTU/TCP module (Master) into the local microSD card.

This function is for setting the local data logger and the RTU/TCP modules, using “RTU” module setting as an example. For the setting about the logger and microSD card, please refer to [Chapter 5.5.3](#).

**Function Diagram:**

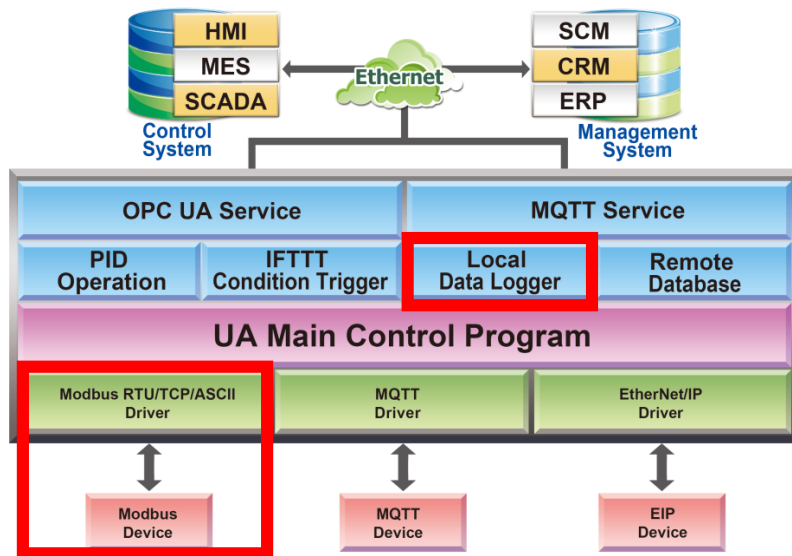

**Application:**

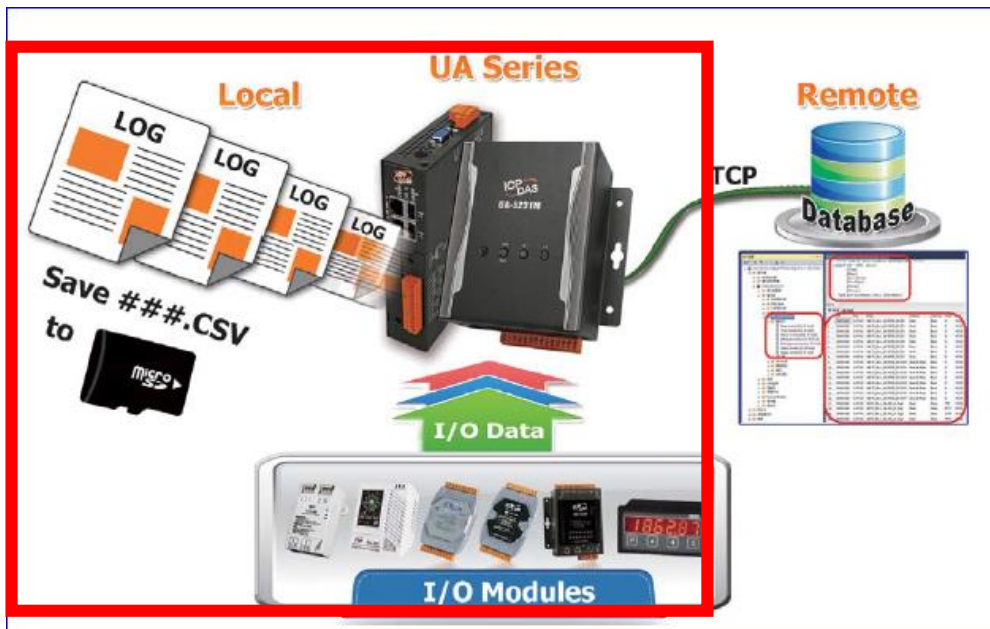

Enter the main menu [Logger Setting] > [Local Data Logger] > [RTU Module (Master)].  
 This setting page is to enable the module(s) or I/O channels for data logger.

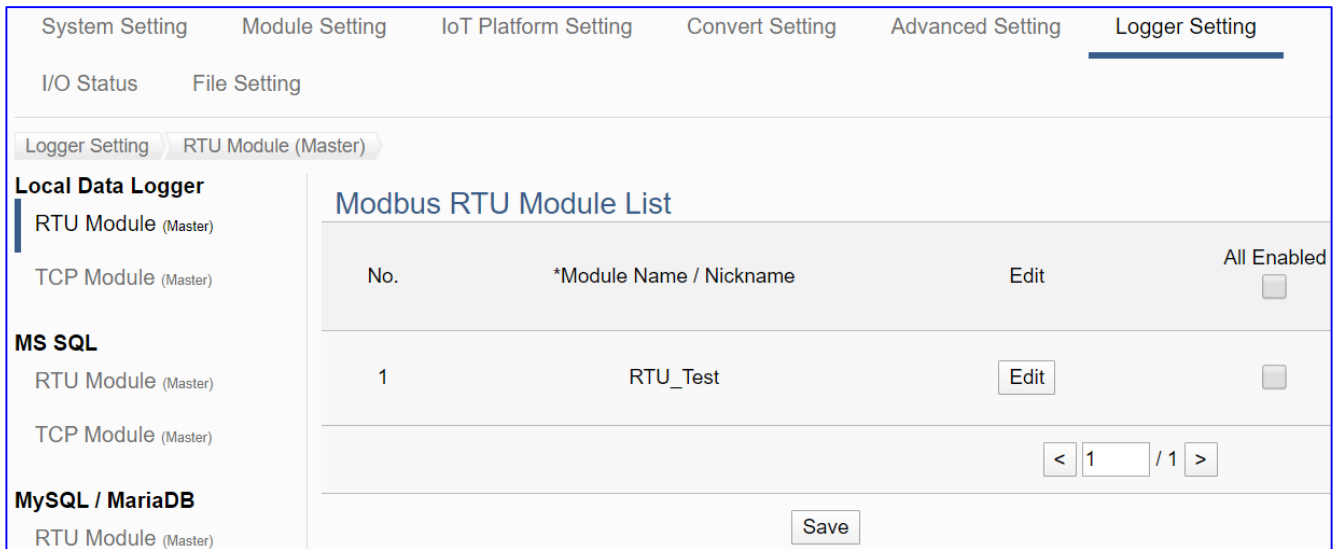

Logger Setting > Local Data Logger - RTU Module (Master) – Modbus Module List	
No.	The module number in the module list (Not editable here)
*Module Name / Nickname	The module name set in the module list (Not editable here)
Edit	If user wants to enable some I/O channels for data logger, click [Edit] of that module to enter the “Variable Tale” setting. It is normal to set all channels as enabled, and the conversion will not affect the unconnected channels.
All Enabled <input type="checkbox"/> <input type="checkbox"/> Enable	Check [All Enabled] box to enable all modules in list for data logger. Default: Uncheck. Check the box of each module can enable just that module for data logger.
<input type="button" value="&lt;"/> <input type="text" value="1"/> / 1 <input type="button" value="&gt;"/>	The page number of the module list: Current page / Total pages. Click < or > to go to the previous or next page.
Save	Click to save the settings of this page.

This function is to enable the module for data logger, please check  the box of the module. If user wants to enable some I/O of the module, please click [Edit] button to enter the “Module Content Setting” page.

The “Module Content Setting” page after clicking the [Edit] button:

### Module Content Setting

No.	<input style="width: 90%;" type="text" value="1"/>
Module Name	<input style="width: 90%;" type="text" value="RTU_Test"/>

### Variable Table

Variable Name	Attribute	Data Type	Enabled
<input style="width: 90%;" type="text" value="Tag14"/>	<input style="width: 90%;" type="text" value="Read / Write"/>	Unsigned Short	<input checked="" type="checkbox"/>
<input style="width: 90%;" type="text" value="Tag15"/>	<input style="width: 90%;" type="text" value="Read / Write"/>	Unsigned Short	<input checked="" type="checkbox"/>

<b>Logger Setting &gt; Local Data Logger &gt; RTU Module (Master) – Content Setting</b>	
No.	The module number in the module list (Not editable here)
Module Name	The module name set in the module list (Not editable here)
<b>Logger Setting &gt; OPC UA &gt; Modbus RTU (Master) – Variable Table</b>	
Variable Name	Display the variable name that set in the Modbus Address Mapping Table page (Not editable here)
Attribute	Display data attribute of the variable. (Not editable) Include: Read, Read/Write...
Data Type	Display data type of the variable that set in the Modbus Address Mapping Table page. (Not editable) Include: Bool, Short, Float...
Enabled	Check [Enabled] box of the top row can enable all variables in list. Check the box of each variable can enable just that variable for data logger. Default: Uncheck.
OK	Click to save this page settings and back to the module list page.

When complete the setting, click [OK] to save this page settings and back to the module list page. Remember to click [Save] to save the Convert Setting.

### 5.6.2 MS SQL: RTU / TCP / MQTT Module (Master)

“MS SQL” of “Logger Setting” provides users to record I/O log data of the connecting RTU/TCP/MQTT module (Master) into the MS SQL remote database.

This function is for setting the remote data logger and the RTU/TCP modules, using “**TCP module**” setting as an example. For the setting about the MS SQL data logger, please refer to [Chapter 5.5.4](#).

#### Function Diagram:

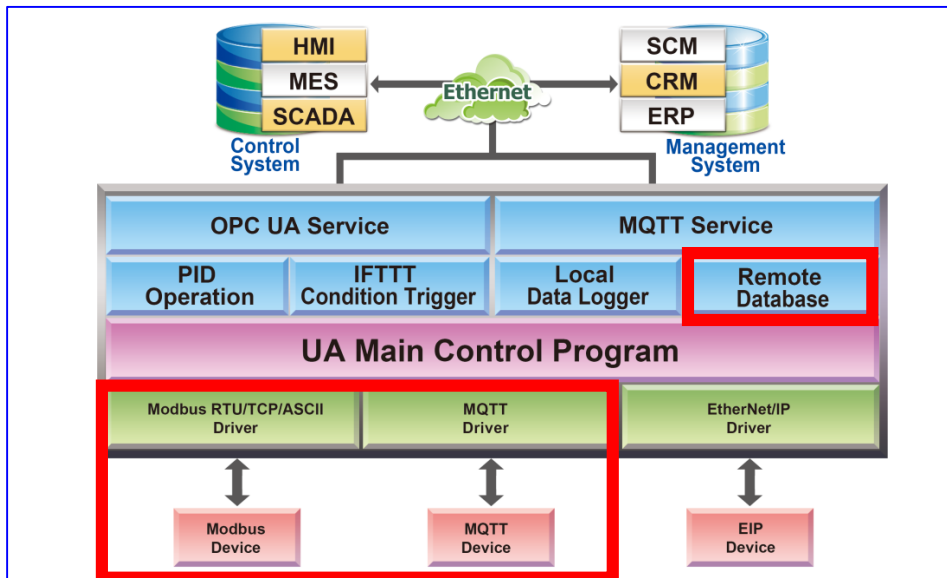

#### Application:

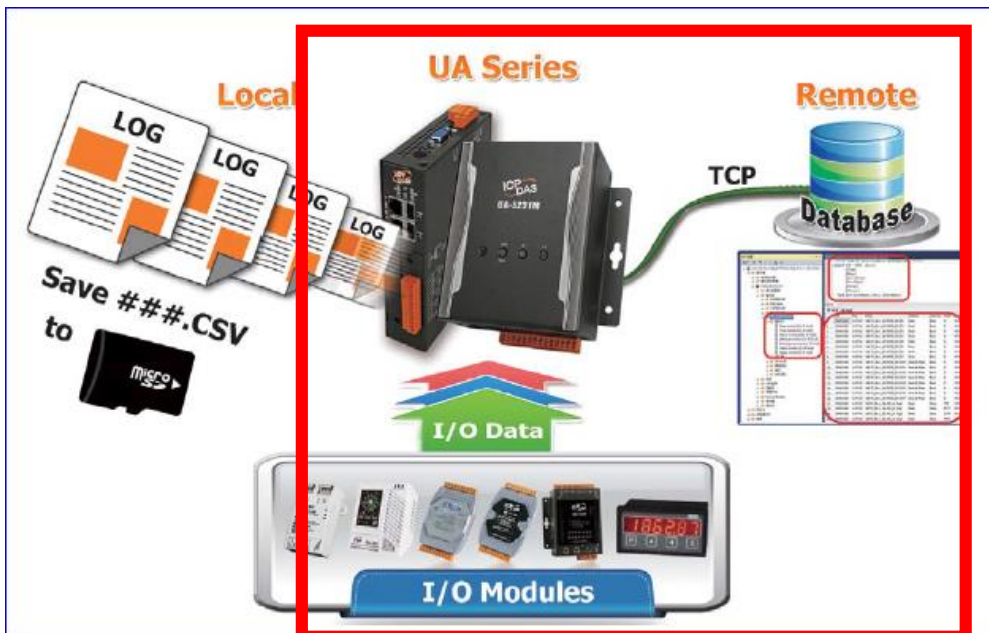

Enter the main menu [Logger Setting] > [MS SQL] > [TCP Module (Master)], e.g. the remote database Name as below.

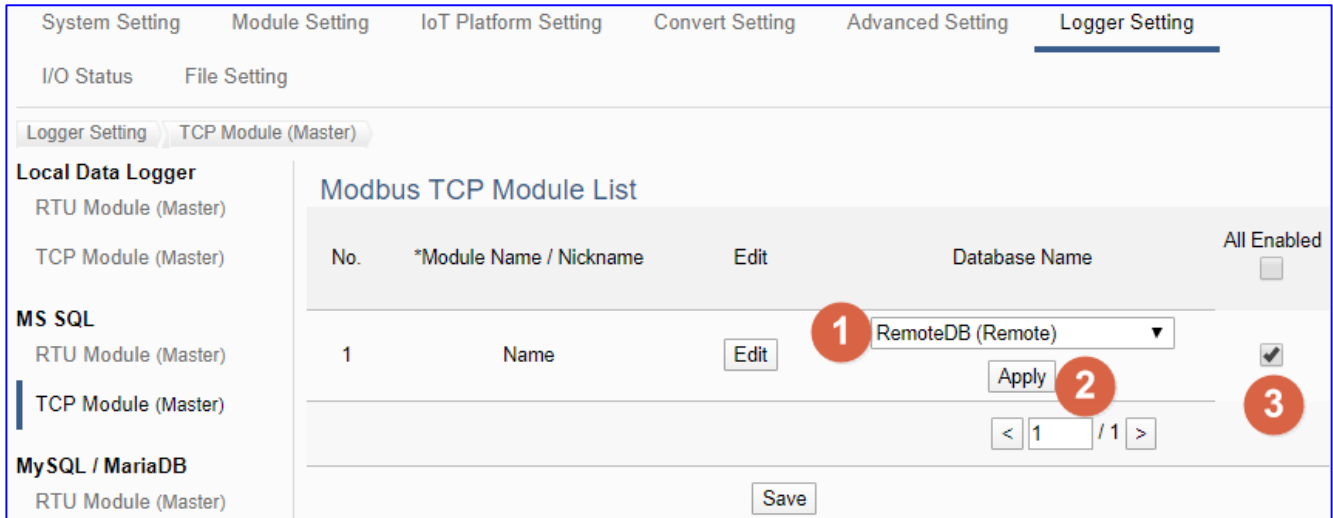

Logger Setting > MS SQL - TCP Module (Master) > Modbus TCP Module List	
No.	The module number in the module list (Not editable here)
*Module Name / Nickname	The module name set in the module list (Not editable here)
Edit	If user wants to enable some I/O channels for data logger, click [Edit] of that module to enter the “Variable Tale” setting. It is normal to set all channels as enabled, and the conversion will not affect the unconnected channels.
Database Name Apply	Select the database name set in the “MS SQL” of the “Advanced Setting”. Click “Apply” (Text color will change from black to gray).
All Enabled <input type="checkbox"/> <input type="checkbox"/> Enabled	Check [All Enabled] box to enable all modules in list for data logger. Default: Uncheck. Check the box of each module can enable just that module for data logger.
<input type="button" value="&lt;"/> 1 <input type="button" value="/"/> 1 <input type="button" value="&gt;"/>	The page number of the module list: Current page / Total pages. Click < or > to go to the previous or next page.
Save	Click to save the settings of this page.

First select [**Database name**] and click [**Apply**] button, and check the **enable box** of the module. If user wants to enable some I/O of the module, please click [Edit] button to enter the “Module Content Setting” page.

### Module Content Setting

No.	<input type="text" value="1"/>
Module Name	<input type="text" value="Name"/>

### Variable Table

Details

Variable Name	Attribute	Data Type	Database Name	Enabled
<input type="text" value="Tag30"/>	<input type="text" value="Read"/>	Short	<input type="text" value="RemoteDB (Remote)"/>	<input checked="" type="checkbox"/>
<input type="text" value="eagle"/>	<input type="text" value="Read / Write"/>	Short	<input type="text" value="RemoteDB (Remote)"/>	<input checked="" type="checkbox"/>

<b>Logger Setting &gt; MS SQL &gt; TCP Module (Master) – Module Content Setting</b>	
No.	The module number in the module list (Not editable here)
Module Name	The module name set in the module list (Not editable here)
<b>Logger Setting &gt; MS SQL &gt; TCP Module (Master) – Variable Table</b>	
Variable Name	Display the variable name that set in the Modbus Address Mapping Table page (Not editable here)
Attribute	Display data attribute of the variable. (Not editable) Include: Read, Read/Write...
Data Type	Display data type of the variable that set in the Modbus Address Mapping Table page. (Not editable) Include: Bool, Short, Float...
Database Name	Display the database name select in previous setting page. (Not editable here)
Enabled <input type="checkbox"/>	Check [Enabled] box of the top row can enable all variables in list. Check the box of each variable can enable just that variable for conversion. Default: Uncheck.
OK / Cancel	Click "OK" to save this page settings and back to the module list page. Click "Cancel" to leave this page without save.

### 5.6.3 MySQL / MariaDB: RTU / TCP / MQTT Module (Master)

“MySQL / MariaDB” of “Logger Setting” provides users to record I/O log data of the connecting RTU/TCP/MQTT module (Master) into the MySQL / MariaDB remote database.

This function is for setting the remote data logger and the RTU/TCP modules, using “**RTU module**” setting as an example. For the setting about the MySQL / MariaDB data logger, please refer to [Chapter 5.5.5](#).

#### Function Diagram:

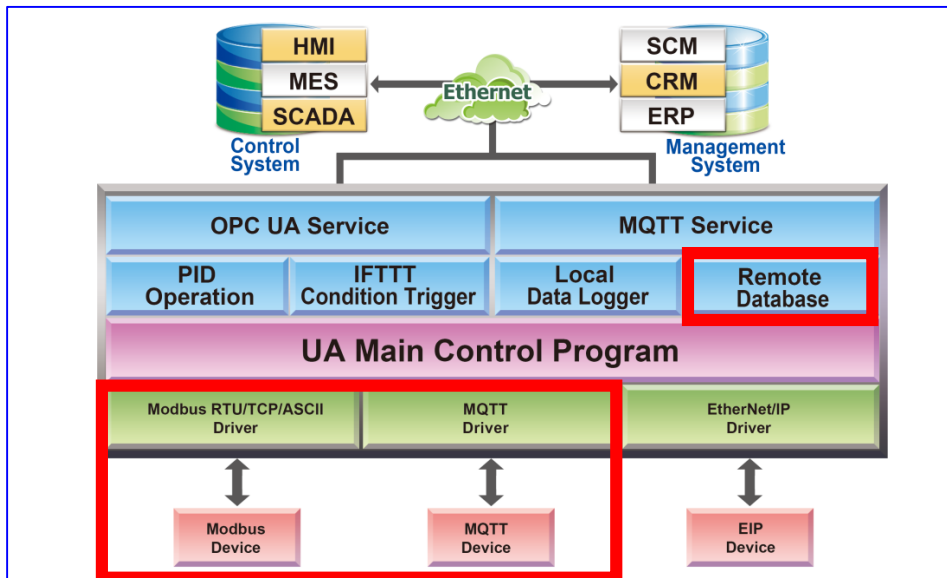

#### Application:

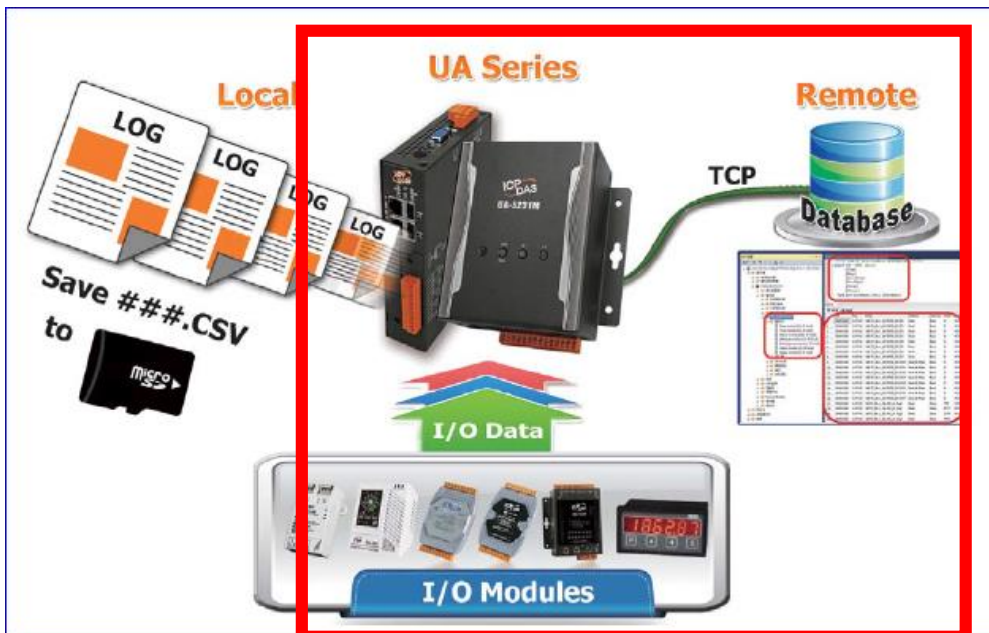

Enter the main menu [Logger Setting] > [MySQL / MariaDB] > [RTU Module (Master)], e.g. the remote database Name “Toshiba”, as below.

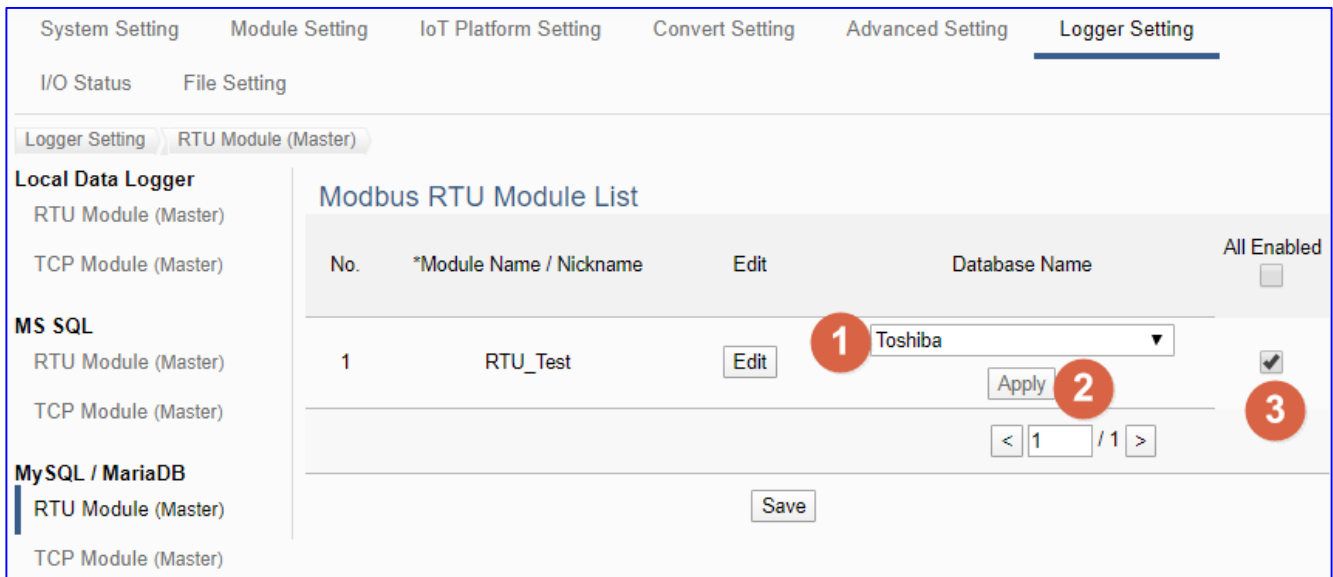

Logger Setting > MySQL/MariaDB - RTU Module (Master) - Module List	
No.	The module number in the module list (Not editable here)
*Module Name / Nickname	The module name set in the module list (Not editable here)
Edit	If user wants to enable some I/O channels for data logger, click [Edit] of that module to enter the “Variable Tale” setting. It is normal to set all channels as enabled, and the conversion will not affect the unconnected channels.
Database Name Apply	Select the database name set in the “MS SQL” of the “Advanced Setting”. Click “Apply” (Text color will change from black to gray).
All Enabled <input type="checkbox"/>  <input type="checkbox"/> Enabled	Check [All Enabled] box to enable all modules in list for data logger. Default: Uncheck. Check the box of each module can enable just that module for data logger.
<input type="button" value=" &lt; 1 / 1 &gt;"/>	The page number of the module list: Current page / Total pages. Click < or > to go to the previous or next page.
Save	Click to save the settings of this page.

First select [**Database name**] and click [**Apply**] button, and check the **enable box** of the module. If user wants to enable some I/O of the module, please click [Edit] button to enter the “Module Content Setting” page.

### Module Content Setting

No.	<input style="width: 80%;" type="text" value="1"/>
Module Name	<input style="width: 80%;" type="text" value="RTU_Test"/>

### Variable Table

Details

Variable Name	Attribute	Data Type	Database Name	Enabled
<input style="width: 80%;" type="text" value="Tag14"/>	Read / Write ▾	Unsigned Short	<input style="width: 80%;" type="text" value="Toshiba"/> ▾	<input checked="" type="checkbox"/>
<input style="width: 80%;" type="text" value="Tag15"/>	Read / Write ▾	Unsigned Short	<input style="width: 80%;" type="text" value="Toshiba"/> ▾	<input checked="" type="checkbox"/>

<b>Logger Setting &gt; MySQL/MariaDB - RTU Module (Master) – Module Content Setting</b>	
No.	The module number in the module list (Not editable here)
Module Name	The module name set in the module list (Not editable here)
<b>Logger Setting &gt; MySQL/MariaDB - RTU Module (Master) – Variable Table</b>	
Variable Name	Display the variable name that set in the Modbus Address Mapping Table page (Not editable here)
Attribute	Display data attribute of the variable. (Not editable) Include: Read, Read/Write...
Data Type	Display data type of the variable that set in the Modbus Address Mapping Table page. (Not editable) Include: Bool, Short, Float...
Database Name	Display the database name select in previous setting page. (Not editable here)
Enabled <input type="checkbox"/>	Check [Enabled] box of the top row can enable all variables in list. Check the box of each variable can enable just that variable for conversion. Default: Uncheck.
OK / Cancel	Click "OK" to save this page settings and back to the module list page. Click "Cancel" to leave this page without save.

## 5.7 Main Menu: I/O Status

**I/O Status** is the 6<sup>th</sup> item of the Main Menu, mainly to display the realtime I/O status of all the modules.

I/O Status page offers an easy way to view monitoring page that allows you to view important controller information in real time. The I/O Status page includes the following information.

- i. System default I/O Status page: It displays the all I/O channel information based on the sorting of all I/O Modules.
- ii. Related settings and the user-defined I/O Status page: It displays the I/O channel status based on the user-defined arrangement.

The user can click the module name on the left site, and the right will show all the real time I/O status of the selected module.

And the I/O status for the following:

209

## 5.8 Main Menu: File Setting

**File Setting** is the last item of the Main Menu, mainly to provide the settings about the files, such as remove, update, upload and download the files of the project and certificate.

File Setting provides 4 sub-menu functions. This chapter will introduce the function items and setting parameters.

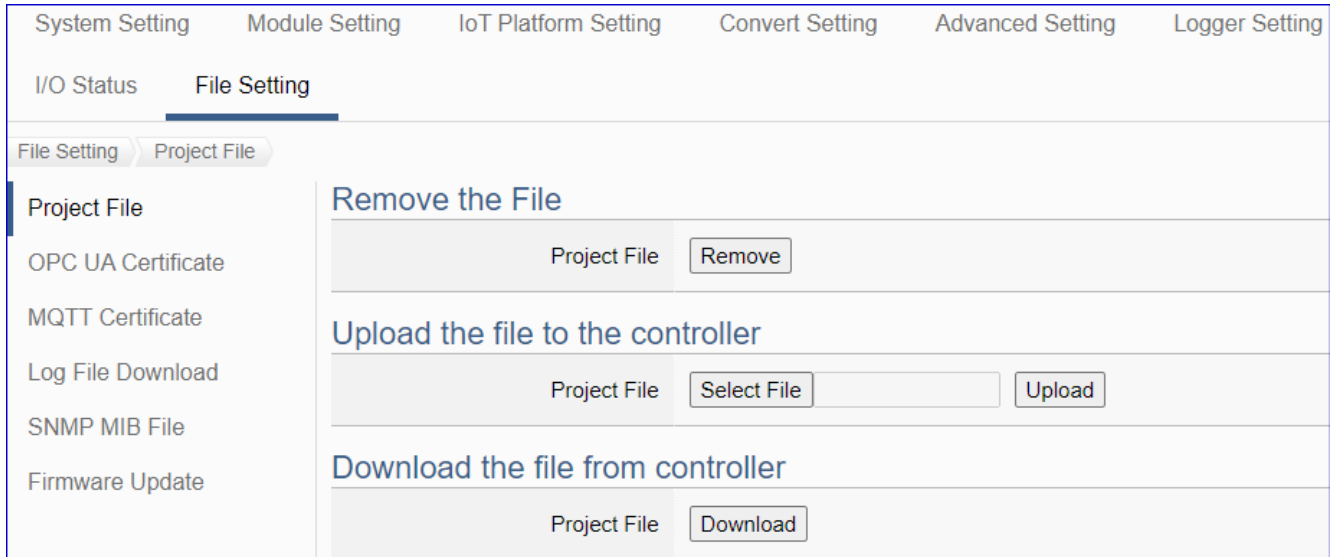

The setting for UA series controllers is to set up from the left to the right of the main menu functions. User can find the setting step and Web UI information in the following chapters.

[CH2 Quick Start 1: Hardware/Network Connection](#)

[CH3 Quick Start 2: Web UI / Setting Steps](#)

[CH4 Function Wizard: Project Quick Setup](#)

### 5.8.1 Project File

This page provides 3 setting items: Remove the file, Upload the file to the controller, and Download the file to the local computer.

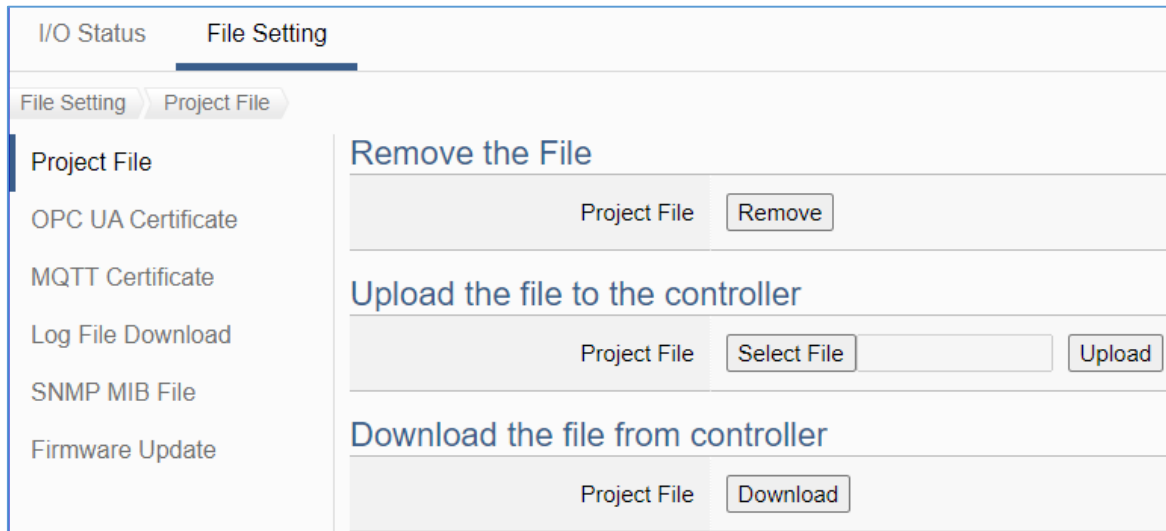

<b>File Setting &gt; Project File &gt; Remove the File</b>	
Project File	Click [Remove] to delete all project settings current in the UA series controller.
<b>File Setting &gt; Project File &gt; Upload the file to the controller</b>	
Project File	<p><b>Select File:</b> click to select the project that want to upload to the UA controller. (Extension name of the project file: “.tar”)</p> <p><b>Upload:</b> upload the project file into the UA controller.</p> <p>If select a wrong file (extension name is not “.tar”), the system will show an error message.</p> <div style="border: 1px solid #ccc; padding: 5px; margin: 5px 0;"> <span>Project File</span> <span>Select File</span> <span>20191211.csv</span> <span style="color: red;">File name is incorrect, default name: Project.tar.</span> <span>Upload</span> </div> <p>Select a right format file with extension name of “.tar”, as below.</p> <div style="border: 1px solid #ccc; padding: 5px; margin: 5px 0;"> <span>Project File</span> <span>Select File</span> <span>Project_192.168.255.</span> <span>Upload</span> </div>
<b>File Setting &gt; Project File &gt; Download the file to the local computer</b>	
Project File	<b>Download:</b> Download the project with all Web UI settings to the current computer. (Extension name of the project file: “.tar”)

### 5.8.2 OPC UA Certificate

UA controller supports OPC UA Server security connection, including identity authentication, data encryption, data signature. Server and Client authenticate each other through x.509 certificate. Compared with the traditional method, it has the following functional advantages.

#### Support Identity Authentication

Identity Authentication			
ICP DAS UA Solution	OPC UA	ID/Password, Anonymous, Certificate	Yes
	MQTT	ID/Password, Anonymous, Certificate	✓
Traditional	Modbus	None	

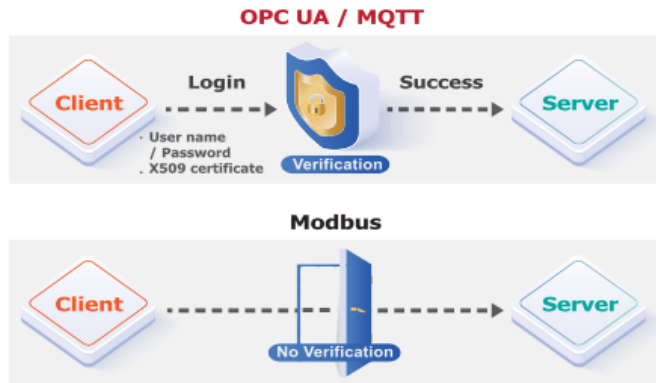

#### Support Data Encryption

Data Encryption			
ICP DAS UA Solution	OPC UA	SSL/TLS Encryption	Yes
	MQTT	SSL/TLS Encryption	✓
Traditional	Modbus	None	

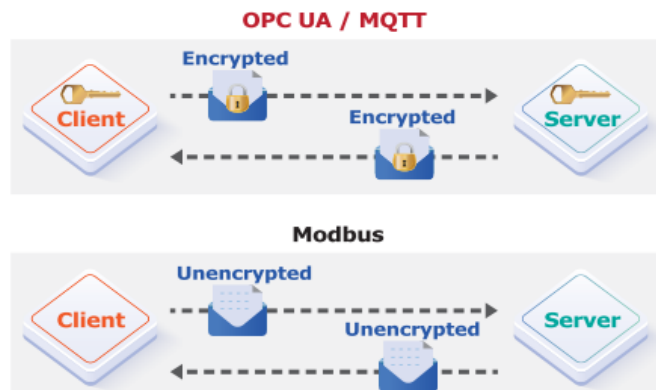

This function is the **certificate** file management function of **OPC UA Server**. There are 3 setting items about OPC UA Certificate: Remove, Upload the file to the controller, download the file from the controller. If your project need not the certificate, you can skip this step.

In the [OPC UA Certificate] step, users can add mutual credentials on both side's devices to strengthen security encryption.

- ① First, obtain the **OPC UA Client** trust certificate file of the device from the connected party, save it to the PC. In this step, select this file and upload it to the UA controller. (If there was an old certificate file in UA, remove it first.)
- ② The device of the other side needs the UA certificate also. In this step, download the **OPC UA Server** certificate file (**Certificate\_IPAddress\_.tar**) to the other party, so that they can decompress the file (**icpdasuaserver.der**) and upload to their device.

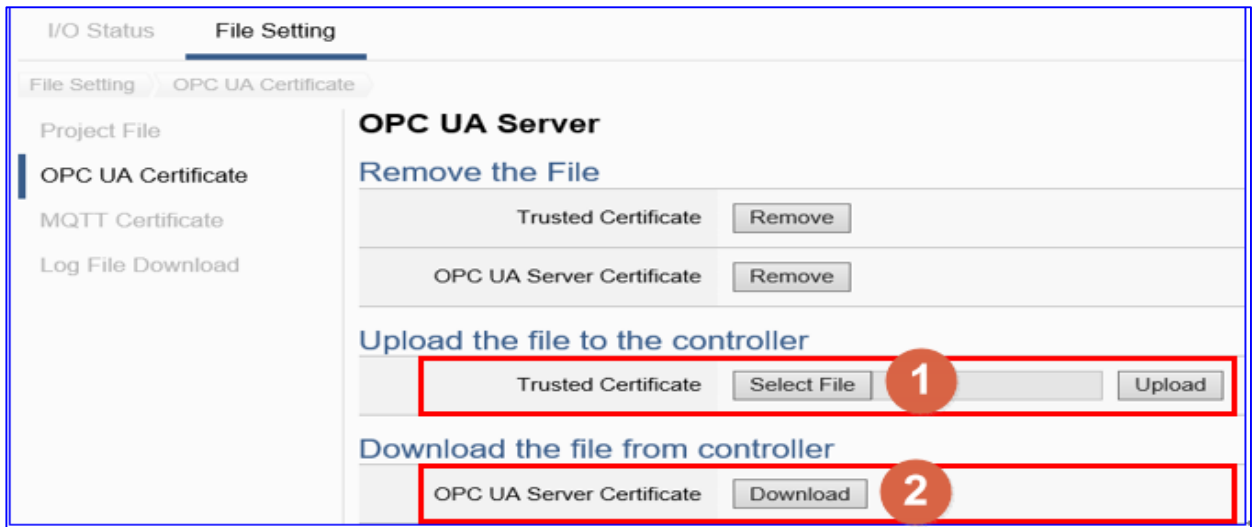

File Setting > OPC UA Certificate > Remove the File	
Trusted Certificate	<b>Remove:</b> Click to delete the OPC UA client Trusted Certificate current in the UA controller.
OPC UA Server Certificate	<b>Remove:</b> Click to delete the OPC UA Server Certificate current in the UA controller.
File Setting > OPC UA Certificate > Upload the file to the controller	
Trusted Certificate	<p><b>Select File:</b> select the OPC UA Trusted Certificate file in PC to upload to the UA controller.</p> <p><b>Upload:</b> upload the Trusted Certificate file to the UA controller.</p> <ul style="list-style-type: none"> <li>File format must be <b>DER</b>. Extension name must be <b>der / cer / crt</b>.</li> </ul> <div style="border: 1px solid #ccc; padding: 5px; margin-bottom: 5px;"> <span>Trusted Certificate</span> <span>Select File</span> <input type="text" value="icpdasuaserver.der"/> <span>Upload</span> </div> <ul style="list-style-type: none"> <li>If select a wrong file, the system will show an error message.</li> </ul> <div style="border: 1px solid #ccc; padding: 5px;"> <span>Trusted Certificate</span> <span>Select File</span> <input type="text" value="Certificate_192.168.255.102"/> <span style="color: red;">Certificate type is wrong.</span> <span>Upload</span> </div>
File Setting > OPC UA Certificate > Download the file from controller	
OPC UA Server Certificate	<p><b>Download:</b> Download the OPC UA Server Certificate file to the current using computer.</p> <ul style="list-style-type: none"> <li>File format: <b>DER</b>. File name: <b>Certificate_IP-address_.tar</b></li> </ul> <p>e.g.  Certificate_192.168.255.102.tar</p> <p>Before using, decompress to <b>icpdasuaserver.der</b>, as below.</p> <div style="border: 1px solid #ccc; padding: 5px; margin-top: 5px;">  icpdasuaserver.der                 </div>

### 5.8.3 MQTT Certificate

UA controller supports MQTT Client secure encrypted certificate file management. There are three types of files: Trusted Certificate, Certificate, and Private Key. Compared with the traditional method, it has the following functional advantages.

#### Support Identity Authentication

Identity Authentication			
ICP DAS UA Solution	OPC UA	ID/Password, Anonymous, Certificate	Yes ✓
	MQTT	ID/Password, Anonymous, Certificate	
Traditional	Modbus	None	

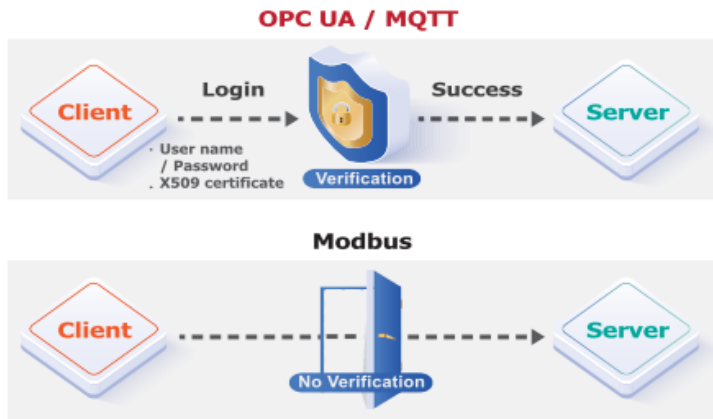

#### Support Data Encryption

Data Encryption			
ICP DAS UA Solution	OPC UA	SSL/TLS Encryption	Yes ✓
	MQTT	SSL/TLS Encryption	
Traditional	Modbus	None	

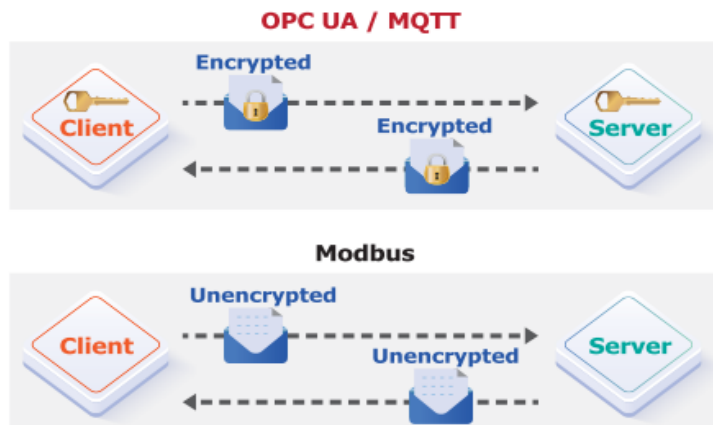

The [MQTT Certificate] is for setting up security communications to upload and remove the MQTT Certificate.

The users upload the file to the UA controller according to the type of obtained certificate. There are 3 types of MQTT Certificate:

- Trusted Certificate
- Certificate
- Private Key

If you want to perform **Broker authentication**, you need to upload the **Trusted Certificate**. If you want to perform the **Broker/Client two-way authentication**, you need to upload the **Credential and Private Key additionally**. The user can skip this step if the user project does not use certificate transmission security.

This page provides 2 setting items: Remove the file, and Upload the file to the controller for the MQTT Trusted Certificate, Certificate and Private Key.

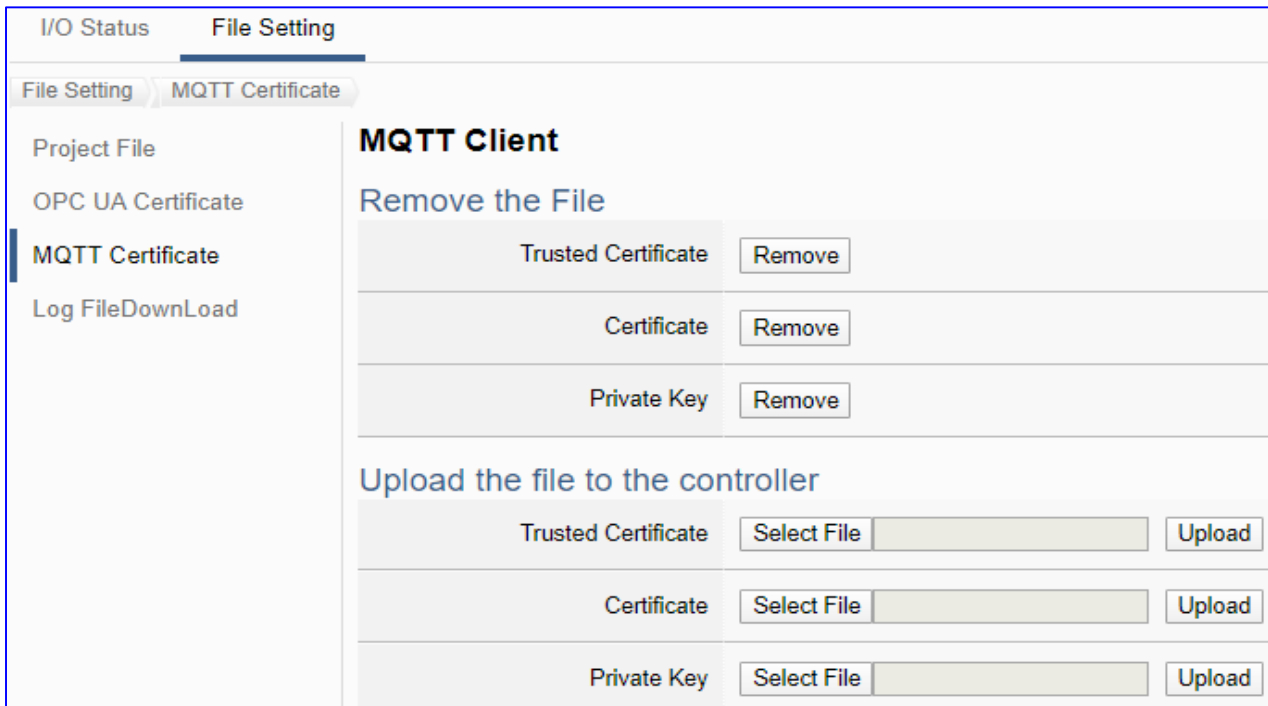

File Setting > MQTT Certificate > Remove the File	
Trusted Certificate	<b>Remove:</b> delete the MQTT Trusted Certificate current in the UA series controller.
Certificate	<b>Remove:</b> delete the MQTT Certificate current in the UA series controller.
Private Key	<b>Remove:</b> delete the MQTT Private Key current in the UA series controller.
File Setting > MQTT Certificate > Upload the file to the controller	
Trusted Certificate	<p><b>Select File:</b> select the MQTT Trusted Certificate file of the device.</p> <p><b>Upload:</b> upload the MQTT Trusted Certificate file to the UA controller.</p> <ul style="list-style-type: none"> <li>File format must be <b>PEM</b>. Extension name must be "<b>pem / cer / crt</b>".</li> <li>If select a wrong file, the system will show an error message.</li> </ul> <div style="border: 1px solid #ccc; padding: 5px; margin-top: 10px;"> <span>Trusted Certificate</span> <span>Select File</span> <input type="text" value="Certificate_192.168.255.10"/> <span style="color: red;">Certificate type is wrong.</span> <span>Upload</span> </div>
Certificate	<p><b>Select File:</b> select the MQTT Certificate file of the device.</p> <p><b>Upload:</b> upload the MQTT Certificate file to the UA controller.</p> <ul style="list-style-type: none"> <li>File format must be <b>PEM</b>. Extension name must be "<b>pem / cer / crt</b>".</li> <li>If select a wrong file, the system will show an error message.</li> </ul>
Private Key	<p><b>Select File:</b> select the MQTT Private Key of the device.</p> <p><b>Upload:</b> upload the MQTT Private Key file to the UA controller.</p> <ul style="list-style-type: none"> <li>File format must be <b>PEM</b>. Extension name must be "<b>.key</b>".</li> <li>If select a wrong file, the system will show an error message.</li> </ul>

### 5.8.4 Log File Download

This function page is to view and download the Local Data Logger files of the microSD card in the UA series controller.

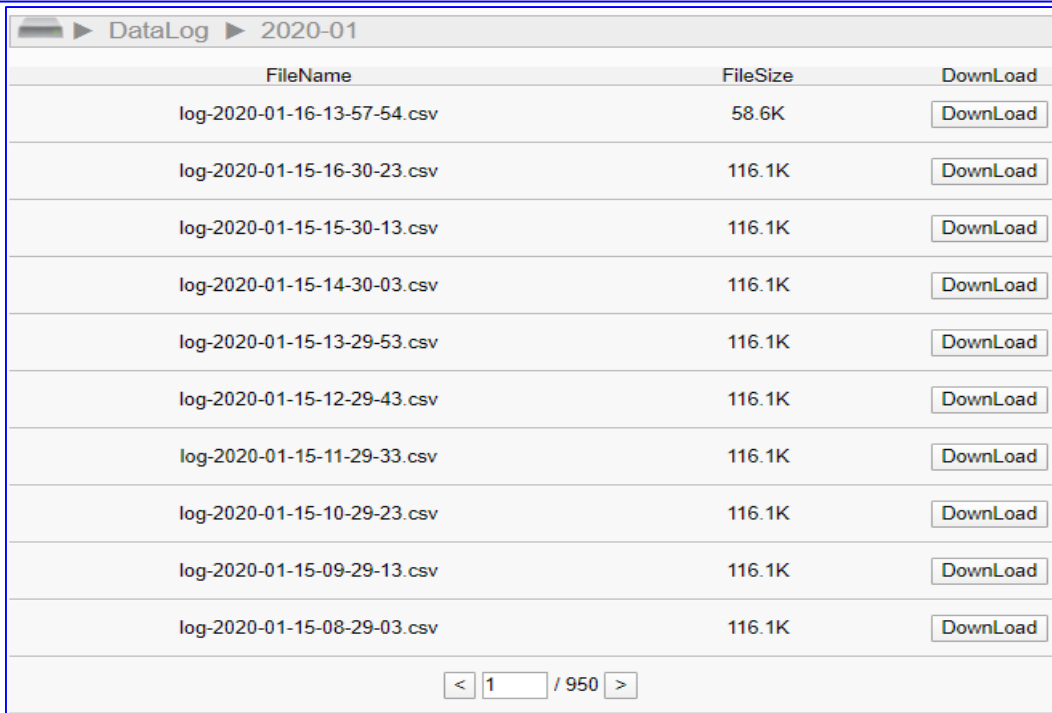
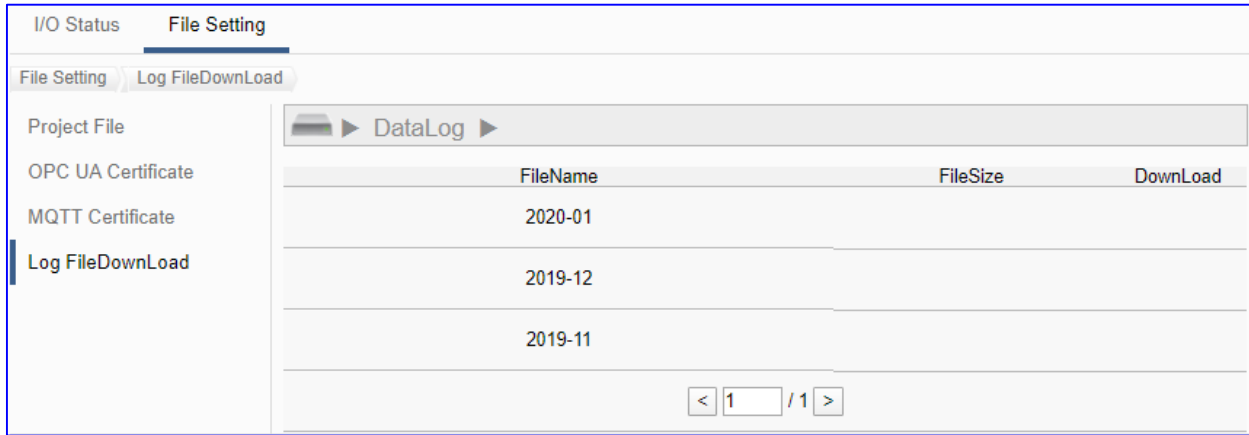

File Setting > Log File Download > DataLog	
File Name	At first, display the year-month folder (e.g. 2020-01), click the year-month folder to list all log files in this month, with the file name "log-YYYY-MM-DD-HH-mm-ss.csv".
File Size	The size of the log file. Unit: KB
Download	Click to download the Log file to the specific folder of the PC.
	The page number of the Log file list: Current page / Total pages. Click < or > to go to the previous or next page.

### 5.8.5 SNMP MIB File

This function is about downloading SNMP MIB files. Users can download all the settings of [Advanced Settings] > [SNMP Agent Settings] into a file for subsequent use.

**SNMP is an advanced function only available on UA-2800 series, UA-5200/2200 series does not support SNMP function.**

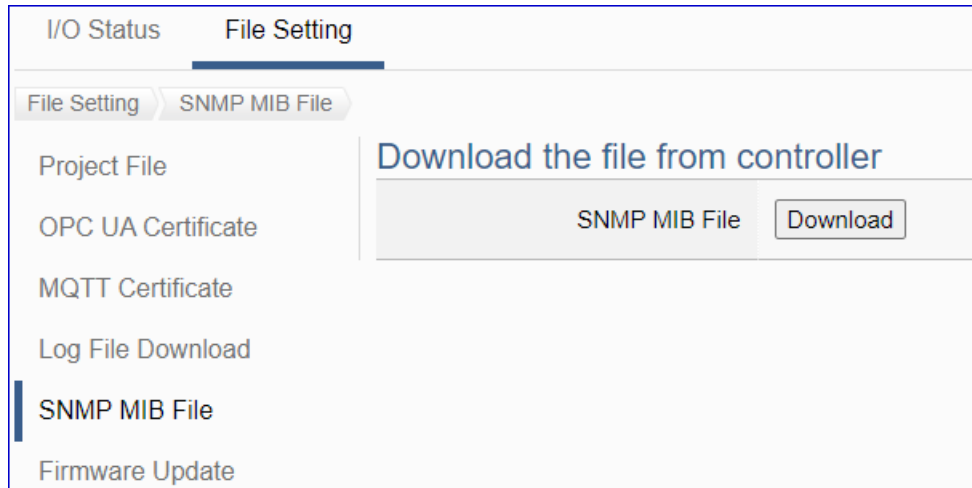

File Setting > SNMP MIB File > Download the file from controller	
SNMP MIB File	Click to download the SNMP MIB file to the specific folder of the PC.

### 5.8.6 Firmware Update

This function is about the update operation of the firmware file, mainly uploading the firmware file to update the version of the UA controller.

Before updating, please download the latest Firmware software file from ICP DAS UA series download center, save it to your computer, and then can upload the file to the UA controller.

**UA series Download Center):**

<https://www.icpdas.com/en/download/index.php?nation=US&kind1=&model=&kw=ua->

**Note: unzip the zip file to “.tar”, DO NOT decompress the “.tar” file again.**

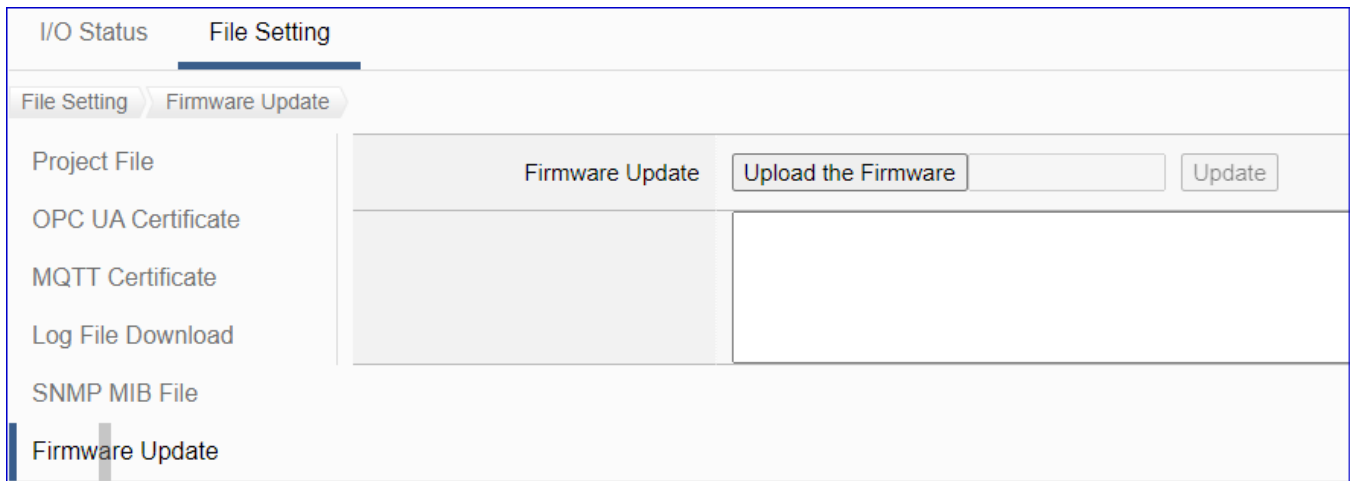
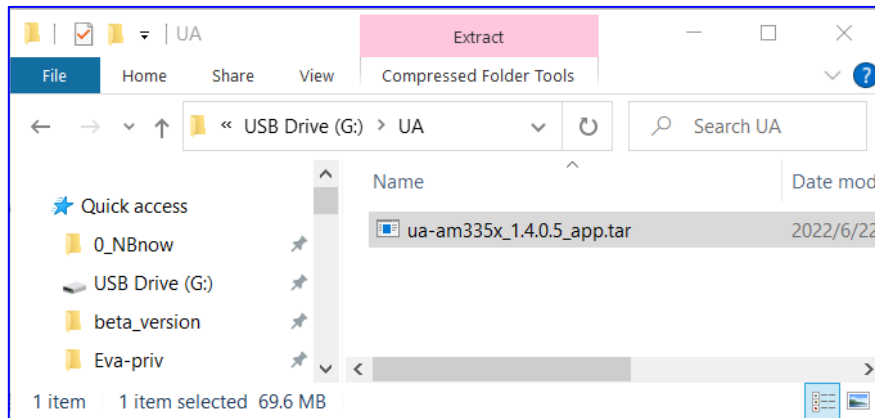

File Setting > Firmware Update	
Upload the Firmware	Go to the UA series download center of the ICP DAS website to download the latest Firmware software file, save it to your computer. <b>Note: unzip the zip file to “.tar”, DO NOT decompress the “.tar” file again.</b> Click “Upload the Firmware” button and select the firmware file.
Update / Information Box	Select the Firmware file and click the “Update” button, it will update the Firmware version automatically. In the update operation, the information box below will display the updating status, and a final message will show if the updating succeeded or failed.

## 6. Factory Setting Recovering and Firmware

### Updating

This chapter will introduce the settings by hardware Rotary Switch, including “Factory Setting Recovering” and “Firmware Updating” that supported since Version 1.0.0.3.

#### 6.1 Recovering to Factory Setting (Rotary Switch: 8)

Switch the Rotary Switch of UA-2800 to “8” to “ON” for recover the UA Series to the factory setting. Before that, first to connect the UA controller via a network cable to a PC or a Switch.

The steps:

1. After connecting the network, power off the UA hardware. Turn the **Rotary Switch** to “8”.
2. Reboot the UA and wait a long buzzer sound that means of doing the recovering.
3. Wait about 3 minutes until **2 long** buzzer sounds, and then turn the Rotary Switch of UA-2800 to “0”.
 

**Note:** If the buzzer makes **4 short** beeps, it means the network is not connected properly. Please check the network cable again.
4. Reboot the UA again, and the system will recover to the factory settings.

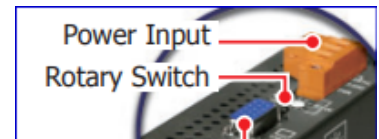

Factory Default Settings of UA Series			
Network	IP	LAN1: 192.168.255.1 LAN2: 10.0.0.1	Assign UA a new IP address according to your case. For UA-2800 series, set the LAN1 for the connection to PC.
	Mask	255.255.0.0	
	Gateway	LAN1: 192.168.1.1 LAN2: 10.168.1.1	
Web UI Account	Username	root	<b>After login, change your password as soon as possible.</b> (Section 5.1.4 for Web UI)
	Password	root	

## 6.2 Updating Firmware A – via Web UI of UA

The user can update firmware via the Web UI function of the UA controller.

Before updating, please download the latest Firmware software file from ICP DAS UA series download center, save it to your computer, and then can upload the file to the UA controller.

### UA series Download Center:

<https://www.icpdas.com/en/download/index.php?nation=US&kind1=&model=&kw=ua->

**Note: DO NOT decompress the firmware file “.tar”.**

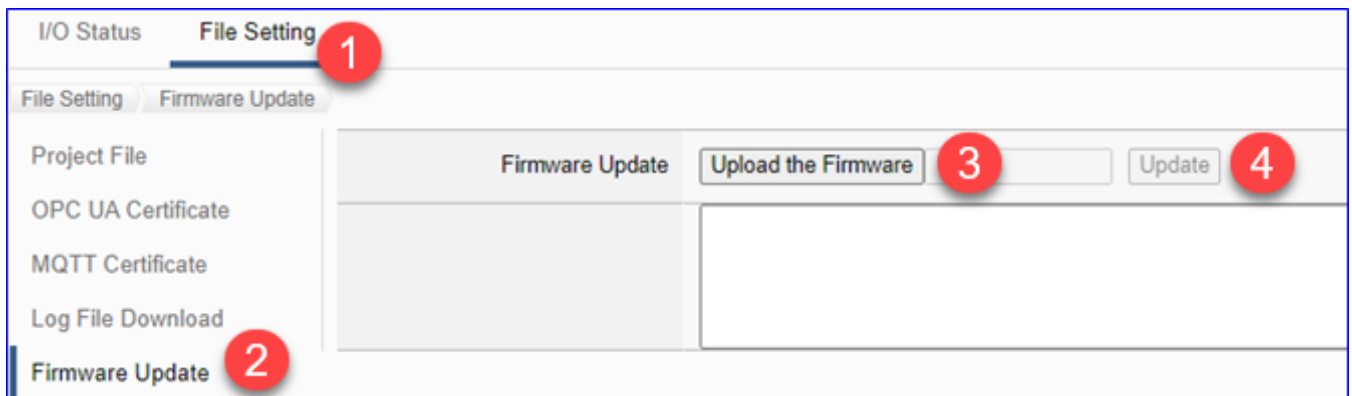
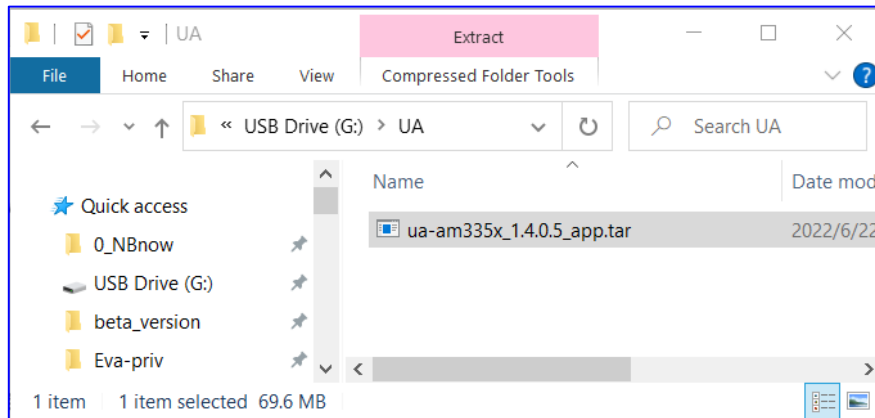

File Setting > Firmware Update	
Upload the Firmware	Go to the UA series download center of the ICP DAS website to download the latest Firmware software file, save it to your computer. <b>Note: DO NOT decompress the firmware file “.tar”.</b> Click “Upload the Firmware” button and select the firmware file.
Update / Information Box	Select the Firmware file and click the “Update” button, it will update the Firmware version automatically. In the update operation, the information box below will display the updating status, and a final message will show if the updating succeeded or failed.

## 6.3 Updating Firmware B - via USB (Rotary Switch: 9)

Turn the Rotary Switch of UA series to “9” can update the Firmware version via USB.

The steps:

1. Power off the UA hardware, and turn the Rotary Switch to “9”.

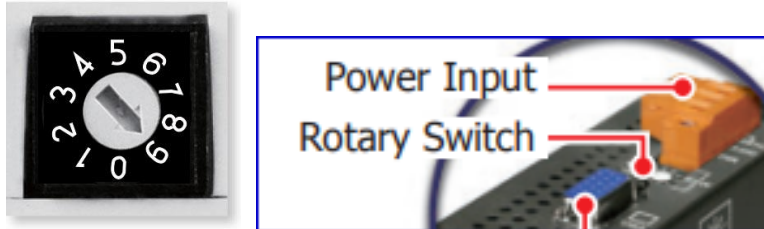

2. Download the Firmware package file of the UA hardware corresponding model.  
UA Download Center:  
<https://www.icpdas.com/en/download/index.php?nation=US&kind1=&model=&kw=ua->
3. Save the Firmware package file into an empty FAT32 format USB drive and put to the UA USB port.
4. Reboot the UA and wait a long buzzer sound that means of doing the version updating.
5. Wait about **three** minutes until **two** long buzzer sounds, and then turn the Rotary Switch to “0”.  
**Note:**  
If the buzzer makes **4 short** beeps, it means the USB may not connected properly.  
Please check the USB again.
6. Reboot the UA again, and the system will update to the version of the package file.

**Note:**

**If the updating Firmware via USB still fails, please refer to nest section for using the MicroSD card to manually update the Firmware version.**

## 7 Security Certificate: Download / Upload

**UA communication security** includes the **username/password protection**, **SSL/TLS secure communication** (Secure Socket Layer / Transport Layer Security), and **OPC UA Server / MQTT Client certificate mechanism** to protect data transmission security.

**OPC UA certificate** provides the certificate exchange with **Server and Client** side to authenticate each other **through the x.509 certificate** to protect the data transmission security. OPC UA **default enables** encryption and security mechanisms with advanced processing, **including: Authentication, Authorization, Confidentiality and Integrity.**

**MQTT certificate** provides three certificate types: **Trusted Certificate, Certificate, and Private Key.** Depending on the type of certificate obtained to perform the **Broker verification** or **Broker/Client mutual verification.** It supports identity verification and data encryption, and provides a secure connection. mechanism.

- **OPC UA Server Certificate management**

**UA controller supports OPC UA Server security connection, including identity authentication, data encryption, data signature. Server and Client authenticate each other through x.509 certificate.**

There are 3 items in OPC UA Certificate: Remove, Upload and Download the Certificate file.

Download is for providing the OPC UA Server certificate to the other side.

Upload is to save the other's trust certificate into the UA. So before uploading, please get the certificate file of the other side device first. Please refer to 7.2.1 for details.

- **MQTT Client Certificate management**

**UA controller supports MQTT Client secure encrypted certificate file management. There are three types of files: Trusted Certificate, Certificate, and Private Key.** The users upload the file to the UA controller according to the type of obtained certificate. If you want to perform **Broker authentication**, you need to upload the **Trusted Certificate.** If you want to perform the **Broker/Client two-way authentication**, you need to upload the **Credential and Private Key additionally.**

Therefore, before uploading, you must confirm the required verification method, obtain the required certificate file, and store it in your computer before you can configure the upload certificate. Please refer to 7.2.2 for details.

The upload and download of OPC UA and MQTT Certificates are in the main menu [**File Setting**]. Before setting this function, you need to download or upload the relevant certificates. This chapter is divided into two sections, download/upload, to explain the setting steps and notices.

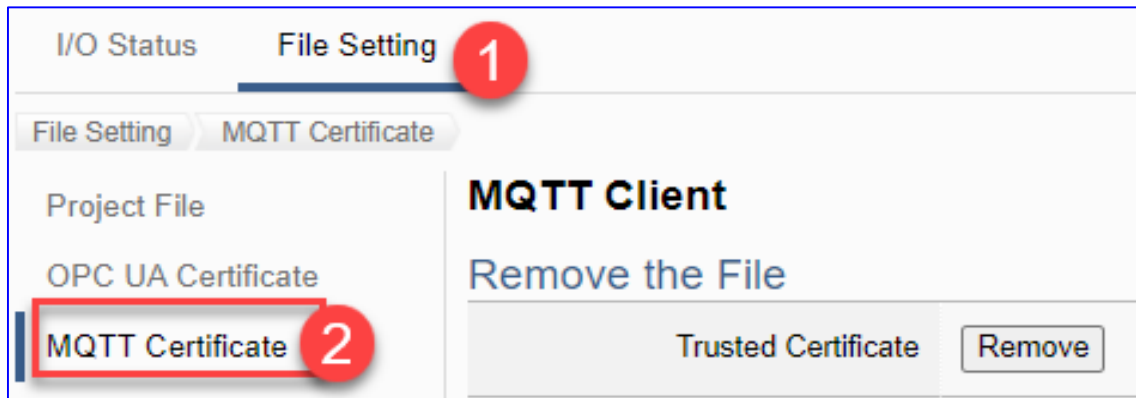
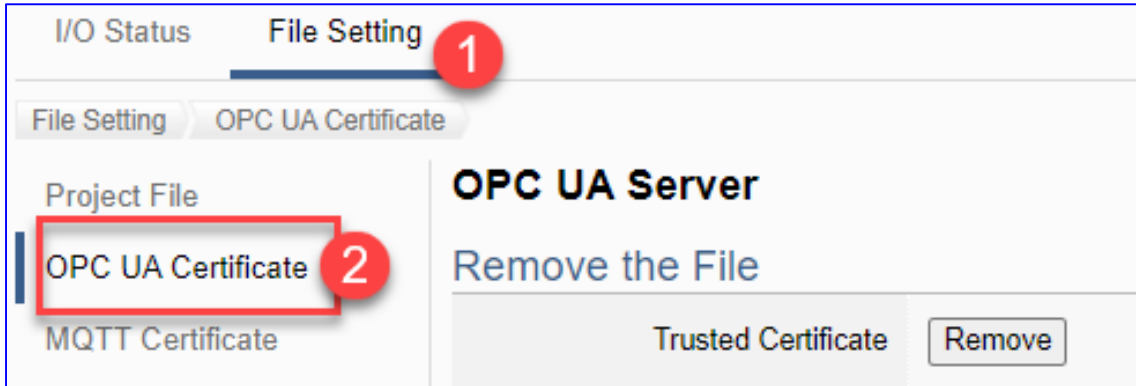

7.1 Download the Certificate from UA Controller

7.2 Upload the Certificate to UA Controller

7.2.1 OPC UA Certificate

7.2.2 MQTT Certificate

## 7.1 Download the Certificate from UA Controller

Download is for providing the OPC UA Server certificate to the other side.

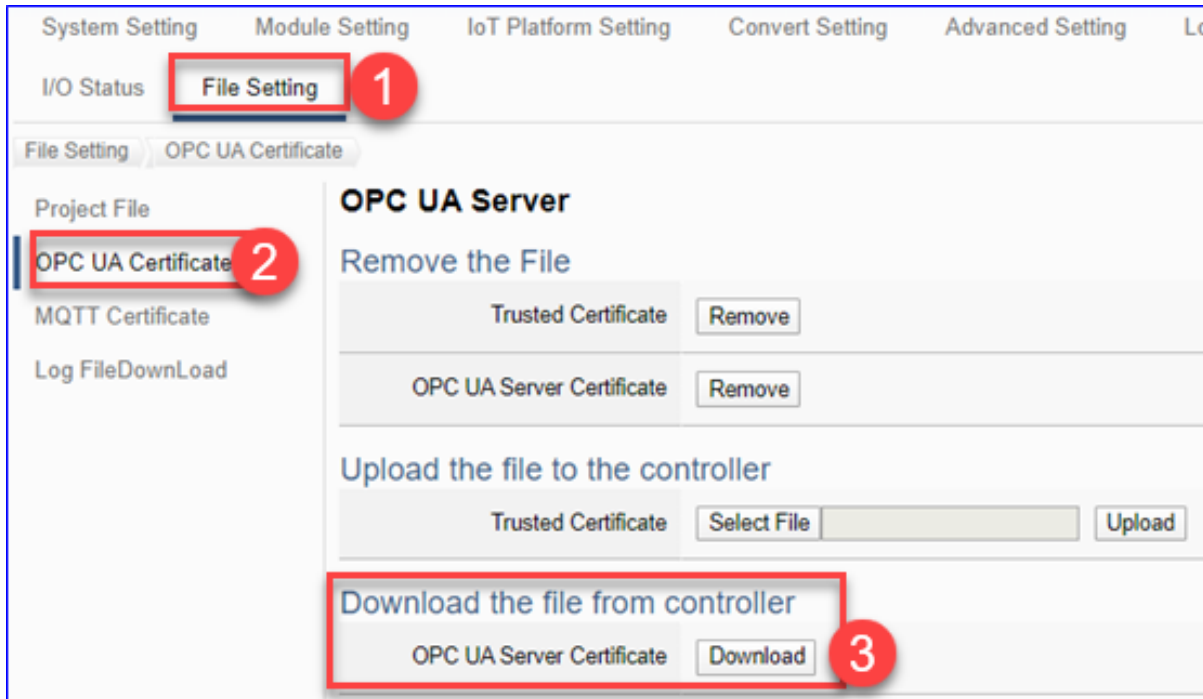

1. Click the main menu [ **1 File Setting** > **2 OPC UA Certificate** > **Download the file from the controller** – OPC UA Server Certificate] and then click on the button **3 [Download]**.
2. Save the OPC UA Server certificate file to your designated folder. The downloaded certificate file (\*.tar) of the UA series controller looks similar to the figure below.

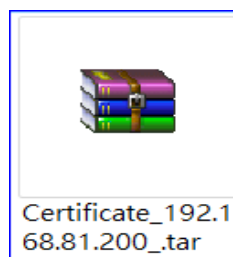

## 7.2 Upload the Certificate to UA Controller

The user can store trusted certificates of the OPC UA client or the MQTT Broker from other device into the UA project for setting up security communications.

### 7.2.1 OPC UA Certificate

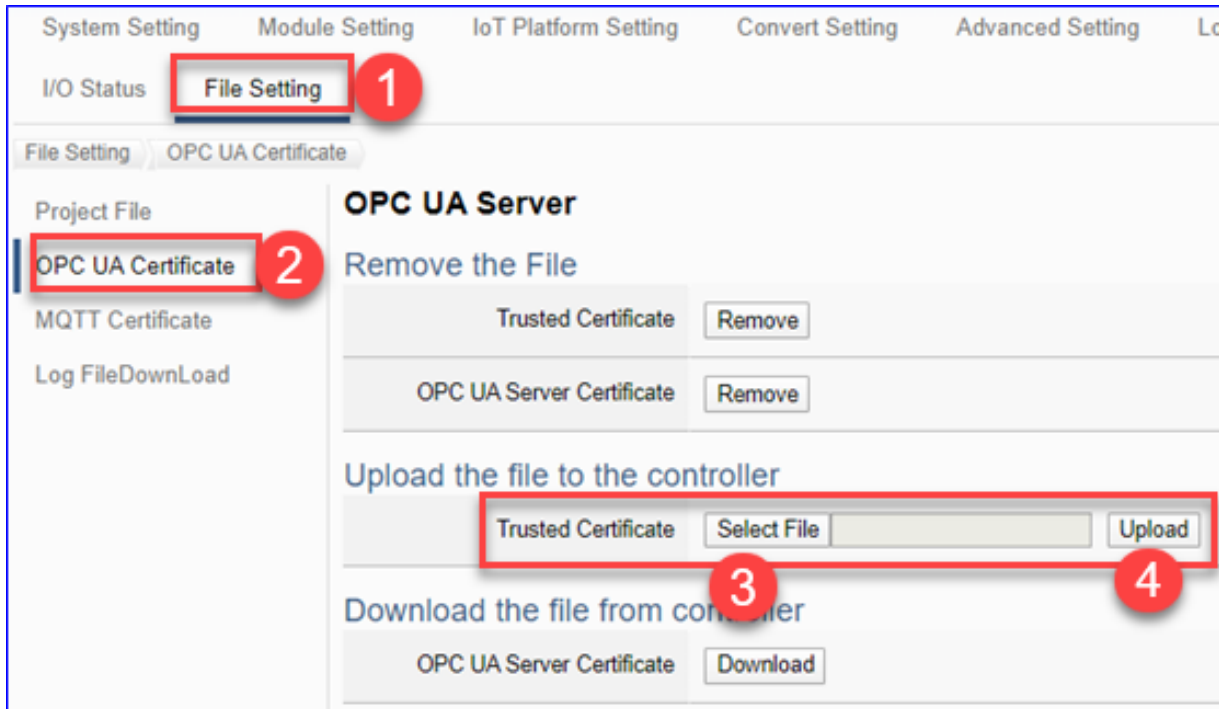

1. Get the trusted certificates from OPC UA Client and save in the PC.
2. Click the main menu [①File Setting > ② OPC UA Certificate > Upload the file to the controller – Trusted Certificate], click on the button ③ [Select File] to select the trusted certificates from OPC UA Client.
3. Click the button ④ [Upload], then can upload and exchange the certificate authentication.

#### Notes for OPC UA Certificate:

- The supported code format: “**DER**”.
- The supported file extension name: “**\*.der / \*.cer / \*.crt**” .
- The OPC UA Server Certificate downloaded from UA series:

File name: **Certificate\_IP-address\_.tar**, e.g.  Certificate\_192.168.255.102\_.tar

Before using, decompress to **icpdasuserver.der**, e.g.  icpdasuserver.der

- Refer to [5.8.2](#) for detail parameter descriptions.

## 7.2.2 MQTT Certificate

If you want to perform **Broker authentication**, you need to upload the **Trusted Certificate**. If you want to perform the **Broker/Client two-way authentication**, you need to upload the **Credential and Private Key** additionally.

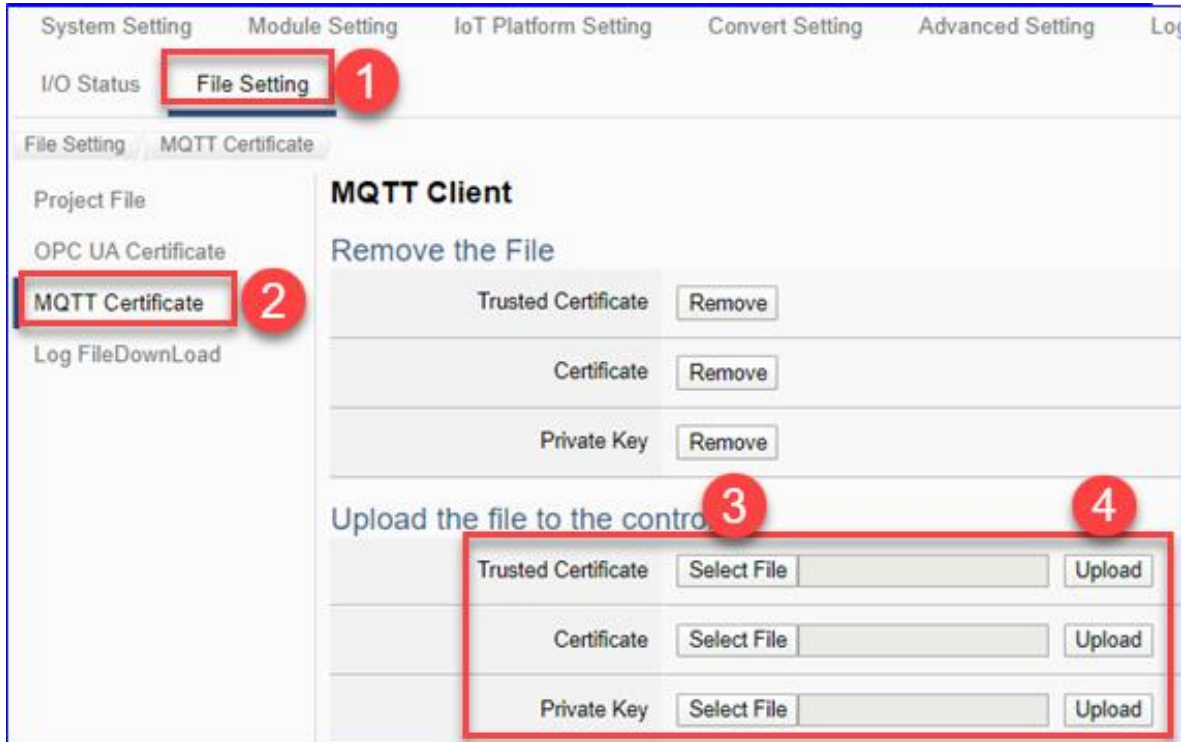

1. Get the trusted certificates from MQTT Client and save in the PC.
2. Click the main menu [ ① **File Setting** > ② **MQTT Certificate** > **Upload the file to the controller – Trusted Certificate / Certificate / Private Key**], click on the button ③ [**Select File**] to select the Trusted Certificate, Certificate or Private Key from MQTT Client.
3. Click the button ④ [**Upload**], then UA system can exchange the certificate authentication.

### Notes for MQTT Client Certificate:

- The supported code format: **“PEM”**.
- The supported file extension name for Certificates: **“\*.pem / \*.cer / \*.cert”**.
- The supported file extension name for Private Key: **“\*.key”**.
- Refer to [5.8.3](#) for detail parameter descriptions.

# Appendix A. MQTT JSON Format of the UA Series

## MQTT JSON Example & Format Descriptions:

```
{
  "Variable" : [ {
    "Name" : "Bool_R[0]",
    "Attribute" : "R",
    "Datatype" : "Bool",
    "Value" : 0,
    "Quality" : "Uncertain"
  }, {
    "Name" : "Short_R[0]",
    "Attribute" : "R",
    "Datatype" : "Int16",
    "Value" : 0,
    "Quality" : "Uncertain"
  }, {
    "Name" : "Short_R[1]",
    "Attribute" : "R",
    "Datatype" : "Int16",
    "Value" : 0,
    "Quality" : "Uncertain"
  }, {
    "Name" : "Short_R[2]",
    "Attribute" : "R",
    "Datatype" : "Int16",
    "Value" : 0,
    "Quality" : "Uncertain"
  }, {
    "Name" : "Short_RW[2]",
    "Attribute" : "RW",
    "Datatype" : "Int16",
    "Value" : 0,
    "Quality" : "Uncertain"
  }
]
```

Name	Descriptions
Variable	The array name of JSON. Its structure includes several member data as below.
Name	The member name of the array element
Attribute	The member attribute of the array element: "R" : can read "W" : can write "RW" : can read and write
Datatype	The member's data type of the array element: "Bool" "Int8" "UInt8" "UInt16" "Int16" "UInt32" "Int32" "UInt64" "Int64" "Float" "Double" "String"
Value	The member's current value of the array element
Quality	The member's current status of the array element: "Uncertain" "Good" "Bad"

## Appendix B. Protocol Technical Reference

- **OPC UA**

<https://opcfoundation.org/>

- **MQTT**

<http://mqtt.org/>

- **Modbus**

<http://modbus.org/>

## Appendix C. LED Indicators

LED indicators of UA Series provide a very convenient way of status indications for faster, easier diagnostics.



UA-2841M		
LED	LED Status	Module Status
PWR	Green: ON	The module is powered on.
RUN	Red: ON	The system is functioning normally. <i>When power on UA, please wait about 30 seconds to complete the start-up procedure until the "RUN" LED starts ON.</i>
L1 / L3	OFF	Function reserved
L2	Yellow: Blinking, then ON, and then OFF.	When install or update the Firmware, L2 will blinking. When complete the process, L2 will steady ON to notify user and then OFF.

## Appendix D. Mounting the XV-board for UA Series

### XV-board Expansion Module Supported List of UA Series :

XV-board Type	XV-board Model	Supported UA Model
I/O Expansion	XV107, XV110, XV111, XV116, XV119, XV303, XV306, XV307, XV310	UA-2200 / 5200 / 2800 Series
RS-485 Expansion	XV511i	UA-2241M, UA-2841M, UA-5231, UA-5231M

For more detailed information about the all XV-board specifications, please refer to the [XV-board Expansion Module](#).

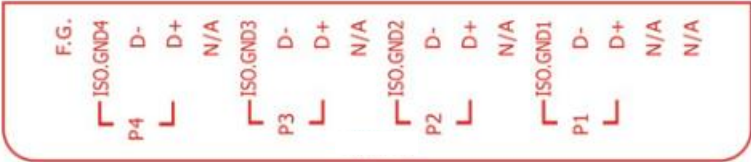
Model	Descriptions
XV511i	<p>4-channel RS-485 I/O Expansion Board (RoHS)</p> <p>PIN Assignment:</p>  <p>P4: ttyO9    P3: ttyO8    P2: ttyO7    P1: ttyO6</p>

## Mounting Steps For UA-2841M Series

UA-2841M has one I/O expansion bus to expand the functions by insert one optional XV-board. The supported XV-boards are listed after the mounting steps below.

### Mounting Steps:

#### Step 1: Remove stripped screws and then remove the cover

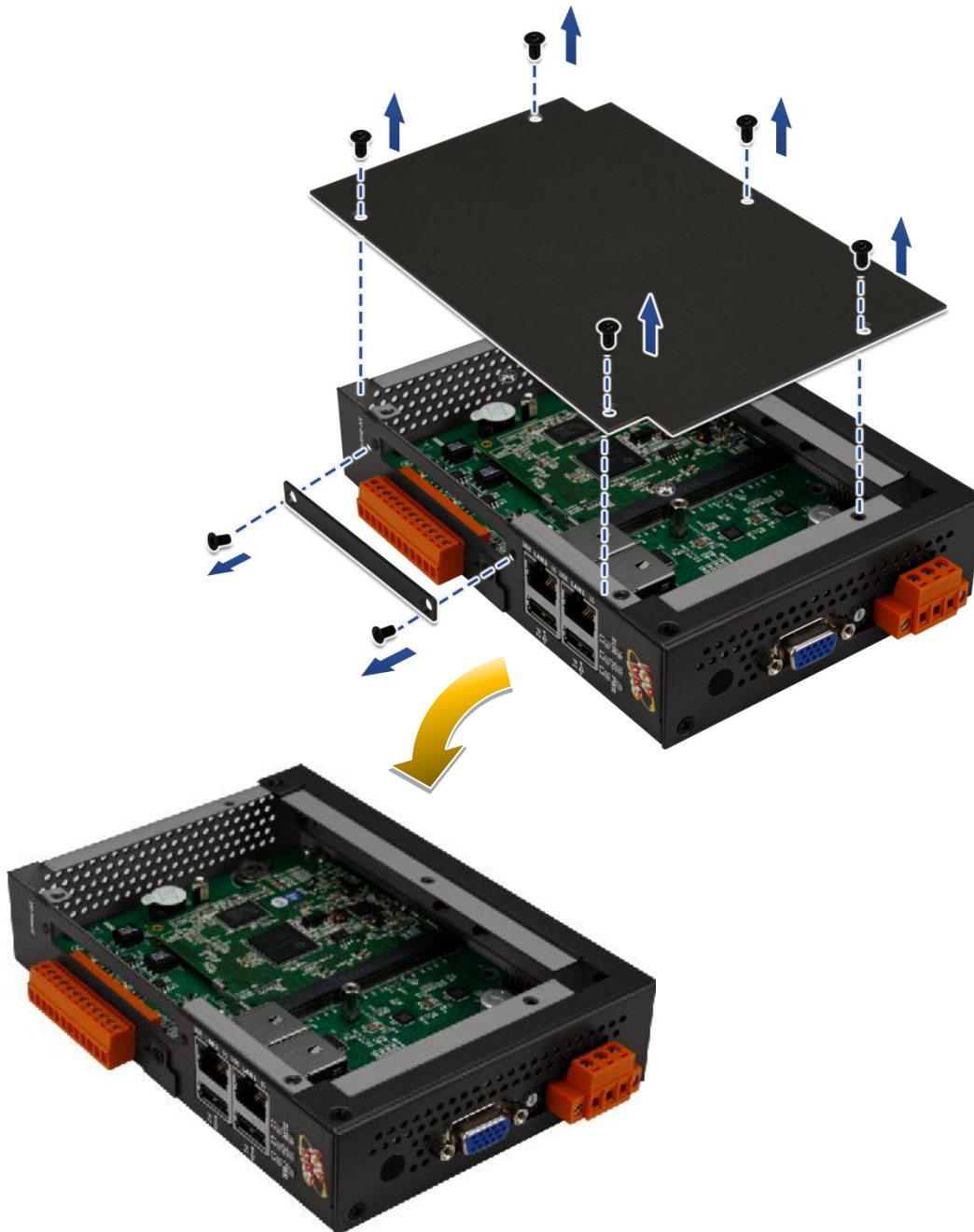

**Step 2: Hold the XV-board vertically and align the socket, and then carefully press the XV-board onto the I/O expansion bus**

**Step 3: Fasten the XV-board using the screws supplied**



**Step 4: Close the cover and then fasten the screws**

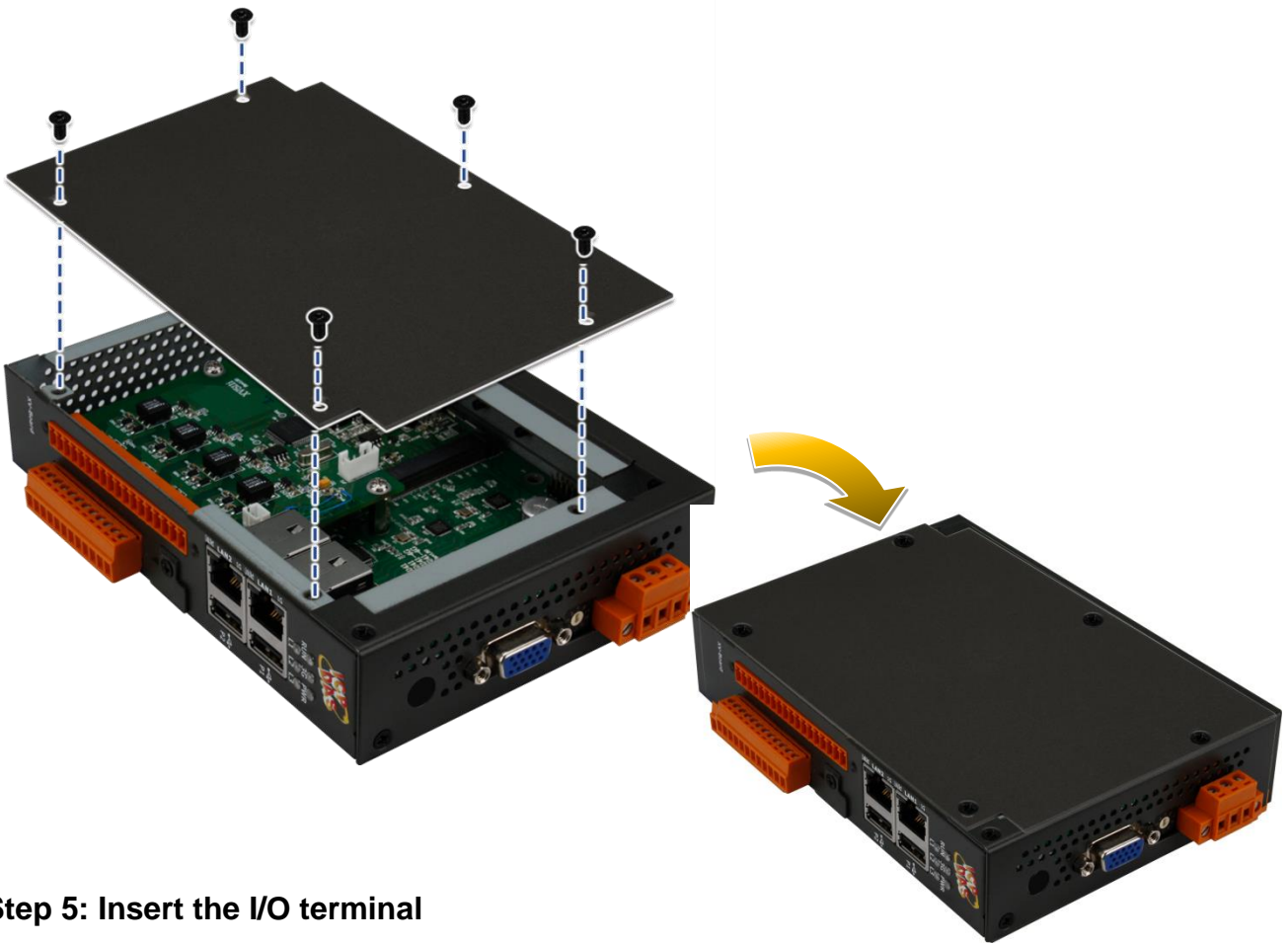

**Step 5: Insert the I/O terminal**

