

DN-831I-100V Series



DNM-831I-100V Series



DNM-831I-600V Series



1 Channel Voltage Attenuator and 1 Channel Current Transformer

Features

- High Voltage Input and High Current Input Measurement
- Three Way Isolation
- Linear Attenuation Ratio
- High Input Impedance
- Easily wire connection



Introduction

The DN(M)-831I series is 1-channel voltage attenuator and 1-channel current transformer. The maximum voltage input range is from ± 600 V can be attenuated to ± 10 V and the maximum current input range is from ± 2000 A can be attenuated to ± 10 V. It provides 3000 Vdc intra-modules isolation and 3000 Vdc channel to channel isolation to avoid the noise interference from inputs to outputs or channel to channel. It can be used with the analog input modules such as I-7017, I-87017, M-7017RMS and I-87017W-RMS etc. to measure the high current.

Applications

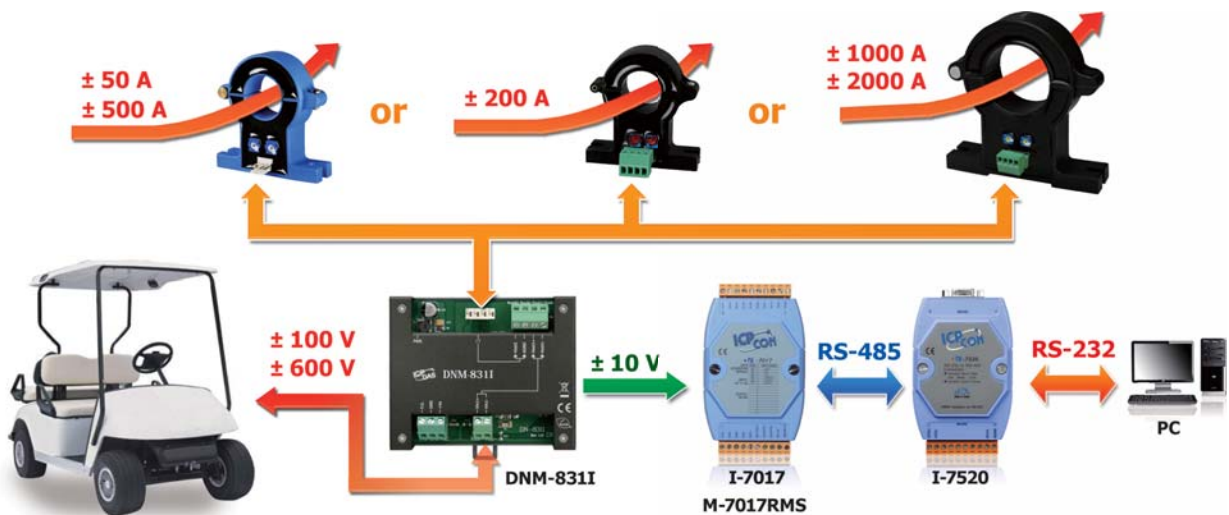

Appearance

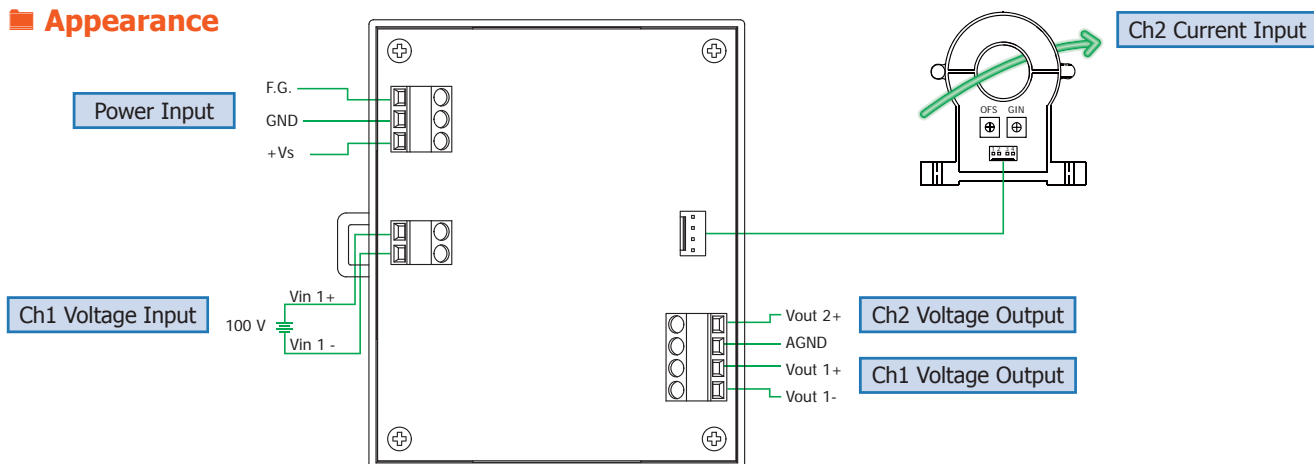

Specifications

Models	DN-831I-100V-50A	DN-831I-100V-200A	DN-831I-100V-500A	DN-831I-100V-1000A	DN-831I-100V-2000A
	DNM-831I-100V-50A	DNM-831I-100V-200A	DNM-831I-100V-500A	DNM-831I-100V-1000A	DNM-831I-100V-2000A
	DNM-831I-600V-50A	DNM-831I-600V-200A	DNM-831I-600V-500A	DNM-831I-600V-1000A	DNM-831I-600V-2000A
High Current Input					
Channels	1				
Input Type	AC/DC Current				
Input Current Range	±50 A	±200 A	±500 A	±1000 A	±2000 A
Output Voltage Range	±10 V				
Accuracy	1% of FSR				
Response time	150 μs				
Isolation voltage	2.5 KV @ 50 (60) HZ/1 min				
Frequency bandwidth	0 ~ 50 KHz				
CTΦ	Φ21 mm			Φ40.5 mm	
High Voltage Input					
Channel	1				
Input Type	AC/DC Voltage				
Input Range	DN-831I-100V series: ±100 V DNM-831I-100V series: ±100 V DNM-831I-600V series: ±600 V				
Output Range	±10 V				
Accuracy	1% of FSR				
Response time	15 μs				
Frequency bandwidth	20 Hz ~ 20 kHz				
Isolation					
Three Way Isolation	3000 VDC				
EMS Protection					
ESD (IEC 61000-4-2)	±4 kV contact for power line, input and output channels, ±8 kV air for random point				
Surge (IEC 61000-4-5)	±2 kV for power liner				
Power Input					
Input Range	+10 ~ +30 VDC				
Power Consumption	1.8 W				
Mechanical					
Casing	DN-831I-100V series: Plastic DNM-831I-100V series: Metal DNM-831I-600V series: Metal				
Dimensions (W x L x D)	DN-831I-100V series: 103 mm x 94 mm x 29 mm DNM-831I-100V series: 103 mm x 93 mm x 29 mm DNM-831I-600V series: 103 mm x 97 mm x 29 mm				
Installation	DIN-Rail Mounting				
Environment					
Operating Temperature	-25 ~ +75°C				
Storage Temperature	-30 ~ +75°C				
Humidity	10 ~ 90% RH (non-condensing)				

■ Dimensions (Units: mm)

DN-831I -100V

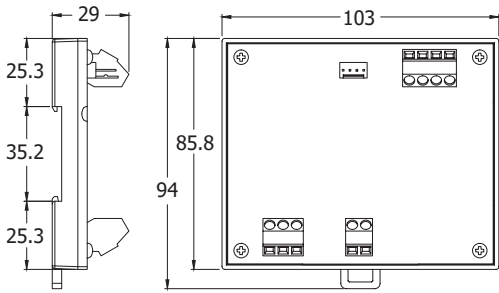

Left View

Front View



Right View

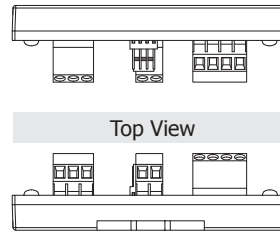

Top View

Bottom View

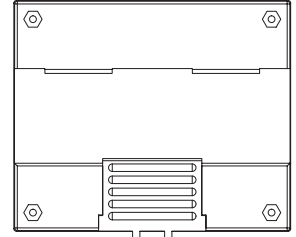

Right View

DNM-831I -100V

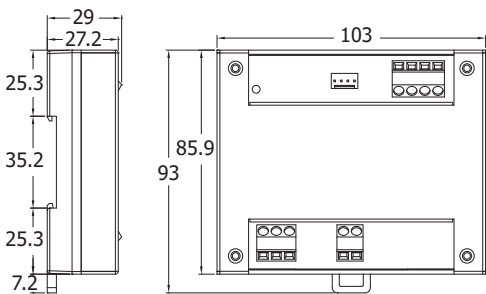

Left View

Front View

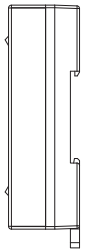

Right View

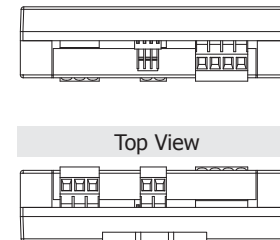

Top View

Bottom View

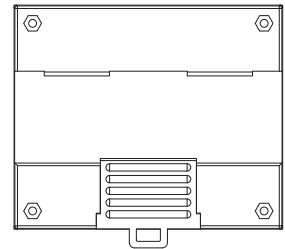

Right View

DNM-831I-600V

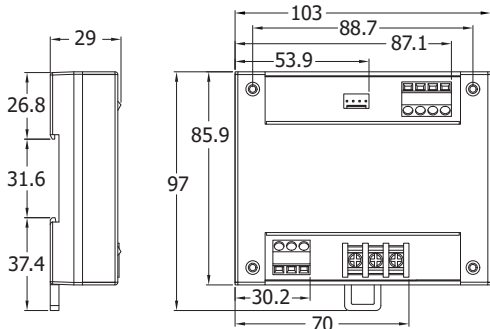

Left View

Front View

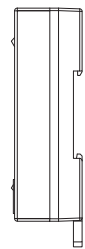

Right View

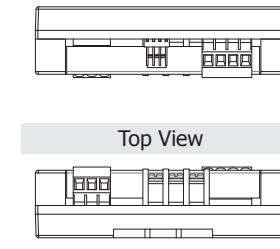

Top View

Bottom View

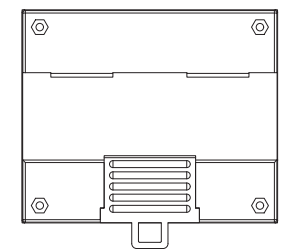

Right View

50A, 200A, 500A CTΦ21mm

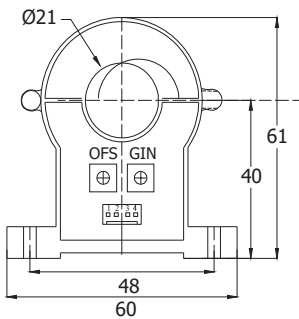

Front View

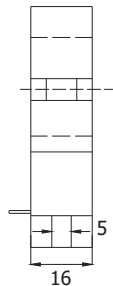

Right View

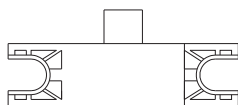

Bottom View

1000A, 2000A CTΦ40.5mm

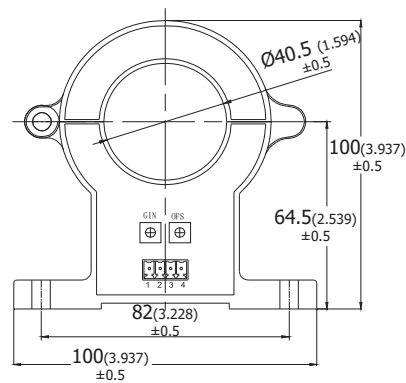

Front View

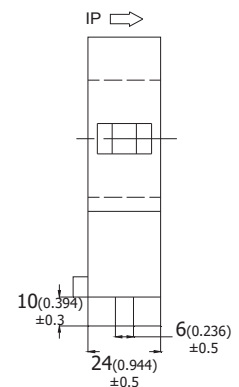

Right View

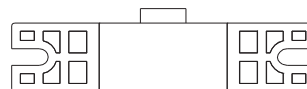

Bottom View







TB1 Pin Assignments

TB1-1:	+15V	RED
TB1-2:	-15V	BLACK
TB1-3:	Output	GREEN
TB1-4:	GND	WHITE

Ordering Information

DN-831I-100V-50A CR	1 Channel Voltage Attenuator (100V) and 1 Channel CT (50A) (RoHS) Includes CA-040415 Cable and ASO-0002 Current Transformer
DN-831I-100V-200A CR	1 Channel Voltage Attenuator (100V) and 1 Channel CT (200A) (RoHS) Includes CA-040415-1 Cable and ASO-003-1 Current Transformer
DN-831I-100V-500A CR	1 Channel Voltage Attenuator (100V) and 1 Channel CT (500A) (RoHS) Includes CA-040415 Cable and ASO-0001 Current Transformer
DN-831I-100V-1000A CR	1 Channel Voltage Attenuator (100V) and 1 Channel CT (1000A) (RoHS) Includes CA-040415-1 Cable and ASO-0024 Current Transformer
DN-831I-100V-2000A CR	1 Channel Voltage Attenuator (100V) and 1 Channel CT (2000A) (RoHS) Includes CA-040415-1 Cable and ASO-0025 Current Transformer
DNM-831I-100V-50A CR	1 Channel Voltage Attenuator (100V) and 1 Channel CT (50A) (Metal) (RoHS) Includes CA-040415 Cable and ASO-0002 Current Transformer
DNM-831I-100V-200A CR	1 Channel Voltage Attenuator (100V) and 1 Channel CT (200A) (Metal) (RoHS) Includes CA-040415-1 Cable and ASO-0003-1 Current Transformer
DNM-831I-100V-500A CR	1 Channel Voltage Attenuator (100V) and 1 Channel CT (500A) (Metal) (RoHS) Includes CA-040415 Cable and ASO-0001 Current Transformer
DNM-831I-100V-1000A CR	1 Channel Voltage Attenuator (100V) and 1 Channel CT (1000A) (Metal) (RoHS) Includes CA-040415-1 Cable and ASO-0024 Current Transformer
DNM-831I-100V-2000A CR	1 Channel Voltage Attenuator (100V) and 1 Channel CT (2000A) (Metal) (RoHS) Includes CA-040415-1 Cable and ASO-0025 Current Transformer
DNM-831I-600V-50A CR	1 Channel Voltage Attenuator (600V) and 1 Channel CT (50A) (Metal) (RoHS) Includes CA-040415 Cable and ASO-0002 Current Transformer
DNM-831I-600V-200A CR	1 Channel Voltage Attenuator (600V) and 1 Channel CT (200A) (Metal) (RoHS) Includes CA-040415-1 Cable and ASO-0003-1 Current Transformer
DNM-831I-600V-500A CR	1 Channel Voltage Attenuator (600V) and 1 Channel CT (500A) (Metal) (RoHS) Includes CA-040415 Cable and ASO-0001 Current Transformer
DNM-831I-600V-1000A CR	1 Channel Voltage Attenuator (600V) and 1 Channel CT (1000A) (Metal) (RoHS) Includes CA-040415-1 Cable and ASO-0024 Current Transformer
DNM-831I-600V-2000A CR	1 Channel Voltage Attenuator (600V) and 1 Channel CT (2000A) (Metal) (RoHS) Includes CA-040415-1 Cable and ASO-0025 Current Transformer

Accessories

 CA-040415-1	4-pin & 4-pin Cable 1.5 M for Hall Current Sensor 200A/1000A/2000A (RoHS)	 CA-040415-1 Cable & Current Transformer (Terminal Block)
 CA-040415	4-pin & 4-pin Cable 1.5 M for Hall Current Sensor 50A/500A (RoHS)	 CA-040415/25/100 Cable & Current Transformer (Lock Connector)
 CA-040425	4-pin & 4-pin Cable 2.5 M for Hall Current Sensor 50A/500A (RoHS)	
 CA-0404100	4-pin & 4-pin Cable 10 M for Hall Current Sensor 50A/500A (RoHS)	